



BUREAU VERITAS

Test Report No.: CE2312WDG0186



TEST REPORT



Applicant	Huawei Technologies Co., Ltd.
Address	Administration Building, Headquarters of Huawei Technologies Co., Ltd., Bantian, Longgang District, Shenzhen, Guangdong, 518129, China.

Manufacturer or Supplier	Huawei Technologies Co., Ltd.	
Address	Administration Building, Headquarters of Huawei Technologies Co., Ltd., Bantian, Longgang District, Shenzhen, Guangdong, 518129, China.	
Product	SOLAR INVERTER	
Brand Name	HUAWEI	
Model	SUN2000-100KTL-M1, SUN2000-115KTL-M2	
Additional Model & Model Difference	SUN2000-100KTL-INM0, SUN2000-75KTL-M1, SUN2000-100KTL-M2, SUN2000-110KTL-M2; See item 2.1	
Date of tests	Aug. 20, 2019 ~ Aug. 30, 2019 Oct. 21, 2020 ~ Nov. 02, 2020 Aug. 19, 2022 ~ Sep. 27, 2022 Aug. 04, 2023 ~ Aug. 20, 2023	

The submitted sample of the above equipment has been tested for according to the requirements of the following standards:

<input checked="" type="checkbox"/> EN 62920:2017+A11:2020	<input checked="" type="checkbox"/> EN 62920:2017+A1:2021	<input checked="" type="checkbox"/> IEC 62920:2017+AMD1:2021
<input checked="" type="checkbox"/> EN 55011:2016 + A2:2021 (Group 1)	<input checked="" type="checkbox"/> CISPR11:2015+AMD1:2016+AMD2 :2019 (Group 1)	
<input checked="" type="checkbox"/> EN IEC61000-6-3:2021 (Telecom Port)	<input checked="" type="checkbox"/> IEC 61000-6-3:2020 (Telecom Port)	
<input checked="" type="checkbox"/> EN IEC 61000-6-4:2019 (Telecom Port)	<input checked="" type="checkbox"/> IEC 61000-6-4:2018 (Telecom Port)	
<input checked="" type="checkbox"/> EN 61000-3-12:2011	<input checked="" type="checkbox"/> IEC 61000-3-12:2011	
<input checked="" type="checkbox"/> EN IEC 61000-3-11:2019	<input checked="" type="checkbox"/> IEC 61000-3-11:2017	
<input checked="" type="checkbox"/> EN IEC 61000-6-1:2019	<input checked="" type="checkbox"/> IEC 61000-6-1:2016	
<input checked="" type="checkbox"/> EN IEC 61000-6-2:2019	<input checked="" type="checkbox"/> IEC 61000-6-2:2016	

CONCLUSION: The submitted sample was found to COMPLY with the test requirement

Tested by Eric Fang Project Engineer / EMC Department	Approved by Madison Luo Assistant Manager / EMC Department
	
	Date: Jan. 05, 2024

This report is governed by, and incorporates by reference, the Conditions of Testing as posted at the date of issuance of this report at <http://www.bureauveritas.com/home/about-us/our-business/cps/about-us/terms-conditions/> and is intended for your exclusive use. Any copying or replication of this report to or for any other person or entity, or use of our name or trademark, is permitted only with our prior written permission. This report sets forth our findings solely with respect to the test samples identified herein. The results set forth in this report are not indicative or representative of the quality or characteristics of the lot from which a test sample was taken or any similar or identical product unless specifically and expressly noted. Our report includes all of the tests requested by you and the results thereof based upon the information that you provided to us. Measurement uncertainty is only provided upon request for accredited tests. Statements of conformity are based on simple acceptance criteria without taking measurement uncertainty into account, unless otherwise requested in writing. You have 60 days from date of issuance of this report to notify us of any material error or omission caused by our negligence or if you require measurement uncertainty; provided, however, that such notice shall be in writing and shall specifically address the issue you wish to raise. A failure to raise such issue within the prescribed time shall constitute your unqualified acceptance of the completeness of this report, the tests conducted and the correctness of the report contents.



Table of Contents

RELEASE CONTROL RECORD	5
1 SUMMARY OF TEST RESULTS	6
1.1 MEASUREMENT UNCERTAINTY	9
2 GENERAL INFORMATION	10
2.1 GENERAL DESCRIPTION OF EUT	10
2.2 DESCRIPTION OF TEST MODES	12
2.3 GENERAL DESCRIPTION OF APPLIED STANDARDS	21
2.4 DESCRIPTION OF SUPPORT UNITS	22
3 EMISSION TEST	23
3.1 CONDUCTED EMISSION MEASUREMENT AT MAIN PORT	23
3.1.1 LIMITS OF CONDUCTED EMISSION MEASUREMENT AT MAIN PORT	23
3.1.2 TEST INSTRUMENTS	25
3.1.3 TEST PROCEDURE	26
3.1.4 DEVIATION FROM TEST STANDARD	26
3.1.5 TEST SETUP	27
3.1.6 EUT OPERATING CONDITIONS	27
3.1.7 TEST RESULTS	28
3.2 CONDUCTED EMISSION MEASUREMENT AT TELECOMMUNICATION PORTS	57
3.2.1 LIMIT OF CONDUCTED COMMON MODE DISTURBANCE AT TELECOMMUNICATION PORTS	57
3.2.2 TEST INSTRUMENTS	57
3.2.3 TEST PROCEDURE	58
3.2.4 DEVIATION FROM TEST STANDARD	59
3.2.5 TEST SETUP	60
3.2.6 EUT OPERATING CONDITIONS	61
3.2.7 TEST RESULTS	62
3.3 RADIATED EMISSION MEASUREMENT	64
3.3.1 LIMITS OF RADIATED EMISSION MEASUREMENT	64
3.3.2 TEST INSTRUMENTS	65
3.3.3 TEST PROCEDURE	66
3.3.4 DEVIATION FROM TEST STANDARD	66
3.3.5 TEST SETUP	67
3.3.6 EUT OPERATING CONDITIONS	67
3.3.7 TEST RESULTS	68
3.4 HARMONICS CURRENT MEASUREMENT (>16A)	73
3.4.1 TEST INSTRUMENTS	73
3.4.2 CURRENT EMISSION LIMITS FOR EQUIPMENT OTHER THAN BALANCED THREE-PHASE EQUIPMENT	74
3.4.3 CURRENT EMISSION LIMITS FOR BALANCED THREE-PHASE EQUIPMENT	75
3.4.4 CURRENT EMISSION LIMITS FOR BALANCED THREE-PHASE EQUIPMENT UNDER SPECIFIED CONDITIONS	75



3.4.5 DEVIATION FROM TEST STANDARD.....75

3.4.6 TEST SETUP.....76

3.4.7 EUT OPERATING CONDITIONS76

3.4.8 TEST RESULTS77

3.5 VOLTAGE FLUCTUATION AND FLICKS MEASUREMENT.....104

3.5.1 LIMITS OF VOLTAGE FLUCTUATION AND FLICKS MEASUREMENT104

3.5.2 TEST INSTRUMENTS.....105

3.5.3 TEST PROCEDURE.....106

3.5.4 DEVIATION FROM TEST STANDARD.....106

3.5.5 TEST SETUP.....107

3.5.6 EUT OPERATING CONDITIONS107

3.5.7 TEST RESULTS108

4 IMMUNITY TEST117

4.1 GENERAL DESCRIPTION117

4.1.1 GENERAL DESCRIPTION117

4.1.2 PERFORMANCE CRITERIA119

4.1.3 EUT OPERATING CONDITION.....120

4.2 ELECTROSTATIC DISCHARGE IMMUNITY TEST (ESD) (EN IEC 61000-6-2 & EN 62920).....121

4.2.1 TEST SPECIFICATION121

4.2.2 TEST INSTRUMENTS.....121

4.2.3 TEST PROCEDURE.....122

4.2.4 DEVIATION FROM TEST STANDARD.....122

4.2.5 TEST SETUP.....123

4.2.6 TEST RESULTS125

4.3 RADIATED, RADIO-FREQUENCY, ELECTROMAGNETIC FIELD.....128

IMMUNITY TEST (RS) (EN IEC 61000-6-2 & EN 62920).....128

4.3.1 TEST SPECIFICATION128

4.3.2 TEST INSTRUMENTS.....128

4.3.3 TEST PROCEDURE.....129

4.3.4 DEVIATION FROM TEST STANDARD.....129

4.3.5 TEST SETUP.....129

4.3.6 TEST RESULTS131

4.4 ELECTRICAL FAST TRANSIENT/BURST IMMUNITY TEST (EFT) (EN IEC 61000-6-2 & EN 62920).....132

4.4.1 TEST SPECIFICATION132

4.4.2 TEST INSTRUMENTS.....132

4.4.3 TEST PROCEDURE.....133

4.4.4 DEVIATION FROM TEST STANDARD.....133

4.4.5 TEST SETUP.....133

4.4.6 TEST RESULTS135

4.5 SURGE IMMUNITY TEST (EN IEC 61000-6-2 & EN 62920).....139

4.5.1 TEST SPECIFICATION139

4.5.2 TEST INSTRUMENTS.....139

4.5.3 TEST PROCEDURE.....140

4.5.4 DEVIATION FROM TEST STANDARD.....140

4.5.5 TEST SETUP.....141

4.5.6 TEST RESULTS143



4.6	IMMUNITY TO CONDUCTED DISTURBANCES INDUCED BY RF	149
	FIELDS (CS) (EN IEC 61000-6-2 & EN 62920)	149
4.6.1	TEST SPECIFICATION	149
4.6.2	TEST INSTRUMENTS	149
4.6.3	TEST PROCEDURE	150
4.6.4	DEVIATION FROM TEST STANDARD	151
4.6.5	TEST SETUP	151
4.6.6	TEST RESULTS	152
4.7	POWER FREQUENCY MAGNETIC FIELD IMMUNITY TEST (EN IEC 61000-6-2)	154
4.7.1	TEST SPECIFICATION	154
4.7.2	TEST INSTRUMENTS	154
4.7.3	TEST PROCEDURE	154
4.7.4	DEVIATION FROM TEST STANDARD	154
4.7.5	TEST SETUP	155
4.7.6	TEST RESULTS	156
4.8	VOLTAGE DIP/SHORT INTERRUPTIONS/VOLTAGE VARIATIONS (DIP) IMMUNITY TEST (EN62920)	157
4.8.1	TEST SPECIFICATION	157
4.8.2	TEST INSTRUMENTS	157
4.8.3	TEST PROCEDURE	157
4.8.4	DEVIATION FROM TEST STANDARD	157
4.8.5	TEST SETUP	158
4.8.6	TEST RESULTS	159
5	PHOTOGRAPHS OF THE TEST CONFIGURATION	160
6	APPENDIX A – MODIFICATIONS RECORDERS FOR ENGINEERING CHANGES TO THE EUT BY THE LAB	173



RELEASE CONTROL RECORD

ISSUE NO.	REASON FOR CHANGE	DATE ISSUED
CE190827N057	Original release	Aug. 30, 2019
CE2011WDG0014	Based on the original report CE190827N057 update model SUN2000-100KTL-M1 function, additional new code 01074695-009 and AFCI function and PID repair function. Based on the above changes it to be retest all item tests (without harmonics and flicker) after engineer evaluated.	Nov. 04, 2020
CE2201WDG0039	Based on the original report CE2011WDG0014 additional model SUN2000-75KTL-M1 and changed DC switch and update standard versions. but it doesn't need to be retest after engineer evaluated.	Feb. 17, 2022
CE2209WDG0170	Based on the original report CE2201WDG0039 additional models SUN2000-115KTL-M2 and SUN2000-100KTL-M2, The differences are as follows: 1. Change BST IGBT module. 2. Change heat sink, Heat sink tooth pitch encryption. 3. Change the PV cable to a high-temperature cable. 4. Power board PCB IGBT crimping hole changed from 1mm to 1.04mm. 5. Add 9 pcs of 10nF capacitance to the AC port and remove 3 pcs of 470 pF Y capacitance. Based on the above changes it to be retest all item tests (without RS and Dips) after engineer evaluated.	Oct. 08, 2022
CE2302WDG0231	Based on the original report CE2209WDG0170 update standard versions, but it doesn't need to be retest after engineer evaluated.	Mar. 10, 2023
CE2311WDG0110	Based on the original report CE2302WDG0231 additional model SUN2000-110KTL-M2, but it doesn't need to be retest after engineer evaluated	Nov. 27, 2023
CE2312WDG0186	Based on the original report CE2311WDG0110 additional standards EN IEC 61000-6-1:2019 and IEC 61000-6-1:2016 and changed PVEMI PCB board, Based on the above changes it to be retest conducted emission (mains port), radiated emission and surge item tests after engineer evaluated.	Jan. 05, 2024



1 SUMMARY OF TEST RESULTS

The EUT has been tested according to the following specifications:

EMISSION			
Standard	Test Type	Result	Remarks
EN 55011:2016 + A2:2021 (Group 1)	Conducted Test (DC Main Port)	PASS	Meets Requirement Limit Minimum passing margin is 9.38dB at 0.163501MHz
CISPR11:2015+AMD1:2016+ AMD2:2019 (Group 1)	Conducted Test (AC Main Port)	PASS	Meets Requirement Limit Minimum passing margin is 7.32dB at 0.150010MHz
EN 62920:2017+A11:2020 EN 62920:2017+A1:2021 IEC 62920:2017+AMD1:2021	Radiated Test (30MHz~1GHz)	PASS	Meets Limits Minimum passing margin is 4.6dB at 45.965MHz
EN IEC 61000-6-3:2021 (Telecom port)* IEC 61000-6-3:2020 (Telecom port)* EN 62920:2017+A11:2020 EN 62920:2017+A1:2021 IEC 62920:2017+AMD1:2021	Conducted Test (Telecom port)	PASS	Meets Requirement Limit Minimum passing margin is 3.6dB at 0.572999MHz
EN IEC 61000-6-4:2019 (Telecom port) IEC 61000-6-4:2018 (Telecom port) EN 62920:2017+A11:2020 EN 62920:2017+A1:2021 IEC 62920:2017+AMD1:2021	Conducted Test (Telecom port)	PASS	Meets Requirement Limit Minimum passing margin is 17.9dB at 0.429000MHz
EN 61000-3-12:2011 IEC 61000-3-12:2011	Harmonic current emissions	PASS	Meets the requirements.
EN IEC 61000-3-11:2019 IEC 61000-3-11:2017	Voltage fluctuations & flicker	PASS	Meets the requirements.

Remark: * The MBUS communication mode or AC 480V power supply mode of Solar Inverter is not apply to this standard.



IMMUNITY (EN IEC 61000-6-1:2019, IEC 61000-6-1:2016; EN IEC 61000-6-2:2019, IEC 61000-6-2:2016;)			
Standard	Test Type	Result	Remarks
IEC 61000-4-2:2008 ED. 2.0	Electrostatic discharge immunity test	PASS	Electrostatic Discharge – ESD: 8kV Air discharge, 4kV Contact discharge, Performance Criterion A
IEC 61000-4-3:2020 ED. 4.0	Radiated, radio-frequency, electromagnetic field immunity test	PASS	Radio-Frequency Electromagnetic Field Susceptibility Test – RS: 80-1000 MHz, 10V/m, 80% AM (1kHz), 1400-6000 MHz, 10V/m, 80% AM (1kHz) Performance Criterion A
IEC 61000-4-4:2012 ED. 3.0	Electrical fast transient / burst immunity test.	PASS	Electrical Fast Transient/Burst - EFT AC Power line: 2kV, DC Power line: 2kV, Signal line: 1kV Performance Criterion A
IEC 61000-4-5:2017 ED. 3.1	Surge immunity test	PASS	Surge Immunity Test: 1.2/50 us Open Circuit Voltage, 8 /20 us Short Circuit Current, AC Power Line: line to line 1 kV, line to earth 2kV , DC Power Line: line to line 0.5 kV line to earth 0.5kV Signal Line: 1kV Performance Criterion A
IEC 61000-4-6:2013 ED. 4.0	Immunity to conducted disturbances, induced by radio-frequency fields	PASS	Conducted Radio Frequency Disturbances Test – CS: 0.15-80 MHz, 10Vrms, 80% AM, 1kHz, Performance Criterion A
IEC 61000-4-8:2009 ED. 2.0	Power frequency magnetic field immunity test.	PASS	Power Frequency Magnetic Field Test, 50 Hz , 30A/m, Performance Criterion A

Remark: The Immunity Requirements Of IEC 61000-6-2:2016, EN IEC 61000-6-2:2019 Are Stricter Than That Of IEC 61000-6-1:2016, EN IEC 61000-6-1:2019 Respectively, So The EMS Tests Were Performed According To IEC 61000-6-2:2016, EN IEC 61000-6-2:2019.



IMMUNITY (EN 62920:2017+A11:2020, EN 62920:2017+A1:2021, IEC 62920:2017+AMD1:2021)			
Standard	Test Type	Result	Remarks
IEC 61000-4-2:2008 ED. 2.0	Electrostatic discharge immunity test	PASS	Electrostatic Discharge – ESD: 8kV Air discharge, 6kV Contact discharge, Performance Criterion A
IEC 61000-4-3:2020 ED. 4.0	Radiated, radio-frequency, electromagnetic field immunity test	PASS	Radio-Frequency Electromagnetic Field Susceptibility Test – RS: 80-1000 MHz, 10V/m, 80% AM (1kHz), 1400-6000 MHz, 3V/m, 80% AM (1kHz) Performance Criterion A
IEC 61000-4-4:2012 ED. 3.0	Electrical fast transient / burst immunity test.	PASS	Electrical Fast Transient/Burst - EFT AC Power line: 2kV, DC Power line: 2kV, Signal line: 1kV Performance Criterion A
IEC 61000-4-5:2017 ED. 3.1	Surge immunity test	PASS	Surge Immunity Test: 1.2/50 us Open Circuit Voltage, 8 /20 us Short Circuit Current, AC Power Line: line to line 1 kV, line to earth 2kV , DC Power Line: line to line 1 kV line to earth 2kV Signal Line: 1kV, 2kV Performance Criterion A
IEC 61000-4-6:2013 ED. 4.0	Immunity to conducted disturbances, induced by radio-frequency fields	PASS	Conducted Radio Frequency Disturbances Test – CS: 0.15-80 MHz, 10Vrms, 80% AM, 1kHz, Performance Criterion A
IEC 61000-4-34:2009 ED. 1.1	Voltage dips, short interruptions and voltage variations immunity tests	PASS	Meets the requirements of Voltage dips and interruption: 0% U_T – 0.5 period, Performance Criterion A 40% U_T – 10 period, Performance Criterion A 70% U_T – 25 period, B Voltage Interruptions: 0% residual – Performance Criterion B



1.1 MEASUREMENT UNCERTAINTY

Where relevant, the following measurement uncertainty levels have been estimated for tests performed on the EUT as specified in CISPR 16-4-2:

This uncertainty represents an expanded uncertainty expressed at approximately the 95% confidence level using a coverage factor of $k=2$.

MEASUREMENT	FREQUENCY	UNCERTAINTY
Conducted emissions at AC Main Port (Shanghai Huawei)	0.15MHz ~ 30MHz	+ /-2.20 dB
Conducted emissions at DC Power Port (Shanghai Huawei)	0.15MHz ~ 30MHz	+ /-3.70 dB
Conducted Test at Telecom port (Shanghai Huawei)	0.15MHz ~ 30MHz	+ /-2.40 dB
Radiated emissions(Shanghai Huawei)	30MHz ~ 1000MHz	+ /-5.60 dB



2 GENERAL INFORMATION

2.1 GENERAL DESCRIPTION OF EUT

PRODUCT	SOLAR INVERTER
MODEL NO.	SUN2000-100KTL-M1, SUN2000-115KTL-M2
ADDITIONAL MODEL	SUN2000-100KTL-INM0, SUN2000-75KTL-M1, SUN2000-100KTL-M2, SUN2000-110KTL-M2
POWER SUPPLY	<p>SUN2000-115KTL-M2: Input: DC 200-1000V, 30A*10 Output: 230Vac/400Vac, 3(N)W+PE 277Vac/480Vac ; 3W+PE, 50/60Hz, 115kW</p> <p>SUN2000-100KTL-M1: Input: DC 200-1000V, 26A*10 Output: 220Vac/380Vac, 230Vac/400Vac, 3(N)W+PE 277Vac/480Vac ; 3W+PE, 50/60Hz, 100kW</p> <p>SUN2000-110KTL-M2: Input: DC 200-1000V, 30A*10 Output: 380Vac/400Vac, 3W+(N)+PE 50/60Hz, 110kW</p> <p>SUN2000-100KTL-M2: Input: DC 200-1000V, 30A*10 Output: 220Vac/380Vac, 230Vac/400Vac, 3(N)W+PE 277Vac/480Vac ; 3W+PE, 50/60Hz, 100kW</p> <p>SUN2000-75KTL-M1: Input: DC 200-1000V, 26A*10 Output: 220Vac/380Vac, 230Vac/400Vac, 3(N)W+PE 277Vac/480Vac; 3W+PE, 50/60Hz, 75kW</p> <p>SUN2000-100KTL-INM0: Input: DC 200-1000V, 26A*10 Output: 240Vac/415Vac, 3(N)W+PE 277Vac/480Vac ; 3W+PE, 50/60Hz, 100kW</p>
SOFTWARE VERSION	V500R001 (Other Model) V500R023 (SUN2000-115KTL-M2, SUN2000-100KTL-M2)
HARDWARE VERSION	V500R001 (Other Model) V500R023 (SUN2000-115KTL-M2, SUN2000-100KTL-M2)
THE HIGHEST OPERATING FREQUENCY	Below 108MHz
DATA CABLE SUPPLIED	N/A

NOTE:

Bureau Veritas Shenzhen Co., Ltd.
Dongguan Branch

No. 96, Guantai Road (Houjie Section), Houjie
Town, Dongguan City, Guangdong Province.
523942. People's Republic of China

Tel: +86 769 8998 2098
Fax: +86 769 8593 1080
Email: customerservice.dg@bureauveritas.com



1. For the test results, the EUT had been tested with all conditions. But only the worst case was showed in test report.
2. For a more detailed features description, please refer to the manufacturer’s specifications or the User’s Manual.
3. Additional models SUN2000-100KTL-INM0, SUN2000-75KTL-M1, SUN2000-100KTL-M2, SUN2000-110KTL-M2 are identical with the test model SUN2000-100KTL-M1, SUN2000-115KTL-M2, except model number and output voltage and output power and IGBT module and AC port Y capacitance for marketing purpose. the difference has been considered during this test, models SUN2000-100KTL-M1 and SUN2000-115KTL-M2 are selected to test for representative of the maximum output Power, Voltage and Current. The model SUN2000-100KTL-M1 by full tests and SUN2000-115KTL-M2 by partial tests.
4. Please refer to the EUT photo document (Reference No.:2311WDG0110) for detailed product photo.
5. Model List:

Model	Parameter			
	Input	Rated Output	Max	Max. Power
SUN2000-115 KTL-M2	DC 200-1000V, 30A*10 128700W	230Vac/400Vac, 3(N)W+PE 277Vac/480Vac; 3W+PE, 50/60Hz, 115kW	182.3A for 400Vac, 151.9A for 480Vac, 125kVA	125kW
SUN2000-100 KTL-M1	DC 200-1000V, 26A*10 112200W	220Vac/380Vac, 230Vac/400Vac, 3(N)W+PE 277Vac/480Vac ; 3W+PE, 50/60Hz, 100kW	168.8A for 380Vac, 160.4A for 400Vac, 133.7A for 480Vac, 110kVA	110kW
SUN2000-75 KTL-M1	DC 200-1000V, 26A*10 76500W	220Vac/380Vac, 230Vac/400Vac, 3(N)W+PE, 277Vac/480Vac; 3W+PE, 50/60Hz, 75kW	113.6A for 380Vac / 108.6A for 400Vac/ 90.25 for 480Vac 75kVA	75kW
SUN2000-100 KTL-INM0	DC 200-1000V, 26A*10 112200W	240Vac/415Vac, 3(N)W+PE 277Vac/480Vac ; 3W+PE, 50/60Hz, 100kW	154.6A for 415Vac, 133.7A for 480Vac, 110kVA	110kW
SUN2000-100 KTL-M2	DC 200-1000V, 30A*10 112200W	220Vac/380Vac, 230Vac/400Vac, 3(N)W+PE 277Vac/480Vac ; 3W+PE, 50/60Hz, 100kW	168.8A for 380Vac, 160.4A for 400Vac, 133.7A for 480Vac, 110kVA	110kW
SUN2000-110 KTL-M2	DC 200-1000V, 30A*10 110000W	380Vac/400Vac, 3W+(N)+PE, 50/60Hz, 110kW	176.4A for 400Vac, 185.7A for 380Vac, 121kVA	110kW

Model	Parameter				
	RS485	MBUS	USB Smart Dongle	AFCI	PID
SUN2000-115KTL-M2	Support	Support	Support	Optional	Optional
SUN2000-100 KTL-M1	Support	Support	Support	Optional	Optional
SUN2000-75KTL-M1	Support	Support	Support	Not support	Not support
SUN2000-100KTL-INM0	Support	Support	Support	Not support	Not support
SUN2000-100KTL-M2	Support	Support	Support	Optional	Optional
SUN2000-110KTL-M2	Support	Support	Support	Optional	Optional



2.2 DESCRIPTION OF TEST MODES

The EUT was tested under the following modes' the final worst mode were marked in boldface and recorded in this report.

- ◆ For Conducted Emission Test (AC Mains)

Test Mode	TEST VOLTAGE	Remark	Model
Grid Mode(Full Load) + RS485 Data Acquisition	DC 800V; AC 400V	Class B	SUN2000-100KTL-M1
Grid Mode(Full Load) + RS485 Data Acquisition	DC 540V; AC 400V		
Grid Mode(Full Load) + RS485 Data Acquisition	DC 600V; AC 400V		
Grid Mode(10% Load) + RS485 Data Acquisition	DC 200V; AC 400V		
Grid Mode(10% Load) + RS485 Data Acquisition	DC 600V; AC 400V		
Grid Mode(10% Load) + RS485 Data Acquisition	DC 1000V; AC 400V		
Standby+ PID ON + RS485 Data Acquisition	DC 0V; AC 400V		
Standby + RS 485	DC 0V; AC 400V		
Grid Mode(Full Load) + RS485 Data Acquisition	DC 600V; AC 480V		
Grid Mode(Full Load) + MBUS Data Acquisition	DC 800V; AC 480V		
Grid Mode(Full Load) + MBUS Data Acquisition	DC 540V; AC 480V		
Grid Mode(Full Load) + MBUS Data Acquisition	DC 600V; AC 480V		
Grid Mode(10% Load) + MBUS Data Acquisition	DC 200V; AC 480V		
Grid Mode(10% Load) + MBUS Data Acquisition	DC 600V; AC 480V		



Grid Mode(10% Load) + MBUS Data Acquisition	DC 1000V; AC 480V		
Grid Mode(Full Load) + MBUS Data Acquisition	DC 800V; AC 480V		
Standby+ PID ON + MBUS Data Acquisition	DC 0V; AC 480V		
Standby + MBUS	DC 0V; AC 480V		
Test Mode	TEST VOLTAGE	Remark	Model
Grid Mode(Full Load) + RS485 Data Acquisition	DC 800V; AC 400V	Class B	SUN2000-115KTL-M2
Grid Mode(Full Load) + RS485 Data Acquisition	DC 540V; AC 400V		
Grid Mode(Full Load) + RS485 Data Acquisition	DC 600V; AC 400V		
Grid Mode(10% Load) + RS485 Data Acquisition	DC 200V; AC 400V		
Grid Mode(10% Load) + RS485 Data Acquisition	DC 600V; AC 400V		
Grid Mode(10% Load) + RS485 Data Acquisition	DC 1000V; AC 400V		
Standby + RS 485	DC 0V; AC 400V		
Grid Mode(Full Load) + RS485 Data Acquisition	DC 850V; AC 480V		
Grid Mode(Full Load) + MBUS Data Acquisition	DC 625V; AC 480V		
Grid Mode(Full Load) + MBUS Data Acquisition	DC 720V; AC 480V		
Grid Mode(Full Load) + MBUS Data Acquisition	DC 850V; AC 480V		
Grid Mode(10% Load) + MBUS Data Acquisition	DC 200V; AC 480V		
Grid Mode(10% Load) + MBUS Data Acquisition	DC 720V; AC 480V		



Grid Mode(10% Load) + MBUS Data Acquisition	DC 1000V; AC 480V		
Standby + MBUS	DC 0V; AC 480V		

◆ For Conducted Emission Test (DC Mains)

Test Mode	TEST VOLTAGE	Remark	Model
Grid Mode(Full Load) + RS485 Data Acquisition	DC 800V; AC 400V	Class B	SUN2000-100KTL-M1
Grid Mode(Full Load) + RS485 Data Acquisition	DC 540V; AC 400V		
Grid Mode(Full Load) + RS485 Data Acquisition	DC 600V; AC 400V		
Grid Mode(10% Load) + RS485 Data Acquisition	DC 200V; AC 400V		
Grid Mode(10% Load) + RS485 Data Acquisition	DC 600V; AC 400V		
Grid Mode(10% Load) + RS485 Data Acquisition	DC 1000V; AC 400V		
Standby+ PID ON + RS485 Data Acquisition	DC 0V; AC 400V		
Grid Mode(Full Load) + RS485 Data Acquisition	DC 600V; AC 480V	Class A	
Grid Mode(Full Load) + MBUS Data Acquisition	DC 800V; AC 480V		
Grid Mode(Full Load) + MBUS Data Acquisition	DC 540V; AC 480V		
Grid Mode(Full Load) + MBUS Data Acquisition	DC 600V; AC 480V		
Grid Mode(10% Load) + MBUS Data Acquisition	DC 200V; AC 480V		
Grid Mode(10% Load) + MBUS Data Acquisition	DC 600V; AC 480V		
Grid Mode(10% Load) + MBUS Data Acquisition	DC 1000V; AC 480V		

Bureau Veritas Shenzhen Co., Ltd.
Dongguan Branch

No. 96, Guantai Road (Houjie Section), Houjie Town, Dongguan City, Guangdong Province. 523942. People's Republic of China

Tel: +86 769 8998 2098
Fax: +86 769 8593 1080
Email: customerservice.dg@bureauveritas.com



**BUREAU
VERITAS**

Test Report No.: CE2312WDG0186

Grid Mode(Full Load) + MBUS Data Acquisition	DC 800V; AC 480V		
Standby+ PID ON + MBUS Data Acquisition	DC 0V; AC 480V		
Test Mode	TEST VOLTAGE	Remark	Model
Grid Mode(Full Load) + RS485 Data Acquisition	DC 800V; AC 400V	Class B	SUN2000-115KTL-M2
Grid Mode(Full Load) + RS485 Data Acquisition	DC 540V; AC 400V		
Grid Mode(Full Load) + RS485 Data Acquisition	DC 600V; AC 400V		
Grid Mode(10% Load) + RS485 Data Acquisition	DC 200V; AC 400V		
Grid Mode(10% Load) + RS485 Data Acquisition	DC 600V; AC 400V		
Grid Mode(10% Load) + RS485 Data Acquisition	DC 1000V; AC 400V		
Standby + RS485 Data	DC 0V; AC 400V		
Grid Mode(Full Load) + RS485 Data Acquisition	DC 850V; AC 480V		
Grid Mode(Full Load) + MBUS Data Acquisition	DC 850V; AC 480V		
Grid Mode(Full Load) + MBUS Data Acquisition	DC 625V; AC 480V		
Grid Mode(Full Load) + MBUS Data Acquisition	DC 720V; AC 480V		
Grid Mode(10% Load) + MBUS Data Acquisition	DC 200V; AC 480V		
Grid Mode(10% Load) + MBUS Data Acquisition	DC 720V; AC 480V		
Grid Mode(10% Load) + MBUS Data Acquisition	DC 1000V; AC 480V		
Standby + MBUS	DC 0V; AC 480V		

**Bureau Veritas Shenzhen Co., Ltd.
Dongguan Branch**

No. 96, Guantai Road (Houjie Section), Houjie Town, Dongguan City, Guangdong Province. 523942. People's Republic of China

Tel: +86 769 8998 2098
Fax: +86 769 8593 1080
Email: customerservice.dg@bureauveritas.com



◆ **Conducted Emissions At Telecom Port Test**

Test Mode	TEST VOLTAGE	Remark	Model
Grid Mode(Full Load) + RS485 Data Acquisition	DC 800V; AC 400V	Class B	SUN2000-100KTL-M1
Grid Mode(Full Load) + RS485 Data Acquisition	DC 540V; AC 400V		
Grid Mode(Full Load) + RS485 Data Acquisition	DC 600V; AC 400V		
Grid Mode(10% Load) + RS485 Data Acquisition	DC 200V; AC 400V		
Grid Mode(10% Load) + RS485 Data Acquisition	DC 600V; AC 400V		
Grid Mode(10% Load) + RS485 Data Acquisition	DC 1000V; AC 400V		
Standby+ PID ON + RS485 Data Acquisition	DC 0V; AC 400V		
Standby + RS 485	DC 0V; AC 800V		
Grid Mode(Full Load) + RS485 Data Acquisition	DC 600V; AC 480V	Class A	



◆ For Radiated Emission Test

Test Mode	TEST VOLTAGE	Remark	Model
Grid Mode(Full Load) + RS485 Data Acquisition	DC 800V; AC 400V	Class B	
Grid Mode(Full Load) + RS485 Data Acquisition	DC 540V; AC 400V		
Grid Mode(Full Load) + RS485 Data Acquisition	DC 600V; AC 400V		
Grid Mode(10% Load) + RS485 Data Acquisition	DC 200V; AC 400V		
Grid Mode(10% Load) + RS485 Data Acquisition	DC 600V; AC 400V		
Grid Mode(10% Load) + RS485 Data Acquisition	DC 1000V; AC 400V		
Standby+ PID ON + RS485 Data Acquisition	DC 0V; AC 400V		
Standby + RS 485	DC 0V; AC 400V		
Grid Mode(Full Load) + RS485 Data Acquisition	DC 600V; AC 480V	Class A	SUN2000-100KTL-M1
Grid Mode(Full Load) + MBUS Data Acquisition	DC 800V; AC 480V		
Grid Mode(Full Load) + MBUS Data Acquisition	DC 540V; AC 480V		
Grid Mode(Full Load) + MBUS Data Acquisition	DC 600V; AC 480V		
Grid Mode(10% Load) + MBUS Data Acquisition	DC 200V; AC 480V		
Grid Mode(10% Load) + MBUS Data Acquisition	DC 600V; AC 480V		
Grid Mode(10% Load) + MBUS Data Acquisition	DC 1000V; AC 480V		
Grid Mode(Full Load) + MBUS Data Acquisition	DC 800V; AC 480V		



Standby+ PID ON + MBUS Data Acquisition	DC 0V; AC 480V			
Standby + MBUS	DC 0V; AC 400V			
Test Mode	TEST VOLTAGE	Remark	Model	
Grid Mode(Full Load) + RS485 Data Acquisition	DC 800V; AC 400V	Class B	SUN2000-115KTL-M2	
Grid Mode(Full Load) + RS485 Data Acquisition	DC 540V; AC 400V			
Grid Mode(Full Load) + RS485 Data Acquisition	DC 600V; AC 400V			
Grid Mode(10% Load) + RS485 Data Acquisition	DC 200V; AC 400V			
Grid Mode(10% Load) + RS485 Data Acquisition	DC 600V; AC 400V			
Grid Mode(10% Load) + RS485 Data Acquisition	DC 1000V; AC 400V			
Standby + RS 485	DC 0V; AC 400V			
Grid Mode(Full Load) + RS485 Data Acquisition	DC 625V; AC 480V			Class A
Grid Mode(Full Load) + MBUS Data Acquisition	DC 850V; AC 480V			
Grid Mode(Full Load) + MBUS Data Acquisition	DC 720V; AC 480V			
Grid Mode(Full Load) + MBUS Data Acquisition	DC 625V; AC 480V			
Grid Mode(10% Load) + MBUS Data Acquisition	DC 200V; AC 480V			
Grid Mode(10% Load) + MBUS Data Acquisition	DC 720V; AC 480V			
Grid Mode(10% Load) + MBUS Data Acquisition	DC 1000V; AC 480V			
Standby + MBUS	DC 0V; AC 400V			



◆ For Flick Test

Test Mode	TEST VOLTAGE	Model
Grid Mode(Full Load) + RS485 Data Acquisition	DC 600V; AC 400V	SUN2000-100KTL-M1
Grid Mode(Full Load) + RS485 Data Acquisition	DC 720V; AC 480V	
Test Mode	TEST VOLTAGE	Model
Grid Mode(Full Load) + RS485 Data Acquisition	DC 600V; AC 400V	SUN2000-115KTL-M2
Grid Mode(50% Load) + RS485 Data Acquisition		
Grid Mode(25% Load) + RS485 Data Acquisition		

◆ For Harmonic Test

Test Mode	TEST VOLTAGE	Model
Grid Mode(Full Load) + RS485 Data Acquisition	DC 600V; AC 400V	SUN2000-100KTL-M1
Grid Mode(10% Load) + RS485 Data Acquisition	DC 600V; AC 400V	
Grid Mode(50% Load) + RS485 Data Acquisition	DC 600V; AC 400V	
Grid Mode(Full Load) + RS485 Data Acquisition	DC 720V; AC 480V	
Grid Mode(10% Load) + RS485 Data Acquisition	DC 720V; AC 480V	
Grid Mode(50% Load) + RS485 Data Acquisition	DC 720V; AC 480V	
Test Mode	TEST VOLTAGE	Model
Grid Mode(Full Load) + RS485 Data Acquisition	DC 600V; AC 400V	SUN2000-115KTL-M2
Grid Mode(25% Load) + RS485 Data Acquisition	DC 600V; AC 400V	



Grid Mode(50% Load) + RS485 Data Acquisition	DC 600V; AC 400V	
---	-------------------------	--

◆ For Immunity Tests

No.	Test Mode	TEST VOLTAGE	Model
A	Grid Mode (5% Load) + RS485 Data Acquisition	DC 600V; AC 400V	SUN2000-100KTL-M1
B	Standby+ PID ON + RS485 Data Acquisition	DC 0V; AC 400V	
C	Grid Mode (5% Load) + MBUS Data Acquisition	DC 600V; AC 480V	
D	Standby+ PID ON + MBUS Data Acquisition	DC 0V; AC 480V	

◆ For Immunity Tests (Without RS and Dips)

No.	Test Mode	TEST VOLTAGE	Model
A	Grid Mode (5% Load) + RS485 Data Acquisition	DC 600V; AC 400V	SUN2000-115KTL-M2
B	Standby + RS485	DC 0V; AC 400V	
C	Grid Mode (5% Load) + MBUS Data Acquisition	DC 600V; AC 480V	
D	Standby + MBUS	DC 0V; AC 480V	

NOTE: Model SUN2000-75KTL-M1 refer to the data of model SUN2000-100KTL-M1.



2.3 GENERAL DESCRIPTION OF APPLIED STANDARDS

The EUT has been tested and complied with the requirements of the following standards:

EN 55011:2016 + A2:2021 (Group 1)
CISPR11:2015 + AMD1:2016 + AMD2:2019 (Group 1)
EN 62920:2017 + A11:2020, EN 62920:2017 + A1:2021
IEC 62920:2017 + AMD1:2021
EN IEC 61000-6-3:2021(Telecom port)*
IEC 61000-6-3:2020(Telecom port)*
EN IEC 61000-6-4:2019 (Telecom port)
IEC 61000-6-4:2018 (Telecom port)
EN 61000-3-12:2011
IEC 61000-3-12:2011
EN IEC 61000-3-11:2019
IEC 61000-3-11:2017
EN IEC 61000-6-1:2019
IEC 61000-6-1:2016
EN IEC 61000-6-2:2019
IEC 61000-6-2:2016
IEC 61000-4-2:2008 ED. 2.0
IEC 61000-4-3:2020 ED. 4.0
IEC 61000-4-4:2012 ED. 3.0
IEC 61000-4-5:2014 ED. 3.0
IEC 61000-4-6:2013 ED. 4.0
IEC 61000-4-8:2009 ED. 2.0
IEC 61000-4-34:2009 ED. 1.1

Notes: All applicable tests have been performed and recorded as per the above standards.

* The MBUS communication mode or AC 480V power supply mode of Solar Inverter is not apply to this standard.



2.4 DESCRIPTION OF SUPPORT UNITS

The EUT has been tested as an dependent unit together with other necessary accessories or support units. The following support units or accessories were used to form a representative test configuration during the tests.

NO.	PRODUCT	BRAND	MODEL NO.	SERIAL NO.	FCC ID
1	Personal Computer	HP	HP8200	4C1345N8L	N/A
2	Smart Logger	HUAWEI	SmartLogger2 000	2102311HJB10 FB000072	N/A
3	Programmable DC Power Supply	KEYSIGHT	N8957APV	DE17102216	N/A
4	Programmable DC Power Supply	KEYSIGHT	N8957APV	DE17072163	N/A
5	Programmable DC Power Supply	KEYSIGHT	N8957APV	DE16161451	N/A
6	Programmable DC Power Supply	KEYSIGHT	N8957APV	DE17122260	N/A
7	Programmable DC Power Supply	KEYSIGHT	N8957APV	DE17072159	N/A
8	Programmable DC Power Supply	KEYSIGHT	N8957APV	DE17082183	N/A
9	Programmable DC Power Supply	KEYSIGHT	N8957APV	DE17072173	N/A
10	Programmable DC Power Supply	KEYSIGHT	N8957APV	DE17072175	N/A
11	Programmable DC Power Supply	KEYSIGHT	N8957APV	DE16391774	N/A
12	Programmable DC Power Supply	KEYSIGHT	N8957APV	DE16081381	N/A
13	Programmable DC Power Supply	KEYSIGHT	N8957APV	DE16151438	N/A
14	Programmable DC Power Supply	KEYSIGHT	N8957APV	DE16321633	N/A

NO.	DESCRIPTION OF THE ABOVE SUPPORT UNITS
1	AC Line: Unshielded, Detachable 1.8m;
2	DC Cable: Unshielded, Detachable 10m; RJ45 Cable: Shielded, Detachable 10m; RS485 Cable: Shielded, Detachable 10m.
3-14	AC Line: Unshielded, Detachable 1.8m; DC Line: Unshielded, Detachable 1.5m

Remarks: Personal Computer, Smart Logger Unit and Programmable DC Power Supply is distal support units.



3 EMISSION TEST

3.1 CONDUCTED EMISSION MEASUREMENT AT MAIN PORT

3.1.1 LIMITS OF CONDUCTED EMISSION MEASUREMENT AT MAIN PORT

Disturbance voltage limits for class A equipment measured on a test site (a.c. mains power port)

Frequency range MHz	Rated power of ≤ 20 kVA		Rated power of > 20 kVA ^a		High power electronic systems and equipment, rated power of > 75 kVA ^b	
	Quasi-peak dB(μV)	Average dB(μV)	Quasi-peak dB(μV)	Average dB(μV)	Quasi-peak dB(μV)	Average dB(μV)
0,15 to 0,50	79	66	100	90	130	120
0,50 to 5	73	60	86	76	125	115
5 to 30	73	60	90	80	115	105
			Decreasing linearly with logarithm of frequency to			
			73	60		

At the transition frequency, the more stringent limit shall apply.

For class A PCE intended to be connected solely to isolated neutral or high impedance earthed (IT) industrial power distribution networks (see IEC 60364-1), the limits for equipment with a rated power > 75 kVA can be applied.

Limits only apply to low voltage AC mains power ports.

Selection of the appropriate set of limits shall be based on the rated AC power stated by the manufacturer.

^a These limits apply to equipment with a rated power > 20 kVA and intended to be connected to a dedicated power transformer or generator, and which is not connected to low voltage (LV) overhead power lines. For PCE not intended to be connected to a user specific power transformer, the limits for ≤ 20 kVA apply. The manufacturer, and/or supplier shall provide information on installation measures that can be used to reduce emissions from the installed PCE. In particular it shall be indicated that this PCE is intended to be connected to a dedicated power transformer or generator and not to LV overhead power lines.

^b These limits apply only to high power electronic systems and equipment with a rated power greater than 75 kVA when intended to be installed as follows:

- installation is supplied from a dedicated power transformer or generator, and which is not connected to LV overhead power lines;
- installation is physically separated from residential environments by distance greater than 30 m or by a structure which acts as a barrier to radiated phenomena;
- the manufacturer and/or supplier shall indicate that this equipment meets the disturbance voltage limits for high power electronic systems and equipment of rated input power > 75 kVA and provide information on installation measures to be applied by the installer. In particular, it shall be indicated that this PCE is intended to be used in an installation which is powered by a dedicated power transformer or generator and not by LV overhead power lines.

NOTE: (1) The lower limit shall apply at the transition frequencies.

**Disturbance voltage limits for class B equipment measured on a test site (a.c. mains power port)**

Frequency range MHz	Quasi-peak dB(μ V)	Average dB(μ V)
0,15 to 0,50	66 Decreasing linearly with logarithm of frequency to 56	56 Decreasing linearly with logarithm of frequency to 46
0,50 to 5	56	46
5 to 30	60	50

At the transition frequency, the more stringent limit shall apply.

Limits for conducted disturbances of class A equipment measured on a test site (d.c. power port)

Frequency range MHz	Rated power of ≤ 20 kVA		Rated power of > 20 kVA to ≤ 75 kVA		Rated power of > 75 kVA	
	Voltage limits		Voltage limits		Voltage limits	
	QP dB(μ V)	AV dB(μ V)	QP dB(μ V)	AV dB(μ V)	QP dB(μ V)	AV dB(μ V)
0,15 to 5	97 to 89	84 to 76	116 to 106	106 to 96	132 to 122	122 to 112
5 to 30	89 to 89	76 to 76	106 to 89	96 to 76	122 to 105	112 to 92

In certain frequency ranges, the limits in this table decrease linearly with logarithm of frequency.
Selection of the appropriate set of limits shall be based on the rated AC power stated by the manufacturer.

Limits for conducted disturbances of class B equipment measured on a test site (d.c. power port)

Frequency range MHz	Quasi-peak dB(μ V)	Average dB(μ V)
0,15 to 0,50	84 Decreasing linearly with logarithm of frequency to 74	74 Decreasing linearly with logarithm of frequency to 64
0,50 to 30	74	64

The limits in this table may be subject to change in the next edition of this document when further experience has been gathered and investigations in modelling are concluded.



3.1.2 TEST INSTRUMENTS

Equipment	Manufacturer	Model No.	Serial No.	Last Cal.	Next Cal.
EMI Test Receiver	Rohde&Schwarz	ESC13	101019	Jun. 03, 2019	Jun. 02, 2020
Artificial Mains Network	Rohde&Schwarz	ENV4200	100141	Feb. 18, 2019	Feb. 17, 2020
DC Artificial Network	SCHWARZBECK	PVDC 8301 RC	8301-RC 01000	Feb. 18, 2019	Feb. 17, 2020
DC Artificial Network	SCHWARZBECK	PVDC 8301	8301-37	Feb. 18, 2019	Feb. 17, 2020
DC Artificial Network	SCHWARZBECK	PVDC 8301	8301-35	Apr. 17, 2019	Apr. 16, 2020

Equipment	Manufacturer	Model No.	Serial No.	Last Cal.	Next Cal.
EMI Test Receiver	Rohde&Schwarz	ESC13	101019	2020/07/03	2021/07/02
Artificial Mains Network	Rohde&Schwarz	ENV4200	100141	2020/02/26	2021/02/25
DC Artificial Network	SCHWARZBECK	PVDC 8301 RC	01000	2020/02/26	2021/02/25
DC Artificial Network	SCHWARZBECK	PVDC 8301	8301-37	2020/08/29	2021/08/28
DC Artificial Network	SCHWARZBECK	PVDC 8301	8301-35	2020/04/10	2021/04/09
100Ω Resistance	LUTHI	100Ω Resistance	370	2020/04/28	2021/04/27
Current probe	FCC	F-52	111659	2020/05/13	2021/05/12

NOTE: 1. The test was performed by witness in conducted shielding room of Shanghai Testing & Inspection Institute for Electrical Equipment

2. The test was performed in Conducted shielding room .

Equipment	Manufacturer	Model No.	Serial No.	Last Cal.	Next Cal.
EMI Test Receiver	Rohde&Schwarz	ESC13	101019	2022/08/10	2023/08/09
Artificial Mains Network	SCHWARZBECK	NNLK8129	5184	2022/08/08	2023/08/07
DC Artificial Network	SCHWARZBECK	PVDC 8301 RC	01000	2021/12/09	2022/12/08
DC Artificial Network	SCHWARZBECK	PVDC 8301	8301-37	2022/08/08	2023/08/07
DC Artificial Network	SCHWARZBECK	PVDC 8301	8301-35	2021/12/09	2022/12/08
100Ω Resistance	LUTHI	100Ω Resistance	370	2021/12/06	2022/12/05
Current probe	FCC	F-52	111659	2022/08/08	2023/08/07

Equipment	Manufacturer	Model No.	Serial No.	Last Cal.	Next Cal.
EMI Test Receiver	Rohde&Schwarz	ESC13	101019	2023/06/29	2024/06/28
Artificial Mains Network	Rohde&Schwarz	ENV4200	100141	2022/10/14	2023/10/13
DC Artificial Network	SCHWARZBECK	PVDC 8301	37	2023/07/03	2024/07/02
DC Artificial Network	SCHWARZBECK	PVDC 8301	01007	2023/07/11	2024/07/10
DC Artificial Network	SCHWARZBECK	PVDC 8301	01000	2022/11/17	2023/11/16
100Ω Resistance	LUTHI	100Ω Resistance	370	2022/11/14	2023/11/13
Current probe	FCC	F-52	111659	2023/06/30	2024/06/29

NOTE: 1. The test was performed by witness in conducted shielding room of Reliability Laboratory of Huawei Technologies Co., Ltd.

2. The test was performed in Conducted shielding room.



3.1.3 TEST PROCEDURE

- a. The EUT was placed 0.4 meters from the conducting wall of the shielded room with EUT being connected to the power mains through a line impedance stabilization network (LISN). Other support units were connected to the power mains through another LISN. The two LISNs provide 50 Ohm/ 50uH of coupling impedance for the measuring instrument.
- b. The artificial network for the assessment of disturbance voltages at d.c. power ports (DC-AN) provides a defined common mode (CM) 150 Ω termination impedance for the d.c. power port of the power converter under test during measurements of conducted RF disturbances at standardized test sites. It is constructed to provide, in the intended frequency range from 150 kHz to 30 MHz, well defined termination impedances for symmetric (or differential mode – DM) as well as asymmetric (or common mode – CM) disturbance components.
- c. Both lines of the power mains connected to the EUT were checked for maximum conducted interference.
- d. The frequency range from 150 kHz to 30 MHz was searched. Emission levels under (Limit – 20dB) were not recorded.

3.1.4 DEVIATION FROM TEST STANDARD

No deviation



3.1.5 TEST SETUP

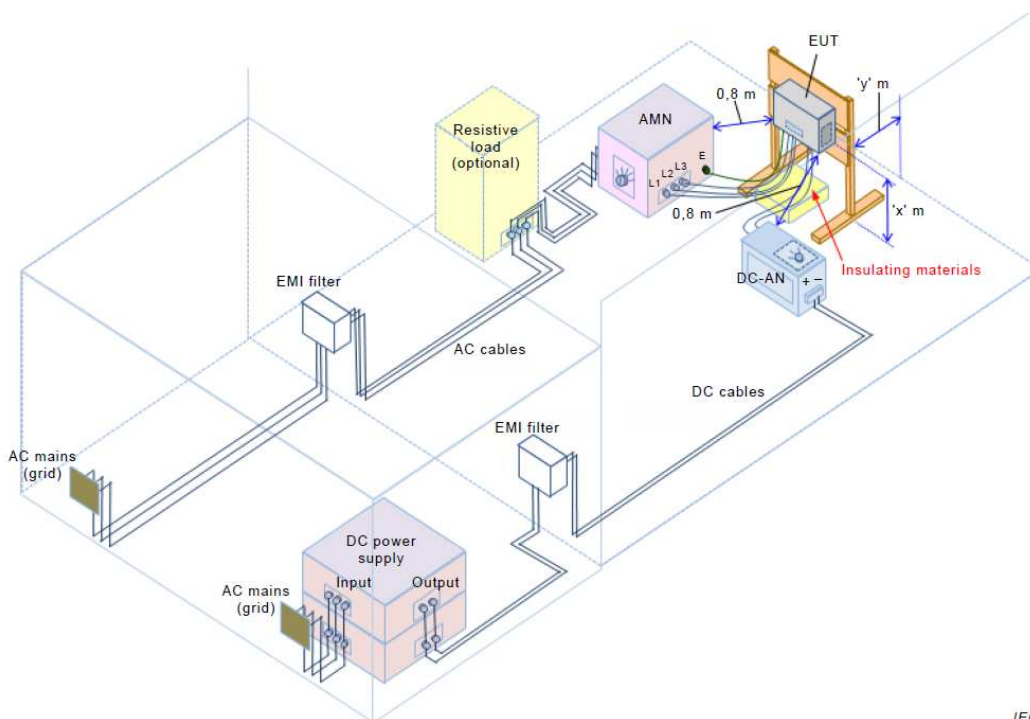

3.1.6 EUT OPERATING CONDITIONS

- a. Turned on the power of all equipment.
- b. EUT was operated according to the type used was description in manufacturer's specifications or the User's Manual.



3.1.7 TEST RESULTS

AC Mains

TEST MODE	SUN2000-100KTL-M1 Grid Mode(Full Load) + RS485 Data Acquisition	6dB BANDWIDTH	9 kHz
TEST VOLTAGE	DC 800V AC 400V	PHASE	Line (L1)
ENVIRONMENTAL CONDITIONS	25 deg. C, 50% RH	TESTED BY: XUEHAIFENG	

Frequency (MHz)	QuasiPeak (dB μ V)	CAverage (dB μ V)	Limit (dB μ V)	Margin (dB)	Meas. Time (ms)	Bandwidth (kHz)	Line	Corr. (dB)
0.150010	---	46.77	56.00	9.23	1000.0	9.000	L1	21.4
0.150010	55.54	---	66.00	10.46	1000.0	9.000	L1	21.4
0.162010	53.98	---	65.31	11.33	1000.0	9.000	L1	21.4
0.162010	---	45.83	55.30	9.47	1000.0	9.000	L1	21.4
0.173510	48.25	---	64.70	16.46	1000.0	9.000	L1	21.4
20.507452	42.18	---	60.00	17.82	1000.0	9.000	L1	21.8
20.756914	43.46	---	60.00	16.54	1000.0	9.000	L1	21.8
20.763300	---	37.71	50.00	12.29	1000.0	9.000	L1	21.8
20.821942	43.58	---	60.00	16.42	1000.0	9.000	L1	21.8
20.843494	---	38.00	50.00	12.00	1000.0	9.000	L1	21.8
20.861947	---	38.00	50.00	12.00	1000.0	9.000	L1	21.8
20.918914	---	38.30	50.00	11.70	1000.0	9.000	L1	21.8

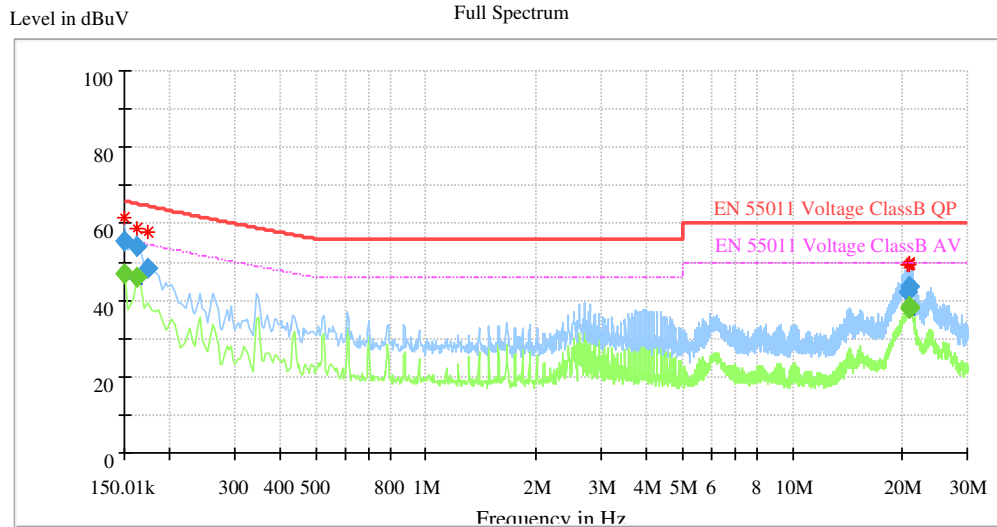



**BUREAU
VERITAS**

Test Report No.: CE2312WDG0186

TEST MODE	SUN2000-100KTL-M1 Grid Mode(Full Load) + RS485 Data Acquisition	6dB BANDWIDTH	9 kHz
TEST VOLTAGE	DC 800V AC 400V	PHASE	Line (L2)
ENVIRONMENTAL CONDITIONS	25 deg. C, 50% RH	TESTED BY: XUEHAIFENG	

Frequency (MHz)	QuasiPeak (dB μ V)	CAverage (dB μ V)	Limit (dB μ V)	Margin (dB)	Meas. Time (ms)	Bandwidth (kHz)	Line	Corr. (dB)
0.150010	---	47.16	56.00	8.84	1000.0	9.000	L2	21.4
0.150010	58.68	---	66.00	7.32	1000.0	9.000	L2	21.4
0.154510	55.85	---	65.73	9.88	1000.0	9.000	L2	21.4
0.157010	54.65	---	65.59	10.94	1000.0	9.000	L2	21.4
0.162010	---	46.53	55.30	8.77	1000.0	9.000	L2	21.4
0.261510	---	35.68	51.14	15.46	1000.0	9.000	L2	21.3
0.267010	45.86	---	61.01	15.15	1000.0	9.000	L2	21.3
0.345510	44.16	---	58.90	14.74	1000.0	9.000	L2	21.3
4.296088	36.70	---	56.00	19.30	1000.0	9.000	L2	21.2
4.300565	---	27.53	46.00	18.47	1000.0	9.000	L2	21.2
4.308508	---	27.29	46.00	18.71	1000.0	9.000	L2	21.2
20.876096	---	37.59	50.00	12.41	1000.0	9.000	L2	21.8

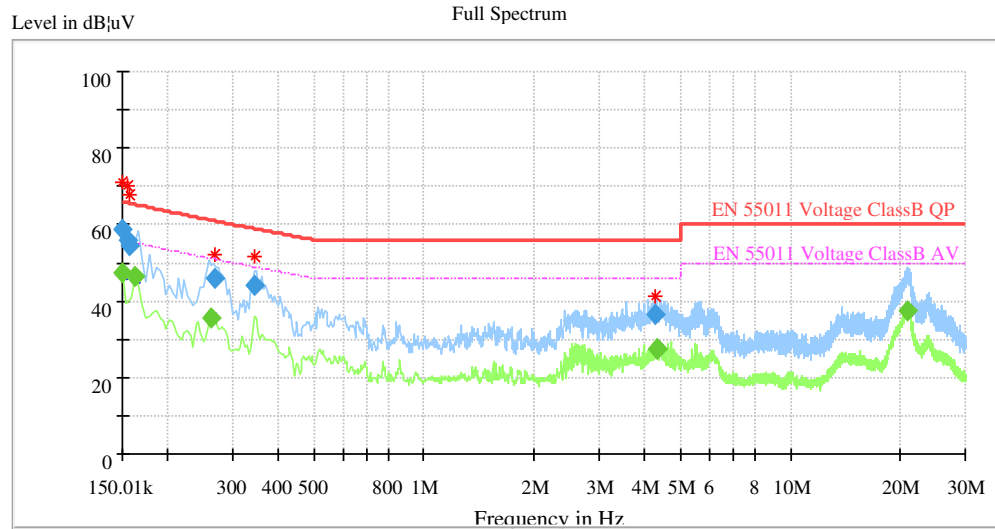

**Bureau Veritas Shenzhen Co., Ltd.
Dongguan Branch**

No. 96, Guantai Road (Houjie Section), Houjie
Town, Dongguan City, Guangdong Province.
523942, People's Republic of China

Tel: +86 769 8998 2098
Fax: +86 769 8593 1080
Email: customerservice.dg@bureauveritas.com



TEST MODE	SUN2000-100KTL-M1 Grid Mode(Full Load) + RS485 Data Acquisition	6dB BANDWIDTH	9 kHz
TEST VOLTAGE	DC 800V AC 400V	PHASE	Line (L3)
ENVIRONMENTAL CONDITIONS	25 deg. C, 50% RH	TESTED BY: XUEHAIFENG	

Frequency (MHz)	QuasiPeak (dB μ V)	CAverage (dB μ V)	Limit (dB μ V)	Margin (dB)	Meas. Time (ms)	Bandwidth (kHz)	Line	Corr. (dB)
0.150010	---	47.25	56.00	8.75	1000.0	9.000	L3	21.4
0.154510	46.89	---	65.73	18.84	1000.0	9.000	L3	21.4
0.157510	48.41	---	65.56	17.15	1000.0	9.000	L3	21.4
0.162010	---	46.22	55.30	9.08	1000.0	9.000	L3	21.4
0.261510	---	32.06	51.14	19.08	1000.0	9.000	L3	21.3
0.270510	33.94	---	60.90	26.96	1000.0	9.000	L3	21.3
0.346010	39.15	---	58.89	19.74	1000.0	9.000	L3	21.2
4.300003	---	27.79	46.00	18.21	1000.0	9.000	L3	21.2
4.363904	35.93	---	56.00	20.07	1000.0	9.000	L3	21.2
20.691455	42.79	---	60.00	17.21	1000.0	9.000	L3	21.8
20.713010	---	37.34	50.00	12.66	1000.0	9.000	L3	21.8
20.856276	---	37.58	50.00	12.42	1000.0	9.000	L3	21.8

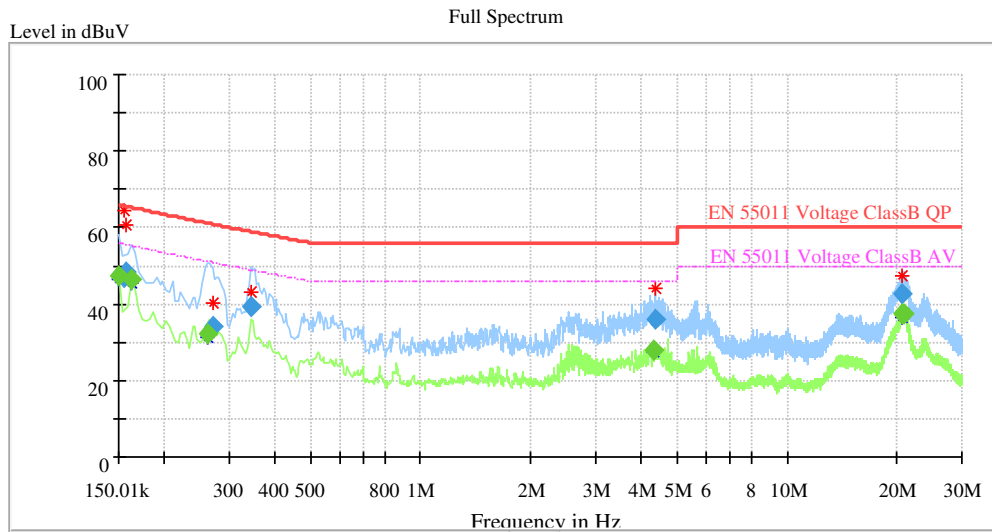



**BUREAU
VERITAS**

Test Report No.: CE2312WDG0186

TEST MODE	SUN2000-100KTL-M1 Grid Mode(Full Load) + RS485 Data Acquisition	6dB BANDWIDTH	9 kHz
TEST VOLTAGE	DC 800V AC 400V	PHASE	NEUTRAL (N)
ENVIRONMENTAL CONDITIONS	25 deg. C, 50% RH	TESTED BY: XUEHAIFENG	

Frequency (MHz)	QuasiPeak (dB μ V)	CAverage (dB μ V)	Limit (dB μ V)	Margin (dB)	Meas. Time (ms)	Bandwidth (kHz)	Line	Corr. (dB)
0.517510	---	32.40	46.00	13.60	1000.0	9.000	N	21.2
0.525009	---	30.76	46.00	15.24	1000.0	9.000	N	21.2
0.526510	40.20	---	56.00	15.80	1000.0	9.000	N	21.2
0.529510	39.87	---	56.00	16.13	1000.0	9.000	N	21.2
0.610010	39.91	---	56.00	16.09	1000.0	9.000	N	21.2
0.858010	---	31.00	46.00	15.00	1000.0	9.000	N	21.3
12.765368	36.01	---	60.00	23.99	1000.0	9.000	N	21.3
13.047119	---	30.02	50.00	19.98	1000.0	9.000	N	21.3
13.072658	38.38	---	60.00	21.62	1000.0	9.000	N	21.3
13.110006	36.52	---	60.00	23.48	1000.0	9.000	N	21.3
13.135771	---	29.51	50.00	20.49	1000.0	9.000	N	21.3
27.316892	---	21.98	50.00	28.02	1000.0	9.000	N	21.6

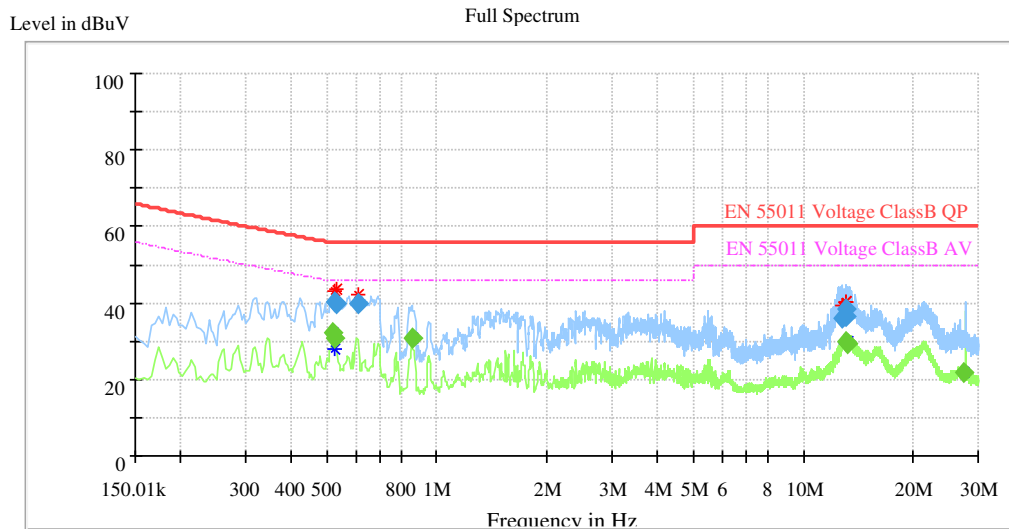

Bureau Veritas Shenzhen Co., Ltd.
Dongguan Branch

No. 96, Guantai Road (Houjie Section), Houjie
Town, Dongguan City, Guangdong Province.
523942. People's Republic of China

Tel: +86 769 8998 2098
Fax: +86 769 8593 1080
Email: customerservice.dg@bureauveritas.com



TEST MODE	SUN2000-100KTL-M1 Grid Mode(Full Load) + RS485 Data Acquisition	6dB BANDWIDTH	9 kHz
TEST VOLTAGE	DC 800V AC 480V	PHASE	Line (L1)
ENVIRONMENTAL CONDITIONS	25 deg. C, 50% RH	TESTED BY: Wang Jia	

Frequency (MHz)	QuasiPeak (dB μ V)	Meas. Time (ms)	Bandwidth (kHz)	PE	Line	Corr. (dB)	Margin (dB)	Limit (dB μ V)	Comment
0.150000	59.6	1000.0	9.000	GND	L1	11.3	70.4	130.0	
5.970248	40.1	1000.0	9.000	GND	L1	11.3	74.9	115.0	
6.028478	40.6	1000.0	9.000	GND	L1	11.3	74.4	115.0	
6.185032	40.3	1000.0	9.000	GND	L1	11.3	74.7	115.0	
6.279060	39.9	1000.0	9.000	GND	L1	11.3	75.1	115.0	
6.332812	39.9	1000.0	9.000	GND	L1	11.3	75.1	115.0	
Frequency (MHz)	Average (dB μ V)	Meas. Time (ms)	Bandwidth (kHz)	PE	Line	Corr. (dB)	Margin (dB)	Limit (dB μ V)	Comment
5.428222	34.1	1000.0	9.000	GND	L1	11.3	70.9	105.0	
5.929748	34.4	1000.0	9.000	GND	L1	11.3	70.6	105.0	
5.983478	34.3	1000.0	9.000	GND	L1	11.3	70.7	105.0	
6.162532	34.4	1000.0	9.000	GND	L1	11.3	70.6	105.0	
6.283560	34.1	1000.0	9.000	GND	L1	11.3	70.9	105.0	
6.346312	33.9	1000.0	9.000	GND	L1	11.3	71.1	105.0	

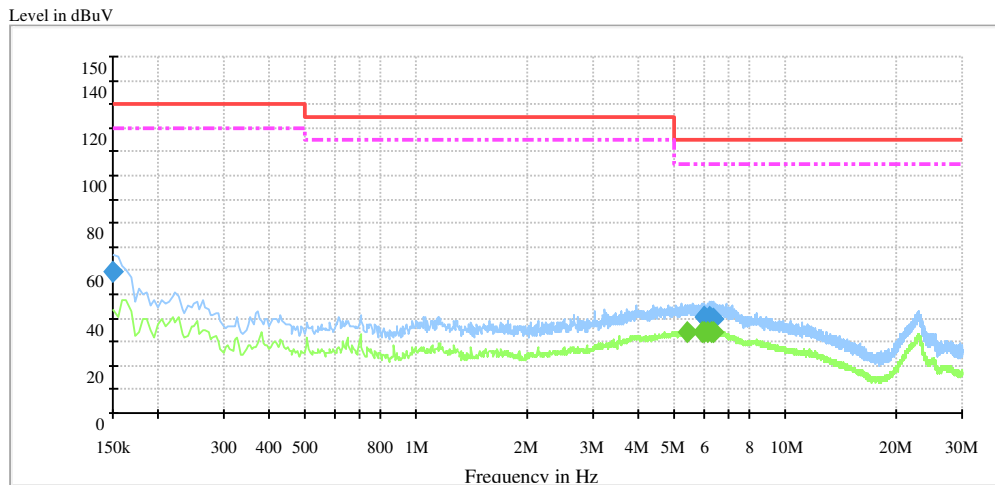



TEST MODE	SUN2000-100KTL-M1 Grid Mode(Full Load) + RS485 Data Acquisition	6dB BANDWIDTH	9 kHz
TEST VOLTAGE	DC 800V AC 480V	PHASE	Line (L2)
ENVIRONMENTAL CONDITIONS	25 deg. C, 50% RH	TESTED BY: Wang Jia	

Frequency (MHz)	QuasiPeak (dB μ V)	Meas. Time (ms)	Bandwidth (kHz)	PE	Line	Corr. (dB)	Margin (dB)	Limit (dB μ V)	Comment
0.154500	59.3	1000.0	9.000	GND	L2	11.2	70.7	130.0	
0.159000	57.2	1000.0	9.000	GND	L2	11.2	72.8	130.0	
0.195000	47.2	1000.0	9.000	GND	L2	11.2	82.8	130.0	
8.414760	36.9	1000.0	9.000	GND	L2	11.3	78.1	115.0	
8.455058	36.8	1000.0	9.000	GND	L2	11.3	78.2	115.0	
8.558078	37.1	1000.0	9.000	GND	L2	11.3	77.9	115.0	
Frequency (MHz)	Average (dB μ V)	Meas. Time (ms)	Bandwidth (kHz)	PE	Line	Corr. (dB)	Margin (dB)	Limit (dB μ V)	Comment
0.163500	49.0	1000.0	9.000	GND	L2	11.2	71.0	120.0	
3.422392	44.0	1000.0	9.000	GND	L2	11.3	71.0	115.0	
3.474788	41.9	1000.0	9.000	GND	L2	11.3	73.1	115.0	
3.529762	45.1	1000.0	9.000	GND	L2	11.3	69.9	115.0	
3.565582	43.1	1000.0	9.000	GND	L2	11.3	71.9	115.0	
3.565672	44.5	1000.0	9.000	GND	L2	11.3	70.5	115.0	

Level in dBuV

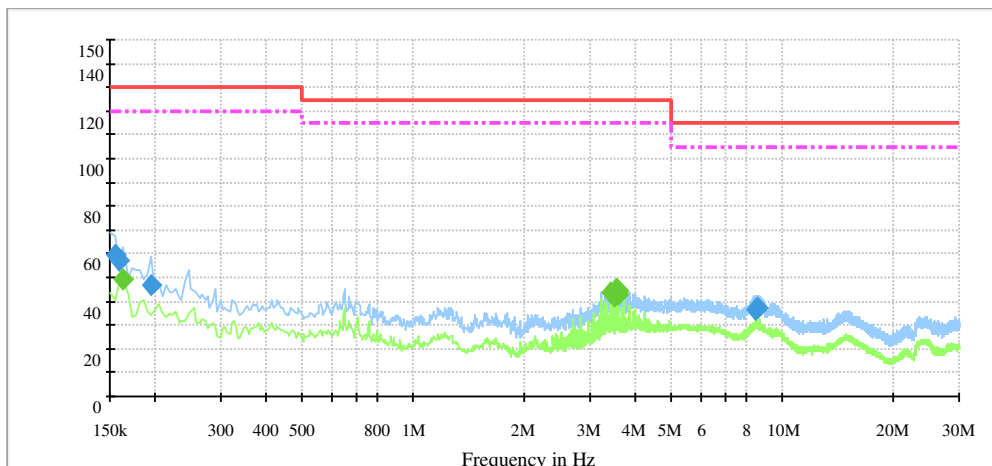



TEST MODE	SUN2000-100KTL-M1 Grid Mode(Full Load) + RS485 Data Acquisition	6dB BANDWIDTH	9 kHz
TEST VOLTAGE	DC 800V AC 480V	PHASE	Line (L3)
ENVIRONMENTAL CONDITIONS	25 deg. C, 50% RH	TESTED BY: Wang Jia	

Frequency (MHz)	QuasiPeak (dB μ V)	Meas. Time (ms)	Bandwidth (kHz)	PE	Line	Corr. (dB)	Margin (dB)	Limit (dB μ V)	Comment
5.374650	59.8	1000.0	9.000	GND	L3	31.4	55.2	115.0	
6.216285	60.2	1000.0	9.000	GND	L3	31.4	54.8	115.0	
6.351098	60.0	1000.0	9.000	GND	L3	31.4	55.0	115.0	
6.399998	59.7	1000.0	9.000	GND	L3	31.4	55.3	115.0	
6.610462	59.9	1000.0	9.000	GND	L3	31.4	55.1	115.0	
6.744652	59.6	1000.0	9.000	GND	L3	31.4	55.4	115.0	
Frequency (MHz)	Average (dB μ V)	Meas. Time (ms)	Bandwidth (kHz)	PE	Line	Corr. (dB)	Margin (dB)	Limit (dB μ V)	Comment
5.396850	53.8	1000.0	9.000	GND	L3	31.4	51.2	105.0	
6.050752	54.6	1000.0	9.000	GND	L3	31.4	50.4	105.0	
6.274215	54.1	1000.0	9.000	GND	L3	31.4	50.9	105.0	
6.328402	54.1	1000.0	9.000	GND	L3	31.4	50.9	105.0	
6.386498	53.9	1000.0	9.000	GND	L3	31.4	51.1	105.0	
6.605962	53.7	1000.0	9.000	GND	L3	31.4	51.3	105.0	

Level in dBuV

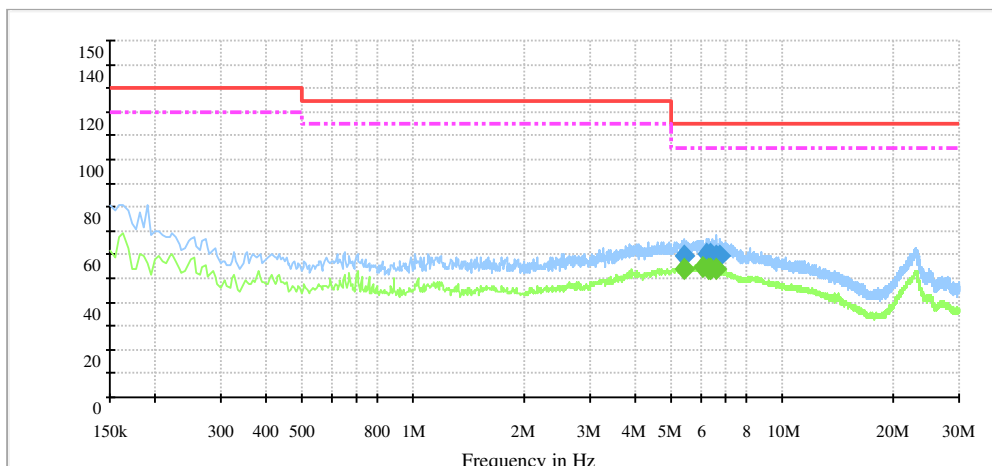



TEST MODE	SUN2000-100KTL-M1 Grid Mode(Full Load) + MBUS Data Acquisition	6dB BANDWIDTH	9 kHz
TEST VOLTAGE	DC 800V AC 480V	PHASE	Line (L1)
ENVIRONMENTAL CONDITIONS	25 deg. C, 50% RH	TESTED BY: Wang Jia	

Frequency (MHz)	QuasiPeak (dB μ V)	Meas. Time (ms)	Bandwidth (kHz)	PE	Line	Corr. (dB)	Margin (dB)	Limit (dB μ V)	Comment
5.007360	83.1	1000.0	9.000	GND	L1	31.3	31.9	115.0	
5.034450	80.7	1000.0	9.000	GND	L1	31.3	34.3	115.0	
5.088000	80.4	1000.0	9.000	GND	L1	31.3	34.6	115.0	
5.321010	84.2	1000.0	9.000	GND	L1	31.3	30.8	115.0	
5.593912	82.7	1000.0	9.000	GND	L1	31.3	32.3	115.0	
5.593958	81.6	1000.0	9.000	GND	L1	31.3	33.4	115.0	
Frequency (MHz)	Average (dB μ V)	Meas. Time (ms)	Bandwidth (kHz)	PE	Line	Corr. (dB)	Margin (dB)	Limit (dB μ V)	Comment
5.056838	61.9	1000.0	9.000	GND	L1	31.3	43.1	105.0	
5.125500	63.1	1000.0	9.000	GND	L1	31.3	41.9	105.0	
5.321010	58.5	1000.0	9.000	GND	L1	31.3	46.5	105.0	
5.490908	59.7	1000.0	9.000	GND	L1	31.3	45.3	105.0	
5.531452	54.6	1000.0	9.000	GND	L1	31.3	50.4	105.0	
5.584958	60.3	1000.0	9.000	GND	L1	31.3	44.7	105.0	

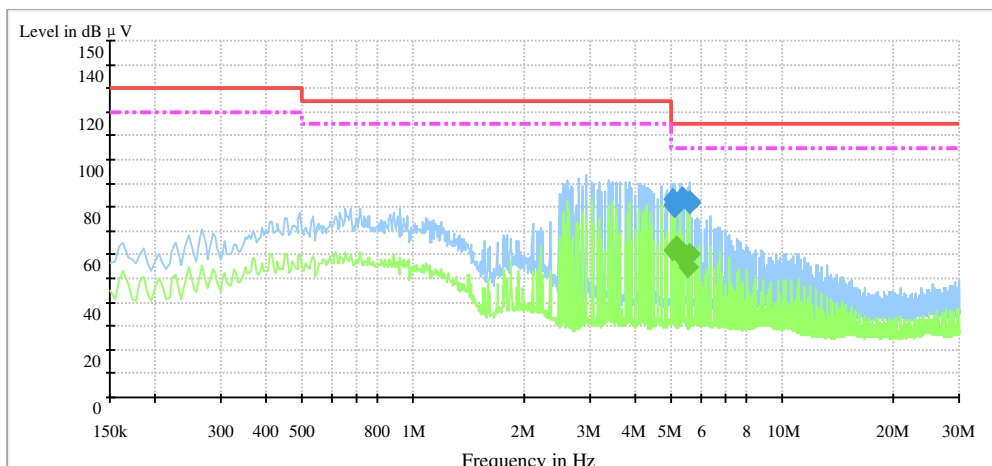



TEST MODE	SUN2000-100KTL-M1 Grid Mode(Full Load) + MBUS Data Acquisition	6dB BANDWIDTH	9 kHz
TEST VOLTAGE	DC 800V AC 480V	PHASE	Line (L2)
ENVIRONMENTAL CONDITIONS	25 deg. C, 50% RH	TESTED BY: Wang Jia	

Frequency (MHz)	QuasiPeak (dB μ V)	Meas. Time (ms)	Bandwidth (kHz)	PE	Line	Corr. (dB)	Margin (dB)	Limit (dB μ V)	Comment
5.025338	83.6	1000.0	9.000	GND	L2	31.3	31.4	115.0	
5.029770	85.7	1000.0	9.000	GND	L2	31.3	29.3	115.0	
5.132842	84.8	1000.0	9.000	GND	L2	31.3	30.2	115.0	
5.146388	83.8	1000.0	9.000	GND	L2	31.3	31.2	115.0	
5.397015	86.8	1000.0	9.000	GND	L2	31.3	28.2	115.0	
5.540295	85.5	1000.0	9.000	GND	L2	31.3	29.5	115.0	
Frequency (MHz)	Average (dB μ V)	Meas. Time (ms)	Bandwidth (kHz)	PE	Line	Corr. (dB)	Margin (dB)	Limit (dB μ V)	Comment
3.185018	63.1	1000.0	9.000	GND	L2	31.3	51.9	115.0	
3.492878	67.4	1000.0	9.000	GND	L2	31.3	47.6	115.0	
5.084798	60.0	1000.0	9.000	GND	L2	31.3	45.0	105.0	
5.105888	64.5	1000.0	9.000	GND	L2	31.3	40.5	105.0	
5.388015	61.9	1000.0	9.000	GND	L2	31.3	43.1	105.0	
5.508818	61.3	1000.0	9.000	GND	L2	31.3	43.7	105.0	

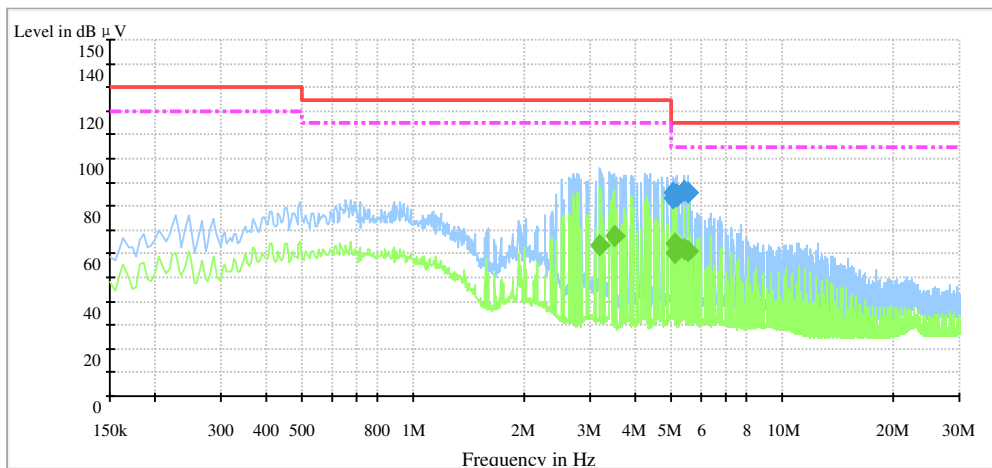



TEST MODE	SUN2000-100KTL-M1 Grid Mode(Full Load) + MBUS Data Acquisition	6dB BANDWIDTH	9 kHz
TEST VOLTAGE	DC 800V AC 480V	PHASE	Line (L3)
ENVIRONMENTAL CONDITIONS	25 deg. C, 50% RH	TESTED BY: Wang Jia	

Frequency (MHz)	QuasiPeak (dB μ V)	Meas. Time (ms)	Bandwidth (kHz)	PE	Line	Corr. (dB)	Margin (dB)	Limit (dB μ V)	Comment
5.074612	90.8	1000.0	9.000	GND	L3	31.4	24.2	115.0	
5.262758	86.2	1000.0	9.000	GND	L3	31.4	28.8	115.0	
5.316510	90.0	1000.0	9.000	GND	L3	31.4	25.0	115.0	
5.370240	92.1	1000.0	9.000	GND	L3	31.4	22.9	115.0	
5.441880	91.0	1000.0	9.000	GND	L3	31.4	24.0	115.0	
5.513542	89.1	1000.0	9.000	GND	L3	31.4	25.9	115.0	
Frequency (MHz)	Average (dB μ V)	Meas. Time (ms)	Bandwidth (kHz)	PE	Line	Corr. (dB)	Margin (dB)	Limit (dB μ V)	Comment
3.283635	66.1	1000.0	9.000	GND	L3	31.3	48.9	115.0	
4.537402	68.6	1000.0	9.000	GND	L3	31.3	46.4	115.0	
5.074612	70.4	1000.0	9.000	GND	L3	31.4	34.6	105.0	
5.419380	70.2	1000.0	9.000	GND	L3	31.4	34.8	105.0	
5.446312	67.2	1000.0	9.000	GND	L3	31.4	37.8	105.0	
5.468520	67.6	1000.0	9.000	GND	L3	31.4	37.4	105.0	

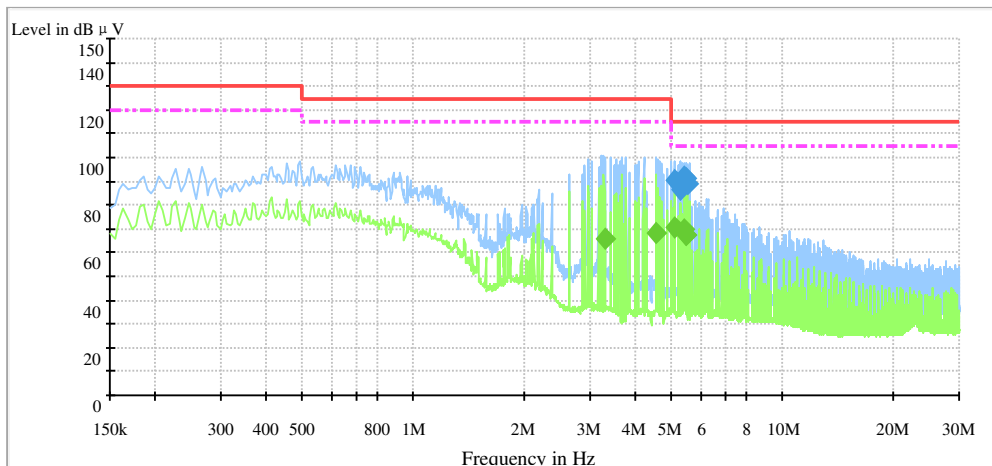



TEST MODE	SUN2000-100KTL-M1 Grid Mode(Full Load) + MBUS Data Acquisition	6dB BANDWIDTH	9 kHz
TEST VOLTAGE	DC 800V AC 480V	PHASE	NEUTRAL (N)
ENVIRONMENTAL CONDITIONS	25 deg. C, 50% RH	TESTED BY: Wang Jia	

Frequency (MHz)	QuasiPeak (dB μ V)	Meas. Time (ms)	Bandwidth (kHz)	PE	Line	Corr. (dB)	Margin (dB)	Limit (dB μ V)	Comment
5.253622	66.8	1000.0	9.000	GND	N	31.3	48.2	115.0	
5.298465	68.9	1000.0	9.000	GND	N	31.3	46.1	115.0	
5.315445	66.3	1000.0	9.000	GND	N	31.3	48.7	115.0	
5.361218	64.9	1000.0	9.000	GND	N	31.3	50.1	115.0	
5.441880	69.3	1000.0	9.000	GND	N	31.3	45.7	115.0	
5.504542	64.5	1000.0	9.000	GND	N	31.3	50.5	115.0	
Frequency (MHz)	Average (dB μ V)	Meas. Time (ms)	Bandwidth (kHz)	PE	Line	Corr. (dB)	Margin (dB)	Limit (dB μ V)	Comment
5.226780	44.9	1000.0	9.000	GND	N	31.3	60.1	105.0	
5.285055	41.1	1000.0	9.000	GND	N	31.3	63.9	105.0	
5.294122	47.7	1000.0	9.000	GND	N	31.3	57.3	105.0	
5.343218	45.7	1000.0	9.000	GND	N	31.3	59.3	105.0	
5.414880	45.2	1000.0	9.000	GND	N	31.3	59.8	105.0	
5.473042	44.8	1000.0	9.000	GND	N	31.3	60.2	105.0	

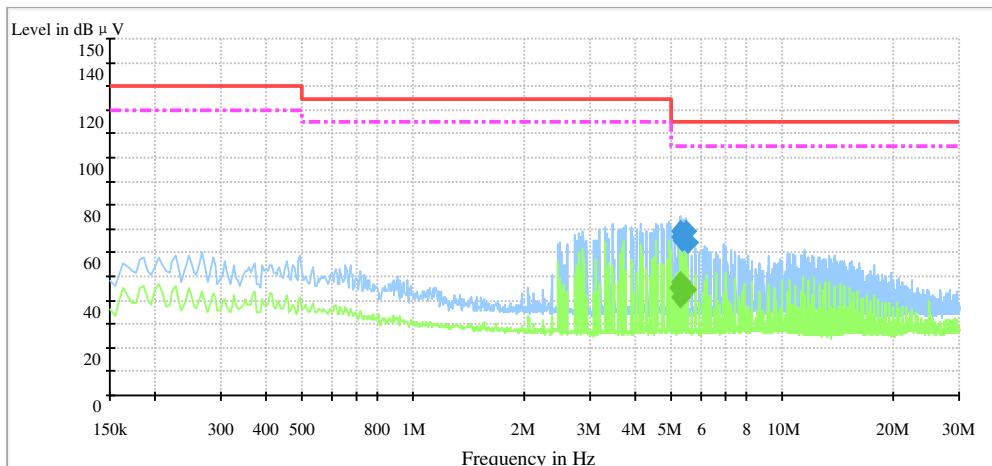



DC Mains

TEST MODE	SUN2000-100KTL-M1 Grid Mode(Full Load) + RS485 Data Acquisition	6dB BANDWIDTH	9 kHz
TEST VOLTAGE	DC 800V AC 400V	PHASE	Line (+)
ENVIRONMENTAL CONDITIONS	25 deg. C, 50% RH	TESTED BY: XUEHAIFENG	

Frequency (MHz)	QuasiPeak (dB μ V)	CAverage (dB μ V)	Limit (dB μ)	Margin (dB)	Meas. Time (ms)	Bandwidth (kHz)	Line	Filter
0.163501	---	63.85	73.24	9.38	1000.0	9.000	L1	OFF
0.163501	69.11	---	83.24	14.13	1000.0	9.000	L1	OFF
0.181501	64.16	---	82.33	18.17	1000.0	9.000	L1	OFF
0.186001	---	57.86	72.11	14.25	1000.0	9.000	L1	OFF
0.262501	---	57.05	69.17	12.12	1000.0	9.000	L1	OFF
0.348001	61.57	---	76.88	15.31	1000.0	9.000	L1	OFF
0.348001	---	55.26	66.86	11.60	1000.0	9.000	L1	OFF
4.174614	---	48.07	64.00	15.93	1000.0	9.000	L1	OFF
4.273096	58.03	---	74.00	15.97	1000.0	9.000	L1	OFF
4.277551	59.54	---	74.00	14.46	1000.0	9.000	L1	OFF
4.291096	---	47.20	64.00	16.80	1000.0	9.000	L1	OFF
4.389579	57.70	---	74.00	16.30	1000.0	9.000	L1	OFF

Full Spectrum

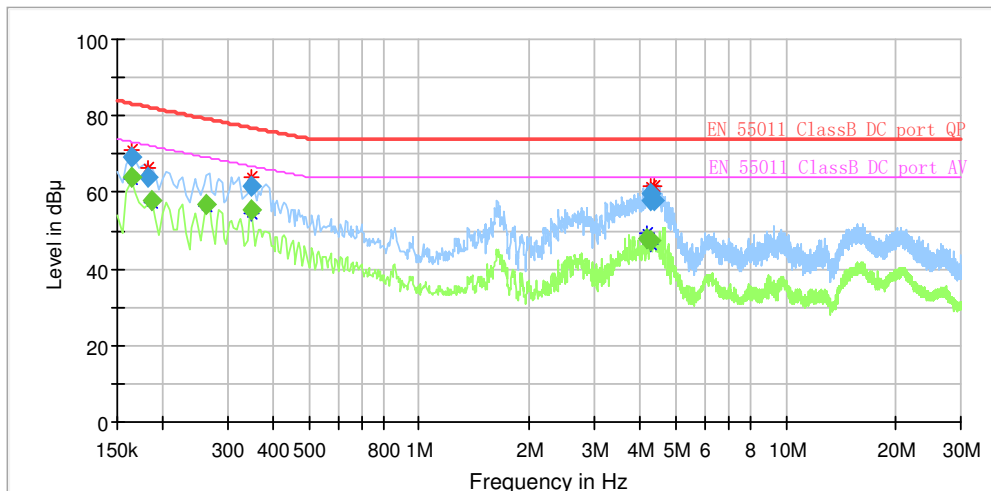



**BUREAU
VERITAS**

Test Report No.: CE2312WDG0186

TEST MODE	SUN2000-100KTL-M1 Grid Mode(Full Load) + RS485 Data Acquisition	6dB BANDWIDTH	9 kHz
TEST VOLTAGE	DC 800V AC 400V	PHASE	Line (-)
ENVIRONMENTAL CONDITIONS	25 deg. C, 50% RH	TESTED BY: XUEHAIFENG	

Frequency (MHz)	QuasiPeak (dB μ V)	CAverage (dB μ V)	Limit (dB μ)	Margin (dB)	Meas. Time (ms)	Bandwidth (kHz)	Line	Filter
0.150000	---	58.29	74.00	15.71	1000.0	9.000	L1	OFF
0.150000	63.90	---	84.00	20.10	1000.0	9.000	N	OFF
0.159000	63.20	---	83.49	20.28	1000.0	9.000	L1	OFF
0.163500	---	59.20	73.24	14.03	1000.0	9.000	N	OFF
0.181500	62.43	---	82.33	19.90	1000.0	9.000	N	OFF
0.222000	---	58.63	70.58	11.96	1000.0	9.000	L1	OFF
0.226500	63.47	---	80.43	16.97	1000.0	9.000	N	OFF
0.240000	---	57.37	69.92	12.55	1000.0	9.000	N	OFF
0.240000	61.33	---	79.95	18.62	1000.0	9.000	L1	OFF
0.285000	57.98	---	78.51	20.53	1000.0	9.000	L1	OFF
0.289500	---	53.11	68.36	15.25	1000.0	9.000	L1	OFF
0.334500	---	56.57	67.18	10.61	1000.0	9.000	L1	OFF

Full Spectrum

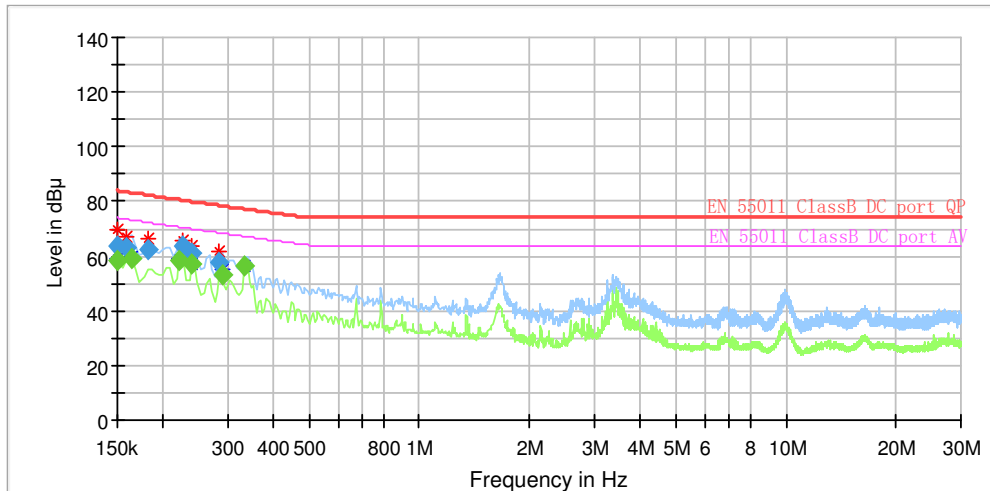

**Bureau Veritas Shenzhen Co., Ltd.
Dongguan Branch**

No. 96, Guantai Road (Houjie Section), Houjie
Town, Dongguan City, Guangdong Province.
523942. People's Republic of China

Tel: +86 769 8998 2098
Fax: +86 769 8593 1080
Email: customerservice.dg@bureauveritas.com



TEST MODE	SUN2000-100KTL-M1 Grid Mode(Full Load) + RS485 Data Acquisition	6dB BANDWIDTH	9 kHz
TEST VOLTAGE	DC 600V AC 480V	PHASE	Line (+)
ENVIRONMENTAL CONDITIONS	25 deg. C, 50% RH	TESTED BY: Wang Jia	

Frequency (MHz)	QuasiPeak (dB μ V)	Meas. Time (ms)	Bandwidth (kHz)	Filter	Line	Corr. (dB)	Margin (dB)	Limit (dB μ V)	Comment
0.163500	66.6	1000.0	9.000	On	+	21.0	65.2	131.7	
0.186000	60.7	1000.0	9.000	On	+	20.7	70.7	131.4	
0.357000	57.2	1000.0	9.000	On	+	19.5	72.2	129.5	
16.268632	36.2	1000.0	9.000	On	+	19.8	74.3	110.5	
24.346718	37.0	1000.0	9.000	On	+	21.1	69.9	106.9	
28.336058	35.5	1000.0	9.000	On	+	21.5	70.0	105.5	
Frequency (MHz)	Average (dB μ V)	Meas. Time (ms)	Bandwidth (kHz)	Filter	Line	Corr. (dB)	Margin (dB)	Limit (dB μ V)	Comment
0.163500	60.4	1000.0	9.000	On	+	21.0	61.3	121.7	
0.181500	55.2	1000.0	9.000	On	+	20.8	66.3	121.4	
0.217500	56.2	1000.0	9.000	On	+	20.4	64.7	120.9	
0.379499	53.1	1000.0	9.000	On	+	19.4	66.2	119.3	
24.068415	31.8	1000.0	9.000	On	+	21.1	62.4	94.3	
28.358558	30.3	1000.0	9.000	On	+	21.5	62.3	92.6	

Level in dB μ V

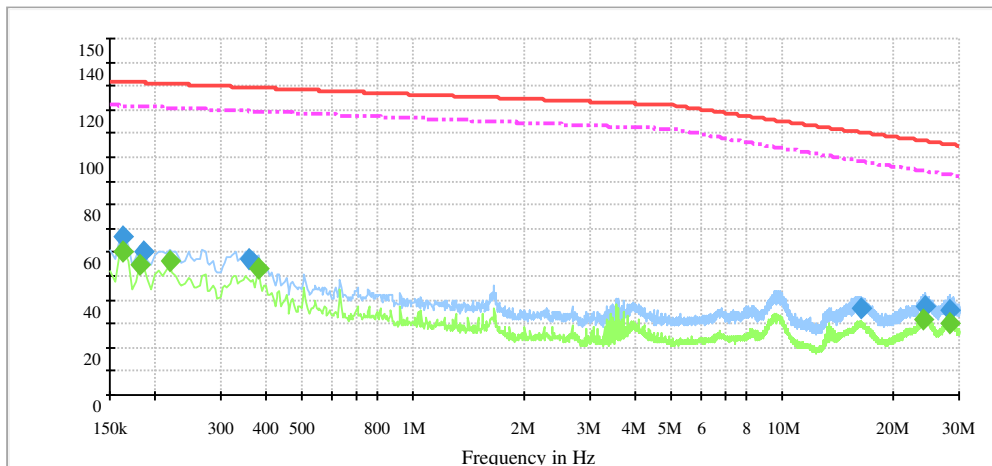



**BUREAU
VERITAS**

Test Report No.: CE2312WDG0186

TEST MODE	SUN2000-100KTL-M1 Grid Mode(Full Load) + RS485 Data Acquisition	6dB BANDWIDTH	9 kHz
TEST VOLTAGE	DC 800V AC 480V	PHASE	Line (-)
ENVIRONMENTAL CONDITIONS	25 deg. C, 50% RH	TESTED BY: Wang Jia	

Frequency (MHz)	QuasiPeak (dB μ V)	Meas. Time (ms)	Bandwidth (kHz)	Filter	Line	Corr. (dB)	Margin (dB)	Limit (dB μ V)	Comment
0.163500	67.1	1000.0	9.000	On	-	20.9	64.6	131.7	
0.186000	61.4	1000.0	9.000	On	-	20.6	70.0	131.4	
0.352500	58.9	1000.0	9.000	On	-	19.1	70.6	129.5	
9.828900	41.0	1000.0	9.000	On	-	19.2	74.3	115.3	
9.887858	40.9	1000.0	9.000	On	-	19.2	74.4	115.2	
29.859000	32.8	1000.0	9.000	On	-	21.3	72.3	105.0	
Frequency (MHz)	Average (dB μ V)	Meas. Time (ms)	Bandwidth (kHz)	Filter	Line	Corr. (dB)	Margin (dB)	Limit (dB μ V)	Comment
0.163500	60.6	1000.0	9.000	On	-	20.9	61.2	121.7	
0.217500	45.5	1000.0	9.000	On	-	20.1	75.4	120.9	
13.111950	37.1	1000.0	9.000	On	-	19.5	63.6	100.8	
13.232842	36.5	1000.0	9.000	On	-	19.5	64.1	100.6	
13.353735	36.7	1000.0	9.000	On	-	19.5	63.8	100.5	
28.778992	27.6	1000.0	9.000	On	-	21.3	64.8	92.4	

Level in dBuV

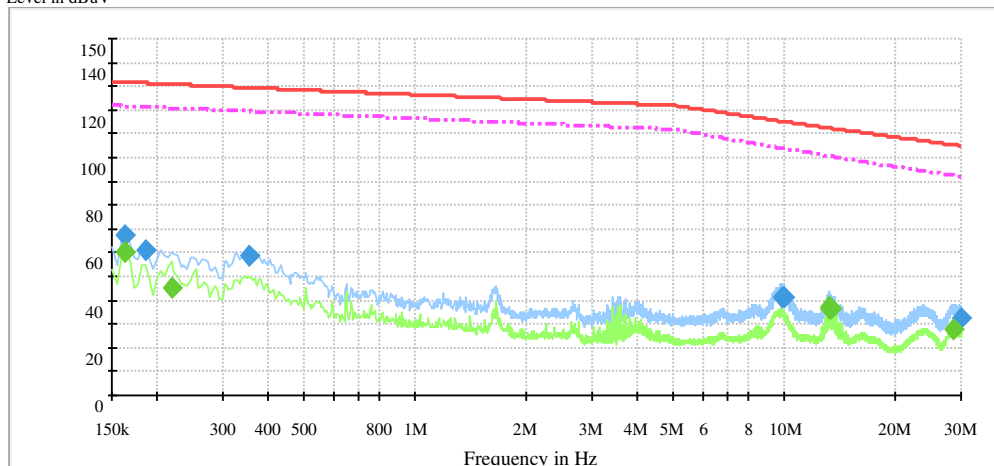

Bureau Veritas Shenzhen Co., Ltd.
Dongguan Branch

No. 96, Guantai Road (Houjie Section), Houjie
Town, Dongguan City, Guangdong Province.
523942. People's Republic of China

Tel: +86 769 8998 2098
Fax: +86 769 8593 1080
Email: customerservice.dg@bureauveritas.com



TEST MODE	SUN2000-100KTL-M1 Grid Mode(Full Load) + MBUS Data Acquisition	6dB BANDWIDTH	9 kHz
TEST VOLTAGE	DC 800V AC 480V	PHASE	Line (+)
ENVIRONMENTAL CONDITIONS	25 deg. C, 50% RH	TESTED BY: Wang Jia	

Frequency (MHz)	QuasiPeak (dB μV)	Meas. Time (ms)	Bandwidth (kHz)	Filter	Line	Corr. (dB)	Margin (dB)	Limit (dB μV)	Comment
5.074500	78.9	1000.0	9.000	On	+	38.9	42.9	121.8	
5.302920	79.0	1000.0	9.000	On	+	38.9	42.4	121.4	
5.307375	77.2	1000.0	9.000	On	+	38.9	44.2	121.4	
5.307488	76.8	1000.0	9.000	On	+	38.9	44.6	121.4	
5.459835	76.0	1000.0	9.000	On	+	38.9	45.1	121.1	
5.562705	80.1	1000.0	9.000	On	+	38.9	40.9	121.0	
Frequency (MHz)	Average (dB μV)	Meas. Time (ms)	Bandwidth (kHz)	Filter	Line	Corr. (dB)	Margin (dB)	Limit (dB μV)	Comment
4.076220	56.2	1000.0	9.000	On	+	38.9	56.4	112.6	
5.002860	55.6	1000.0	9.000	On	+	38.9	56.4	112.0	
5.280488	56.3	1000.0	9.000	On	+	38.9	55.0	111.3	
5.303032	55.0	1000.0	9.000	On	+	38.9	56.3	111.3	
5.316375	57.3	1000.0	9.000	On	+	38.9	53.9	111.2	
5.347830	58.1	1000.0	9.000	On	+	38.9	53.0	111.1	

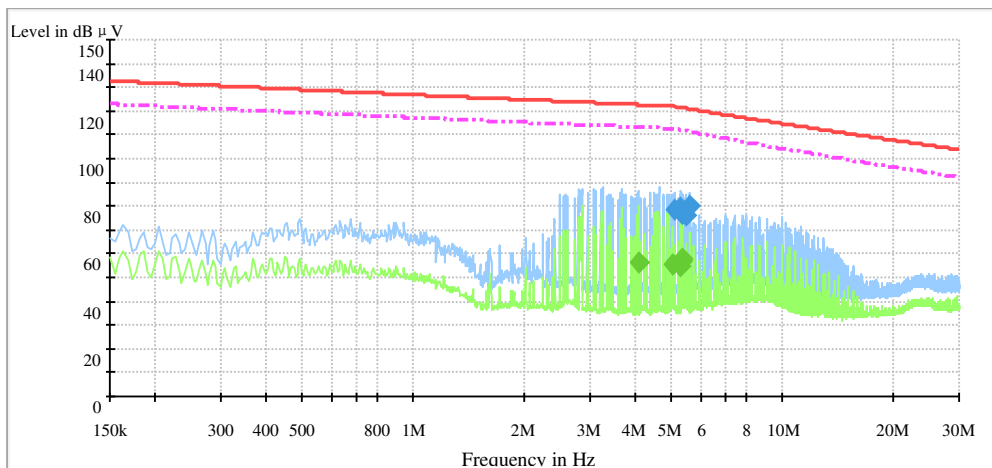



**BUREAU
VERITAS**

Test Report No.: CE2312WDG0186

TEST MODE	SUN2000-100KTL-M1 Grid Mode(Full Load) + MBUS Data Acquisition	6dB BANDWIDTH	9 kHz
TEST VOLTAGE	DC 800V AC 480V	PHASE	Line (-)
ENVIRONMENTAL CONDITIONS	25 deg. C, 50% RH	TESTED BY: Wang Jia	

Frequency (MHz)	QuasiPeak (dB μ V)	Meas. Time (ms)	Bandwidth (kHz)	Filter	Line	Corr. (dB)	Margin (dB)	Limit (dB μ V)	Comment
5.029725	80.4	1000.0	9.000	On	-	39.0	41.5	121.9	
5.159618	77.2	1000.0	9.000	On	-	39.0	44.5	121.7	
5.302965	79.8	1000.0	9.000	On	-	39.0	41.6	121.4	
5.338762	76.9	1000.0	9.000	On	-	39.0	44.5	121.4	
5.356628	76.2	1000.0	9.000	On	-	39.0	45.1	121.3	
5.414858	80.3	1000.0	9.000	On	-	39.1	40.9	121.2	
Frequency (MHz)	Average (dB μ V)	Meas. Time (ms)	Bandwidth (kHz)	Filter	Line	Corr. (dB)	Margin (dB)	Limit (dB μ V)	Comment
2.853705	58.7	1000.0	9.000	On	-	39.0	54.8	113.5	
4.931220	55.9	1000.0	9.000	On	-	39.0	56.1	112.0	
5.016315	55.0	1000.0	9.000	On	-	39.0	57.0	112.0	
5.320830	58.7	1000.0	9.000	On	-	39.0	52.5	111.2	
5.370262	59.4	1000.0	9.000	On	-	39.0	51.7	111.1	
5.379128	56.8	1000.0	9.000	On	-	39.0	54.3	111.1	

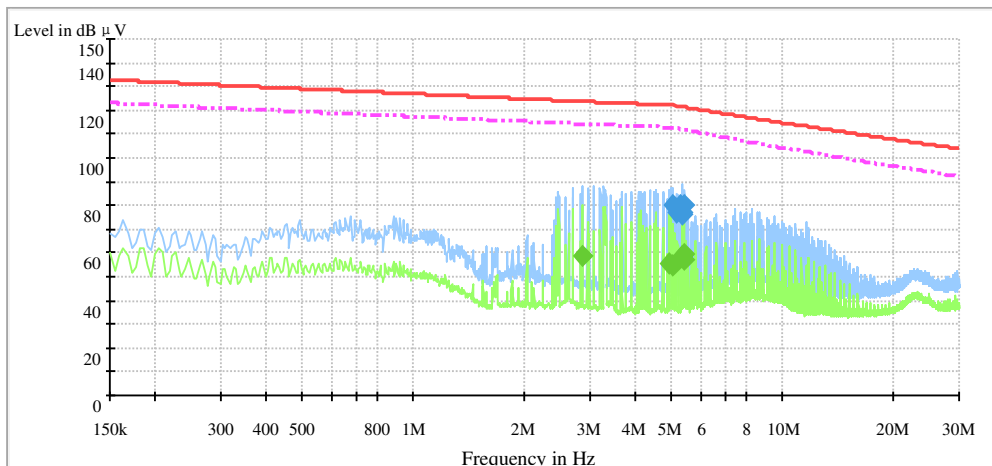

Bureau Veritas Shenzhen Co., Ltd.
Dongguan Branch

No. 96, Guantai Road (Houjie Section), Houjie
Town, Dongguan City, Guangdong Province.
523942. People's Republic of China

Tel: +86 769 8998 2098
Fax: +86 769 8593 1080
Email: customerservice.dg@bureauveritas.com



**BUREAU
VERITAS**

Test Report No.: CE2312WDG0186

AC Mains

TEST MODE	SUN2000-115KTL-M2 Grid Mode(Full Load) + RS485 Data Acquisition	6dB BANDWIDTH	9 kHz
TEST VOLTAGE	DC 800V AC 400V	PHASE	Line (L1)
ENVIRONMENTAL CONDITIONS	25 deg. C, 50% RH	TESTED BY: XUEHAIFENG	

Frequency (MHz)	QuasiPeak (dB μ V)	CAverage (dB μ V)	Limit (dB μ V)	Margin (dB)	Meas. Time (ms)	Bandwidth (kHz)	Line	Corr. (dB)
0.162010	---	45.21	55.30	10.09	1000.0	9.000	L1	21.4
0.162010	53.95	---	65.31	11.36	1000.0	9.000	L1	21.4
0.201510	47.68	---	63.39	15.71	1000.0	9.000	L1	21.3
0.202010	---	40.10	53.34	13.24	1000.0	9.000	L1	21.3
0.221510	---	36.19	52.54	16.35	1000.0	9.000	L1	21.3
0.226010	44.86	---	62.41	17.55	1000.0	9.000	L1	21.3
0.266010	---	38.67	51.00	12.32	1000.0	9.000	L1	21.3
0.267010	47.59	---	61.01	13.42	1000.0	9.000	L1	21.3
0.345510	45.10	---	58.90	13.79	1000.0	9.000	L1	21.3
0.345510	---	37.11	48.86	11.75	1000.0	9.000	L1	21.3
0.693509	---	28.74	46.00	17.26	1000.0	9.000	L1	21.2
0.698011	32.08	---	56.00	23.92	1000.0	9.000	L1	21.2

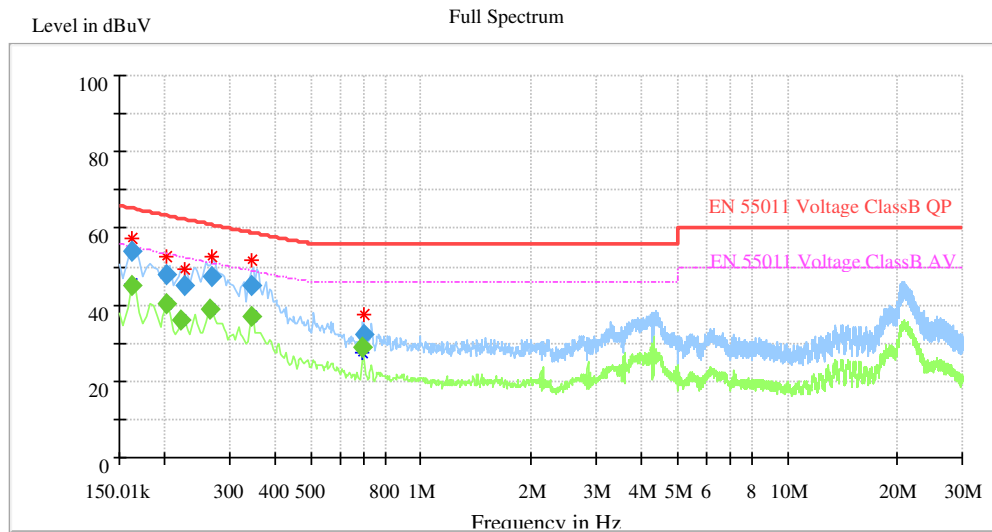

**Bureau Veritas Shenzhen Co., Ltd.
Dongguan Branch**

No. 96, Guantai Road (Houjie Section), Houjie
Town, Dongguan City, Guangdong Province.
523942. People's Republic of China

Tel: +86 769 8998 2098
Fax: +86 769 8593 1080
Email: customerservice.dg@bureauveritas.com



TEST MODE	SUN2000-115KTL-M2 Grid Mode(Full Load) + RS485 Data Acquisition	6dB BANDWIDTH	9 kHz
TEST VOLTAGE	DC 800V AC 400V	PHASE	Line (L2)
ENVIRONMENTAL CONDITIONS	25 deg. C, 50% RH	TESTED BY: XUEHAIFENG	

Frequency (MHz)	QuasiPeak (dB μ V)	CAverage (dB μ V)	Limit (dB μ V)	Margin (dB)	Meas. Time (ms)	Bandwidth (kHz)	Line	Corr. (dB)
0.150010	---	40.91	56.00	15.09	1000.0	9.000	L2	21.4
0.150010	54.69	---	66.00	11.31	1000.0	9.000	L2	21.4
0.162010	---	47.00	55.30	8.30	1000.0	9.000	L2	21.4
0.162010	54.97	---	65.31	10.34	1000.0	9.000	L2	21.4
0.182010	49.74	---	64.28	14.54	1000.0	9.000	L2	21.3
0.186010	---	40.53	54.07	13.53	1000.0	9.000	L2	21.3
4.242447	37.89	---	56.00	18.11	1000.0	9.000	L2	21.2
4.250907	---	33.49	46.00	12.51	1000.0	9.000	L2	21.2
4.287065	36.49	---	56.00	19.51	1000.0	9.000	L2	21.2
4.287065	---	36.15	46.00	9.85	1000.0	9.000	L2	21.2
4.327768	---	33.03	46.00	12.97	1000.0	9.000	L2	21.2
4.331189	39.25	---	56.00	16.75	1000.0	9.000	L2	21.2

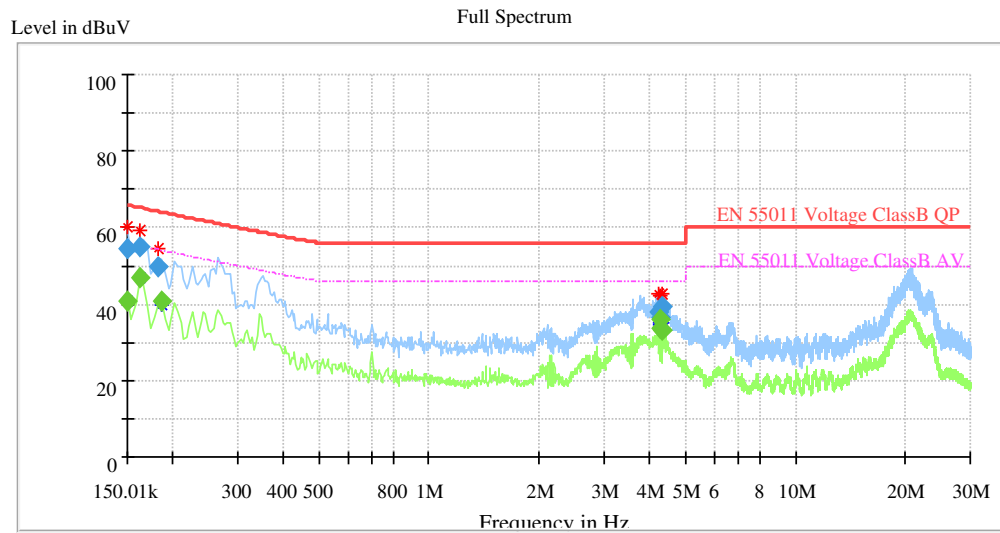



BUREAU VERITAS

Test Report No.: CE2312WDG0186

TEST MODE	SUN2000-115KTL-M2 Grid Mode(Full Load) + RS485 Data Acquisition	6dB BANDWIDTH	9 kHz
TEST VOLTAGE	DC 800V AC 400V	PHASE	Line (L3)
ENVIRONMENTAL CONDITIONS	25 deg. C, 50% RH	TESTED BY: XUEHAIFENG	

Frequency (MHz)	QuasiPeak (dB μ V)	CAverage (dB μ V)	Limit (dB μ V)	Margin (dB)	Meas. Time (ms)	Bandwidth (kHz)	Line	Corr. (dB)
0.150010	---	40.82	56.00	15.18	1000.0	9.000	L3	21.4
0.150010	55.15	---	66.00	10.85	1000.0	9.000	L3	21.4
0.161510	---	46.78	55.33	8.55	1000.0	9.000	L3	21.4
0.161510	54.52	---	65.34	10.82	1000.0	9.000	L3	21.4
0.346010	---	37.19	48.85	11.66	1000.0	9.000	L3	21.3
0.350510	45.10	---	58.78	13.68	1000.0	9.000	L3	21.2
4.240084	40.09	---	56.00	15.91	1000.0	9.000	L3	21.2
4.276016	---	32.36	46.00	13.64	1000.0	9.000	L3	21.2
4.284702	39.43	---	56.00	16.57	1000.0	9.000	L3	21.2
4.288685	---	29.11	46.00	16.89	1000.0	9.000	L3	21.2
4.306303	38.21	---	56.00	17.79	1000.0	9.000	L3	21.2
4.315866	---	32.65	46.00	13.35	1000.0	9.000	L3	21.2

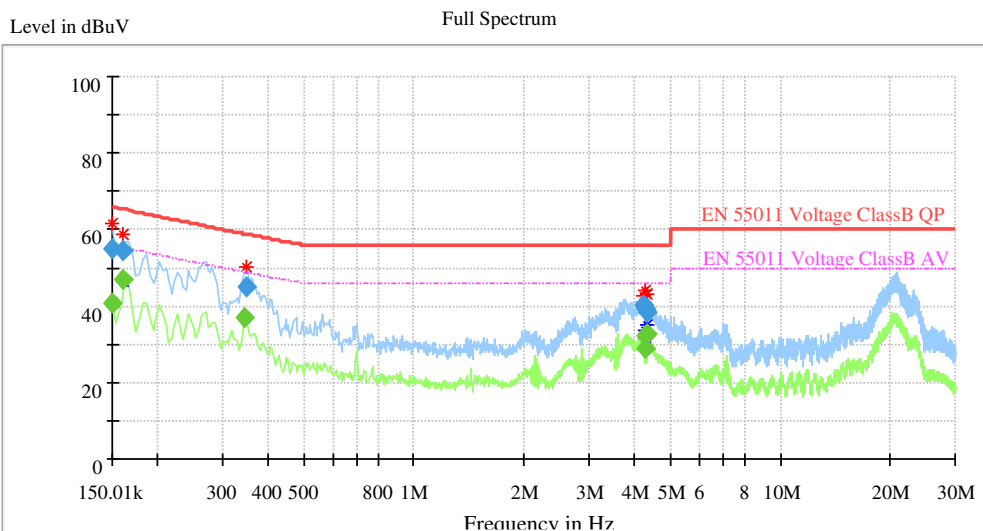

Bureau Veritas Shenzhen Co., Ltd.
Dongguan Branch

No. 96, Guantai Road (Houjie Section), Houjie
Town, Dongguan City, Guangdong Province.
523942. People's Republic of China

Tel: +86 769 8998 2098
Fax: +86 769 8593 1080
Email: customerservice.dg@bureauveritas.com



**BUREAU
VERITAS**

Test Report No.: CE2312WDG0186

TEST MODE	SUN2000-115KTL-M2 Grid Mode(Full Load) + RS485 Data Acquisition	6dB BANDWIDTH	9 kHz
TEST VOLTAGE	DC 800V AC 400V	PHASE	NEUTRAL (N)
ENVIRONMENTAL CONDITIONS	25 deg. C, 50% RH	TESTED BY: XUEHAIFENG	

Frequency (MHz)	QuasiPeak (dB μ V)	CAverage (dB μ V)	Limit (dB μ V)	Margin (dB)	Meas. Time (ms)	Bandwidth (kHz)	Line	Corr. (dB)
0.689510	40.45	---	56.00	15.55	1000.0	9.000	N	21.2
0.694010	---	38.15	46.00	7.85	1000.0	9.000	N	21.2
0.729510	35.45	---	56.00	20.55	1000.0	9.000	N	21.2
0.730010	---	34.05	46.00	11.95	1000.0	9.000	N	21.2
0.761510	---	26.58	46.00	19.42	1000.0	9.000	N	21.2
0.770011	32.87	---	56.00	23.13	1000.0	9.000	N	21.2
1.380105	29.72	---	56.00	26.28	1000.0	9.000	N	21.3
1.384605	---	24.09	46.00	21.91	1000.0	9.000	N	21.3
1.424746	28.63	---	56.00	27.37	1000.0	9.000	N	21.3
1.425263	---	28.27	46.00	17.73	1000.0	9.000	N	21.3
1.460904	---	25.86	46.00	20.14	1000.0	9.000	N	21.3
1.464842	30.32	---	56.00	25.68	1000.0	9.000	N	21.3

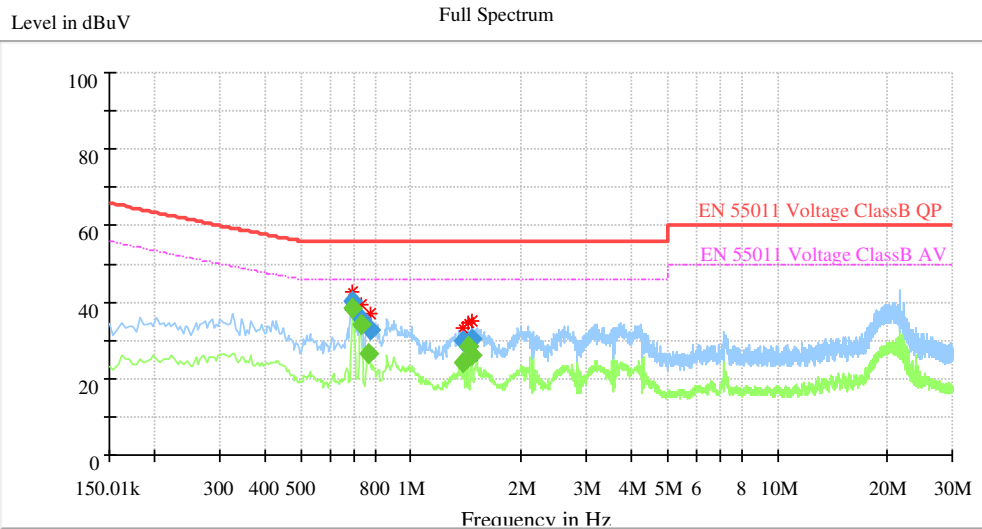

Bureau Veritas Shenzhen Co., Ltd.
Dongguan Branch

No. 96, Guantai Road (Houjie Section), Houjie
Town, Dongguan City, Guangdong Province.
523942. People's Republic of China

Tel: +86 769 8998 2098
Fax: +86 769 8593 1080
Email: customerservice.dg@bureauveritas.com



**BUREAU
VERITAS**

Test Report No.: CE2312WDG0186

TEST MODE	SUN2000-115KTL-M2 Grid Mode(Full Load) + MBUS Data Acquisition	6dB BANDWIDTH	9 kHz
TEST VOLTAGE	DC 850V AC 480V	PHASE	Line (L1)
ENVIRONMENTAL CONDITIONS	25 deg. C, 50% RH	TESTED BY: XUEHAIFENG	

Frequency (MHz)	QuasiPeak (dB μ V)	Average (dB μ V)	Meas. Time (ms)	Bandwidth (kHz)	PE	Line	Corr. (dB)	Limit (dB μ V)	Margin (dB)
1.268151	---	56.61	1000.0	9.000	GND	L1	10.0	115.00	58.39
1.268151	85.83	---	1000.0	9.000	GND	L1	10.0	125.00	39.17
1.400531	84.01	---	1000.0	9.000	GND	L1	10.0	125.00	40.99
2.276651	83.54	---	1000.0	9.000	GND	L1	10.1	125.00	41.46
2.363691	---	58.57	1000.0	9.000	GND	L1	10.1	115.00	56.43
2.880051	---	63.75	1000.0	9.000	GND	L1	10.1	115.00	51.25

Full Spectrum

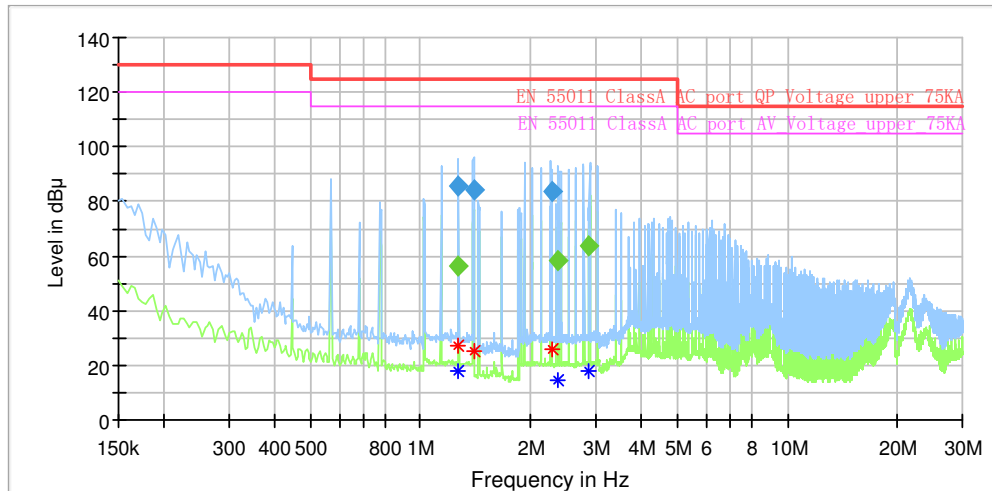

**Bureau Veritas Shenzhen Co., Ltd.
Dongguan Branch**

No. 96, Guantai Road (Houjie Section), Houjie Town, Dongguan City, Guangdong Province. 523942. People's Republic of China

Tel: +86 769 8998 2098
Fax: +86 769 8593 1080
Email: customerservice.dg@bureauveritas.com



TEST MODE	SUN2000-115KTL-M2 Grid Mode(Full Load) + MBUS Data Acquisition	6dB BANDWIDTH	9 kHz
TEST VOLTAGE	DC 850V AC 480V	PHASE	Line (L2)
ENVIRONMENTAL CONDITIONS	25 deg. C, 50% RH	TESTED BY: XUEHAIFENG	

Frequency (MHz)	QuasiPeak (dB μ V)	Average (dB μ V)	Meas. Time (ms)	Bandwidth (kHz)	PE	Line	Corr. (dB)	Limit (dB μ V)	Margin (dB)
1.824831	---	60.49	1000.0	9.000	GND	L2	10.1	115.00	54.51
1.843171	80.60	---	1000.0	9.000	GND	L2	10.1	125.00	44.40
2.159671	---	58.92	1000.0	9.000	GND	L2	10.1	115.00	56.08
2.175591	85.34	---	1000.0	9.000	GND	L2	10.1	125.00	39.66
2.719471	---	59.88	1000.0	9.000	GND	L2	10.1	115.00	55.12
2.719471	84.10	---	1000.0	9.000	GND	L2	10.1	125.00	40.90

Full Spectrum

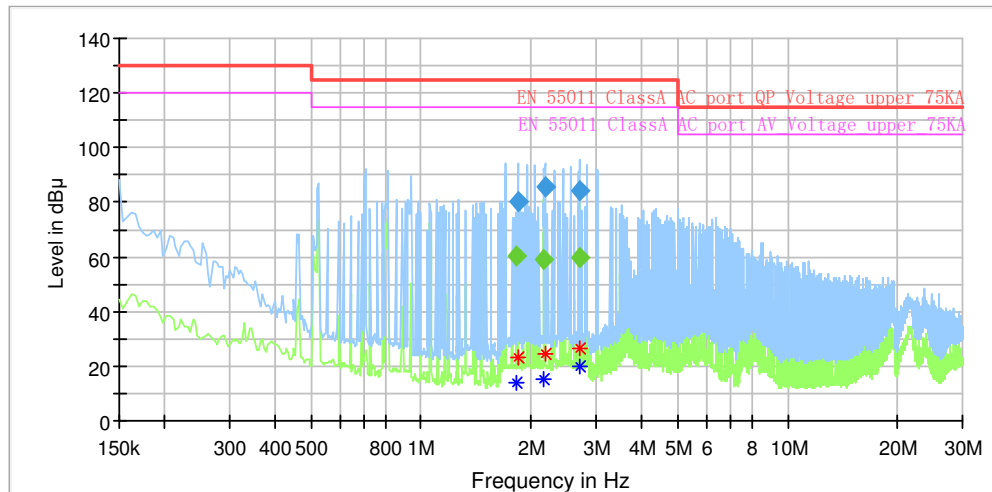



**BUREAU
VERITAS**

Test Report No.: CE2312WDG0186

TEST MODE	SUN2000-115KTL-M2 Grid Mode(Full Load) + MBUS Data Acquisition	6dB BANDWIDTH	9 kHz
TEST VOLTAGE	DC 850V AC 480V	PHASE	Line (L3)
ENVIRONMENTAL CONDITIONS	25 deg. C, 50% RH	TESTED BY: XUEHAIFENG	

Frequency (MHz)	QuasiPeak (dB μ V)	Average (dB μ V)	Meas. Time (ms)	Bandwidth (kHz)	PE	Line	Corr. (dB)	Limit (dB μ V)	Margin (dB)
1.201011	---	63.83	1000.0	9.000	GND	L3	10.0	115.00	51.17
1.745231	---	59.66	1000.0	9.000	GND	L3	10.1	115.00	55.34
3.406951	79.00	---	1000.0	9.000	GND	L3	10.1	125.00	46.00
5.198491	64.20	---	1000.0	9.000	GND	L3	10.2	115.00	50.80
5.563791	---	40.67	1000.0	9.000	GND	L3	10.2	105.00	64.33
6.715051	60.63	---	1000.0	9.000	GND	L3	10.2	115.00	54.37

Full Spectrum

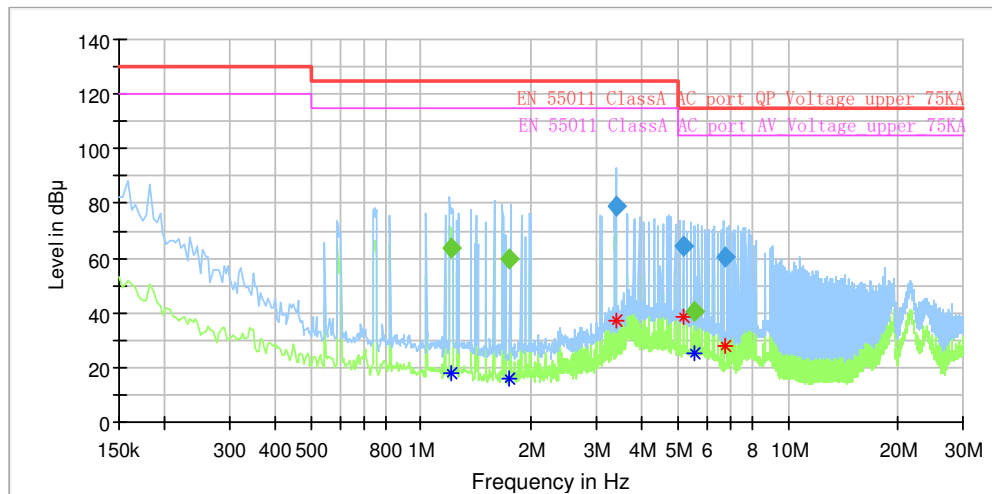

**Bureau Veritas Shenzhen Co., Ltd.
Dongguan Branch**

No. 96, Guantai Road (Houjie Section), Houjie Town, Dongguan City, Guangdong Province. 523942. People's Republic of China

Tel: +86 769 8998 2098
Fax: +86 769 8593 1080
Email: customerservice.dg@bureauveritas.com



TEST MODE	SUN2000-115KTL-M2 Grid Mode(Full Load) + MBUS Data Acquisition	6dB BANDWIDTH	9 kHz
TEST VOLTAGE	DC 850V AC 480V	PHASE	NEUTRAL (N)
ENVIRONMENTAL CONDITIONS	25 deg. C, 50% RH	TESTED BY: XUEHAIFENG	

Frequency (MHz)	QuasiPeak (dB μ V)	Average (dB μ V)	Meas. Time (ms)	Bandwidth (kHz)	PE	Line	Corr. (dB)	Limit (dB μ V)	Margin (dB)
5.002950	87.4	---	1000.0	9.000	GND	N	21.2	115.0	27.6
5.177618	87.2	---	1000.0	9.000	GND	N	21.2	115.0	27.8
5.437268	83.7	---	1000.0	9.000	GND	N	21.2	115.0	31.3
2.898435	---	66.8	1000.0	9.000	GND	N	21.2	115.0	48.2
5.195640	---	65.1	1000.0	9.000	GND	N	21.2	105.0	39.9
5.469210	---	66.4	1000.0	9.000	GND	N	21.2	105.0	38.6

Voltage with 4-Line-LISN ENV4200

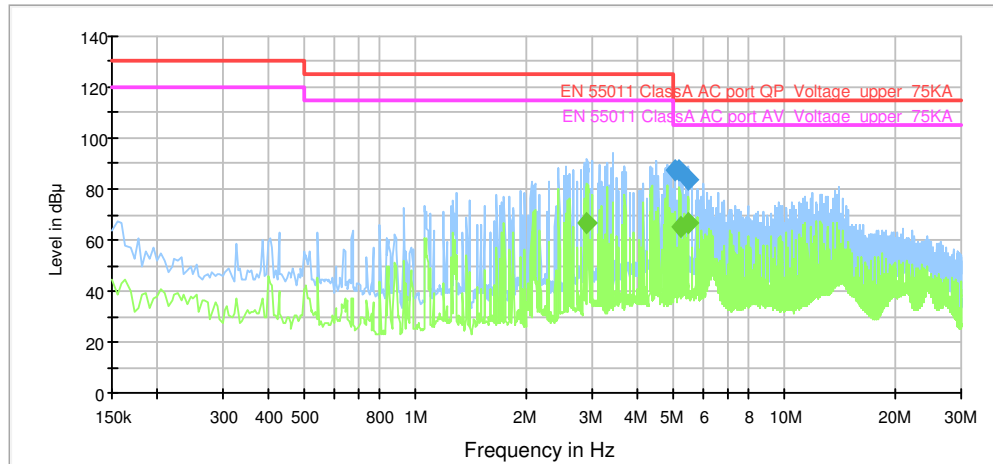



DC Mains

TEST MODE	SUN2000-115KTL-M2 Grid Mode(Full Load) + RS485 Data Acquisition	6dB BANDWIDTH	9 kHz
TEST VOLTAGE	DC 800V AC 400V	PHASE	Line (+)
ENVIRONMENTAL CONDITIONS	25 deg. C, 50% RH	TESTED BY: XUEHAIFENG	

Frequency (MHz)	QuasiPeak (dB μ V)	CAverage (dB μ V)	Limit (dB μ)	Margin (dB)	Meas. Time (ms)	Bandwidth (kHz)	Line	Filter
0.163501	---	63.47	73.24	9.77	1000.0	9.000	L1	OFF
0.163501	68.52	---	83.24	14.72	1000.0	9.000	L1	OFF
0.204001	---	57.89	71.31	13.42	1000.0	9.000	L1	OFF
0.204001	64.07	---	81.32	17.25	1000.0	9.000	L1	OFF
0.267001	---	56.51	69.03	12.52	1000.0	9.000	L1	OFF
0.384000	60.63	---	76.09	15.46	1000.0	9.000	L1	OFF
0.388501	---	53.33	65.98	12.65	1000.0	9.000	L1	OFF
4.116984	---	45.41	64.00	18.59	1000.0	9.000	L1	OFF
4.120906	56.84	---	74.00	17.16	1000.0	9.000	L1	OFF
4.201479	58.22	---	74.00	15.78	1000.0	9.000	L1	OFF
4.295484	---	46.78	64.00	17.22	1000.0	9.000	L1	OFF
4.313461	55.57	---	74.00	18.43	1000.0	9.000	L1	OFF

Full Spectrum

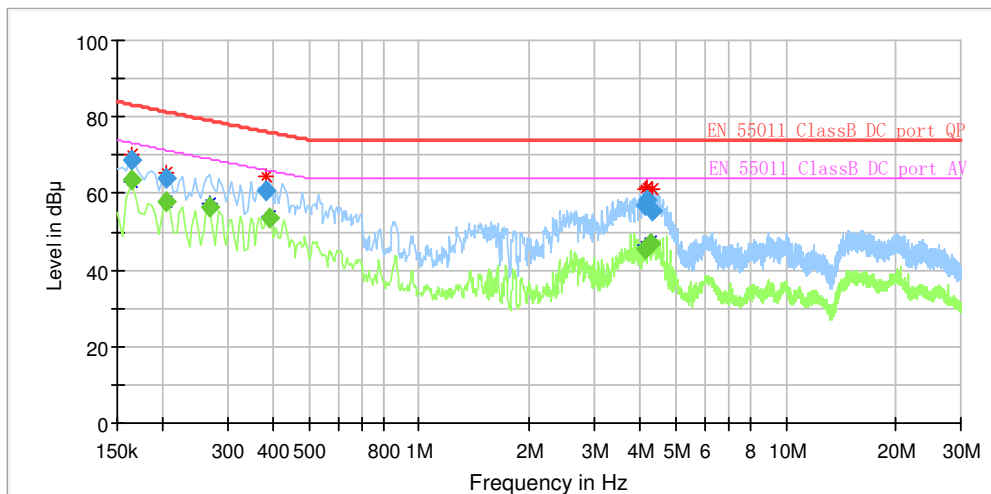



TEST MODE	SUN2000-115KTL-M2 Grid Mode(Full Load) + RS485 Data Acquisition	6dB BANDWIDTH	9 kHz
TEST VOLTAGE	DC 800V AC 400V	PHASE	Line (-)
ENVIRONMENTAL CONDITIONS	25 deg. C, 50% RH	TESTED BY: XUEHAIFENG	

Frequency (MHz)	QuasiPeak (dB μ V)	CAverage (dB μ V)	Limit (dB μ)	Margin (dB)	Meas. Time (ms)	Bandwidth (kHz)	Line	Filter
0.163501	---	63.85	73.24	9.38	1000.0	9.000	N	OFF
0.163501	69.11	---	83.24	14.13	1000.0	9.000	N	OFF
0.181501	64.16	---	82.33	18.17	1000.0	9.000	N	OFF
0.186001	---	57.86	72.11	14.25	1000.0	9.000	N	OFF
0.262501	---	57.05	69.17	12.12	1000.0	9.000	N	OFF
0.348001	61.57	---	76.88	15.31	1000.0	9.000	N	OFF
0.348001	---	55.26	66.86	11.60	1000.0	9.000	N	OFF
4.174614	---	48.07	64.00	15.93	1000.0	9.000	N	OFF
4.273096	58.03	---	74.00	15.97	1000.0	9.000	N	OFF
4.277551	59.54	---	74.00	14.46	1000.0	9.000	N	OFF
4.291096	---	47.20	64.00	16.80	1000.0	9.000	N	OFF
4.389579	57.70	---	74.00	16.30	1000.0	9.000	N	OFF

Full Spectrum

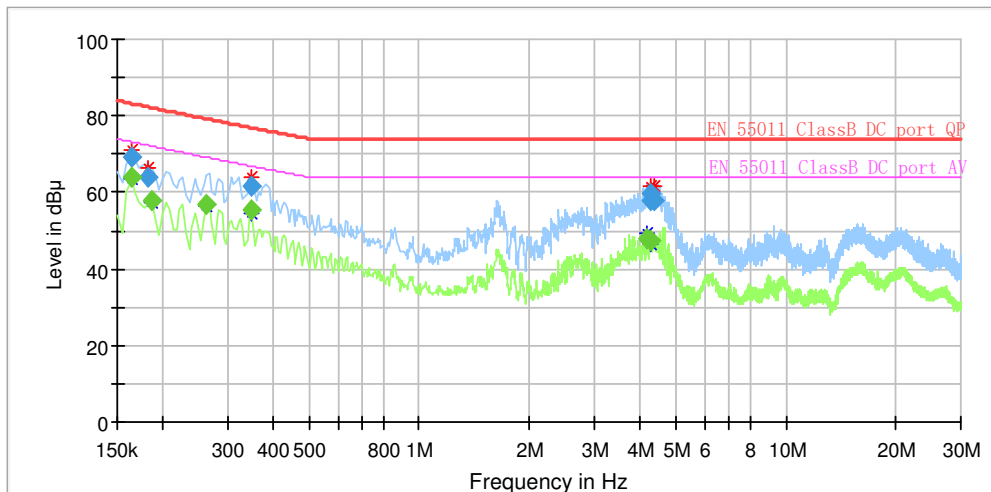



**BUREAU
VERITAS**

Test Report No.: CE2312WDG0186

TEST MODE	SUN2000-115KTL-M2 Grid Mode(Full Load) + MBUS Data Acquisition	6dB BANDWIDTH	9 kHz
TEST VOLTAGE	DC 720V AC 480V	PHASE	Line (+)
ENVIRONMENTAL CONDITIONS	25 deg. C, 50% RH	TESTED BY: XUEHAIFENG	

Frequency (MHz)	QuasiPeak (dB μ V)	Meas. Time (ms)	Bandwidth (kHz)	Filter	Line	Corr. (dB)	Margin (dB)	Limit (dB μ V)	Comment
2.594055	81.90	1000.0	9.000	On	+	29.0	41.91	123.81	
2.911890	83.14	1000.0	9.000	On	+	29.1	40.35	123.49	
3.153765	84.18	1000.0	9.000	On	+	29.1	39.09	123.27	
3.632813	79.85	1000.0	9.000	On	+	29.1	43.03	122.88	
Frequency (MHz)	Average (dB μ V)	Meas. Time (ms)	Bandwidth (kHz)	Filter	Line	Corr. (dB)	Margin (dB)	Limit (dB μ V)	Comment
0.690000	58.48	1000.0	9.000	On	+	28.8	59.06	117.54	
1.586595	63.58	1000.0	9.000	On	+	28.8	51.60	115.18	
2.656763	62.23	1000.0	9.000	On	+	29.1	51.51	113.74	
3.140265	60.44	1000.0	9.000	On	+	29.1	52.84	113.28	

Full Spectrum

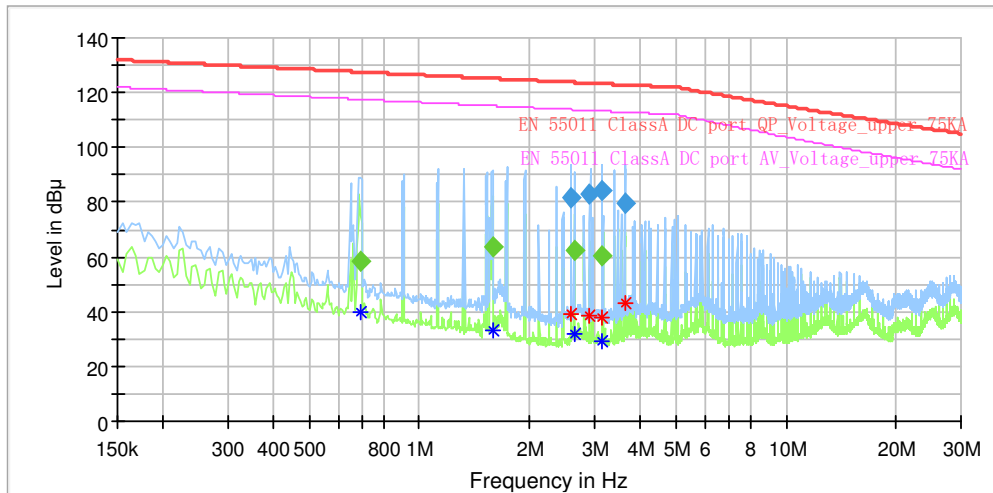

**Bureau Veritas Shenzhen Co., Ltd.
Dongguan Branch**

No. 96, Guantai Road (Houjie Section), Houjie
Town, Dongguan City, Guangdong Province.
523942. People's Republic of China

Tel: +86 769 8998 2098
Fax: +86 769 8593 1080
Email: customerservice.dg@bureauveritas.com



**BUREAU
VERITAS**

Test Report No.: CE2312WDG0186

TEST MODE	SUN2000-115KTL-M2 Grid Mode(Full Load) + MBUS Data Acquisition	6dB BANDWIDTH	9 kHz
TEST VOLTAGE	DC 720V AC 480V	PHASE	Line (-)
ENVIRONMENTAL CONDITIONS	25 deg. C, 50% RH	TESTED BY: XUEHAIFENG	

Frequency (MHz)	QuasiPeak (dB μ V)	Meas. Time (ms)	Bandwidth (kHz)	Filter	Line	Corr. (dB)	Margin (dB)	Limit (dB μ V)	Comment
2.941133	80.4	1000.0	9.000	On	-	29.0	42.55	121.9	
3.406950	77.2	1000.0	9.000	On	-	29.1	43.45	121.7	
3.606038	79.8	1000.0	9.000	On	-	29.1	43.15	121.4	
Frequency (MHz)	Average (dB μ V)	Meas. Time (ms)	Bandwidth (kHz)	Filter	Line	Corr. (dB)	Margin (dB)	Limit (dB μ V)	Comment
0.910470	58.7	1000.0	9.000	On	-	28.8	58.63	116.75	
1.134323	55.9	1000.0	9.000	On	-	28.8	63.30	116.13	
3.406950	55.0	1000.0	9.000	On	-	29.1	61.20	113.05	

Full Spectrum

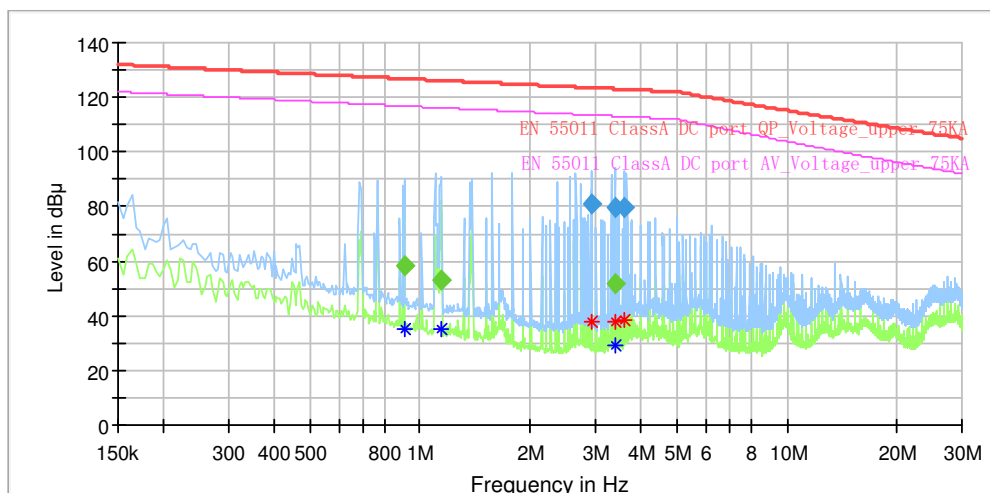

**Bureau Veritas Shenzhen Co., Ltd.
Dongguan Branch**

No. 96, Guantai Road (Houjie Section), Houjie
Town, Dongguan City, Guangdong Province.
523942. People's Republic of China

Tel: +86 769 8998 2098
Fax: +86 769 8593 1080
Email: customerservice.dg@bureauveritas.com



3.2 CONDUCTED EMISSION MEASUREMENT AT TELECOMMUNICATION PORTS

3.2.1 LIMIT OF CONDUCTED COMMON MODE DISTURBANCE AT TELECOMMUNICATION PORTS

TEST STANDARD: EN IEC 61000-6-3, EN IEC 61000-6-4
FOR CLASS B EQUIPMENT

FREQUENCY (MHz)	Voltage Limit (dBuV)		Current Limit (dBuA)	
	Quasi-peak	Average	Quasi-peak	Average
0.15 - 0.5	84 - 74	74 - 64	40 - 30	30 - 20
0.5 - 30.0	74	64	30	20

FOR CLASS A EQUIPMENT

FREQUENCY (MHz)	Voltage Limit (dBuV)		Current Limit (dBuA)	
	Quasi-peak	Average	Quasi-peak	Average
0.15 - 0.5	97 - 87	84 - 74	53 - 43	40 - 30
0.5 - 30.0	87	74	43	30

NOTE: (1) The limits decrease linearly with the logarithm of the frequency in the range 0.15 MHz to 0.5 MHz.

3.2.2 TEST INSTRUMENTS

Equipment	Manufacturer	Model No.	Serial No.	Last Cal.	Next Cal.
EMI Test Receiver	Rohde&Schwarz	ESC13	101019	Jun. 03, 2019	Jun. 02, 2020
Artificial Mains Network	Rohde&Schwarz	ENV4200	100141	Feb. 18, 2019	Feb. 17, 2020
DC Artificial Network	SCHWARZBECK	PVDC 8301 RC	8301-RC 01000	Feb. 18, 2019	Feb. 17, 2020
DC Artificial Network	SCHWARZBECK	PVDC 8301	8301-37	Feb. 18, 2019	Feb. 17, 2020
DC Artificial Network	SCHWARZBECK	PVDC 8301	8301-35	Apr. 17, 2019	Apr. 16, 2020
Current probe	FCC	F-52	111659	Jan. 18, 2019	Jan. 17, 2020

Equipment	Manufacturer	Model No.	Serial No.	Last Cal.	Next Cal.
EMI Test Receiver	Rohde&Schwarz	ESC13	101019	2020/07/03	2021/07/02
Artificial Mains Network	Rohde&Schwarz	ENV4200	100141	2020/02/26	2021/02/25
DC Artificial Network	SCHWARZBECK	PVDC 8301 RC	01000	2020/02/26	2021/02/25
DC Artificial Network	SCHWARZBECK	PVDC 8301	8301-37	2020/08/29	2021/08/28
DC Artificial Network	SCHWARZBECK	PVDC 8301	8301-35	2020/04/10	2021/04/09
100Ω Resistance	LUTHI	100Ω Resistance	370	2020/04/28	2021/04/27
Current probe	FCC	F-52	111659	2020/05/13	2021/05/12

NOTE: 1. The test was performed by witness in conducted shielding room of Shanghai Testing & Inspection Institute for Electrical Equipment.
2. The test was performed in Conducted shielding room.

Bureau Veritas Shenzhen Co., Ltd.
Dongguan Branch

No. 96, Guantai Road (Houjie Section), Houjie Town, Dongguan City, Guangdong Province. 523942. People's Republic of China

Tel: +86 769 8998 2098
Fax: +86 769 8593 1080
Email: customerservice.dg@bureauveritas.com



3.2.3 TEST PROCEDURE

For using ISN:

- a. The EUT is placed 0.4 meters from the conducting wall of the shielded room and connected to ISN directly to reference ground plane.
- b. If voltage measurement is used, measure voltage at the measurement port of the ISN, correct the reading by adding the ISN voltage division factor, and compare to the voltage limit.
- c. If current measurement is used, measure current with the current probe and compare to the current limit.
- d. It is not necessary to apply the voltage and the current limit if the ISN is used. A 50 Ω load has to be connected to the measurement port of the ISN during the current measurement.
- e. The disturbance levels and the frequencies of at least six highest disturbances are recorded from be measured each telecommunication port, which comprises the EUT.

For using a 150 Ω load to the outside surface of the shield cable:

- a. Break the insulation and connect a 150 Ω resistor from the outside surface of the shield cable to ground, and apply a ferrite tube or clamp between 150 Ω connection and AE.
- b. The EUT is placed 0.4 meters from the conducting wall of the shielded room and connected to AE with the shield cable.
- c. Measure current with a current probe and compare to the current limit. The common mode impedance towards the right of the 150 Ω resistor.
- d. The disturbance levels and the frequencies of at least six highest disturbances are recorded from be measured each telecommunication port, which comprises the EUT.



For using a combination of current probe and capacitive voltage probe:

- a. The EUT is placed 0.4 meters from the conducting wall of the shielded room and connected to AE with a cable. The cable contains more than four balanced pairs or to unbalanced cable.
- b. Measure current with a current probe and compare to the current limit.
- c. Measure voltage with a capacitive probe and adjust the measured voltage as follows:
- d. – current margin ≤ 6 dB – subtract the actual current margin from measured voltage;
- e. – current margin > 6 dB – subtract 6 dB from measured voltage.
- f. Compare adjusted voltage with the applicable voltage limit.
- g. Both the measured current and the adjusted voltage shall be below the applicable current and voltage limits.
- h. The disturbance levels and the frequencies of at least six highest disturbances are recorded from be measured each telecommunication port, which comprises the EUT.

3.2.4 DEVIATION FROM TEST STANDARD

No deviation



3.2.5 TEST SETUP

For using ISN:

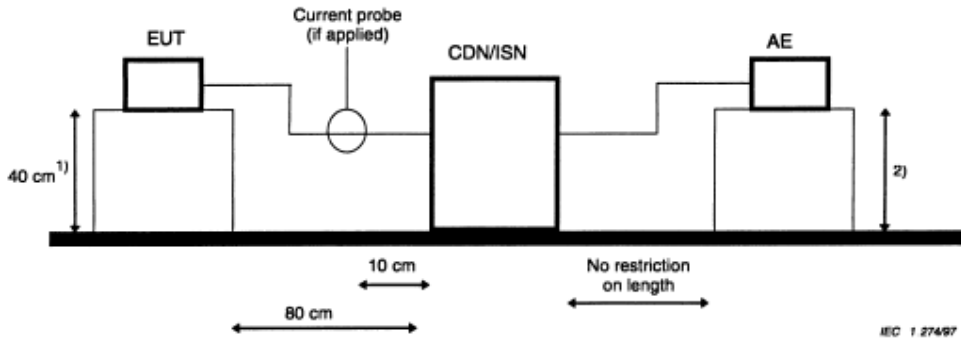

AE = Associated equipment
EUT = Equipment under test

- 1) Distance to the reference groundplane (vertical or horizontal).
- 2) Distance to the reference groundplane is not critical.

For using a 150 Ω load to the outside surface of the shield cable:

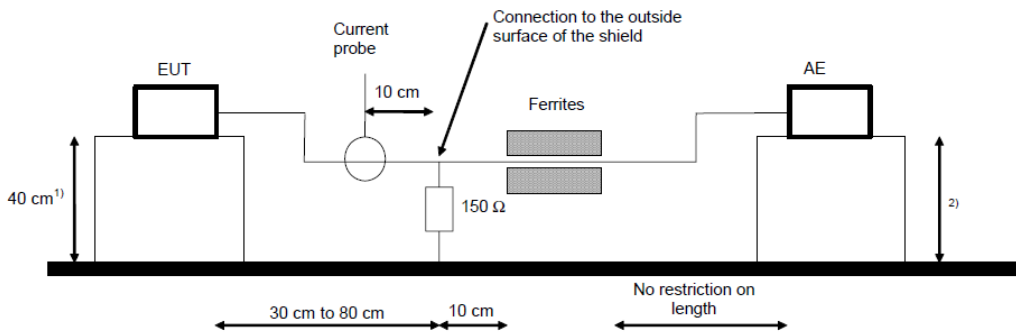

AE = Associated equipment
EUT = Equipment under test

- 1) Distance to the reference groundplane (vertical or horizontal).
- 2) Distance to the reference groundplane is not critical.



For using a combination of current probe and capacitive voltage probe:

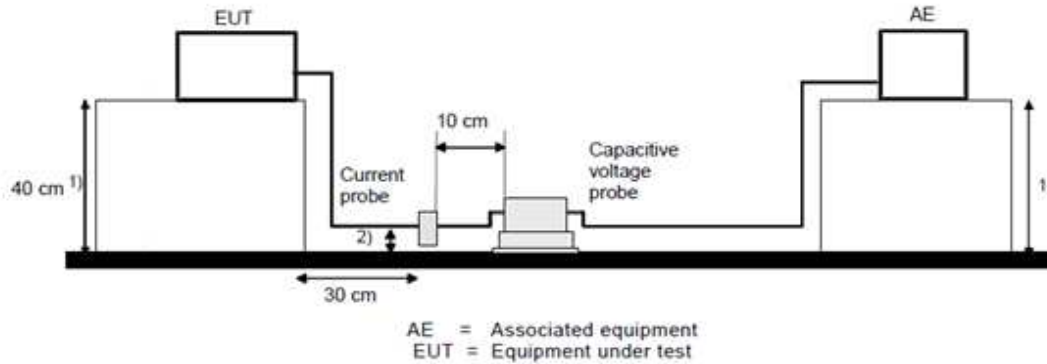

1) Distance to the reference groundplane (vertical or horizontal)

2) Distance 4 ± 1 cm from the reference groundplane.

For the actual test configuration, please refer to the related item – Photographs of the Test Configuration.

3.2.6 EUT OPERATING CONDITIONS

Same as item 3.1.6



3.2.7 TEST RESULTS

TEST MODE	SUN2000-100KTL-M1 Grid Mode(10% Load) + RS485 Data Acquisition	6dB BANDWIDTH	9kHz
TEST VOLTAGE	DC 1000V AC 400V	PHASE	RS485 PORT (RJ45 Cable)
ENVIRONMENTAL CONDITIONS	25 deg. C, 50% RH	TEST BY	Wang Jia

Frequency (MHz)	QuasiPeak (dB μ A)	Meas. Time (ms)	Bandwidth (kHz)	Corr. (dB)	Margin (dB)	Limit (dB μ A)	Comment
0.163500	21.6	1000.0	9.000	13.3	17.6	39.2	
0.204000	21.3	1000.0	9.000	12.0	15.8	37.2	
0.572999	22.1	1000.0	9.000	4.9	7.9	30.0	
0.640500	20.3	1000.0	9.000	4.2	9.7	30.0	
1.783538	8.2	1000.0	9.000	0.3	21.8	30.0	
2.894070	10.4	1000.0	9.000	-2.2	19.6	30.0	

Frequency (MHz)	Average (dB μ A)	Meas. Time (ms)	Bandwidth (kHz)	Corr. (dB)	Margin (dB)	Limit (dB μ A)	Comment
0.163500	16.5	1000.0	9.000	13.3	12.6	29.1	
0.213000	16.1	1000.0	9.000	11.7	10.5	26.7	
0.572999	16.4	1000.0	9.000	4.9	3.6	20.0	
0.640500	13.5	1000.0	9.000	4.2	6.5	20.0	
1.998480	7.9	1000.0	9.000	-0.2	12.1	20.0	
2.083552	8.3	1000.0	9.000	-0.4	11.7	20.0	

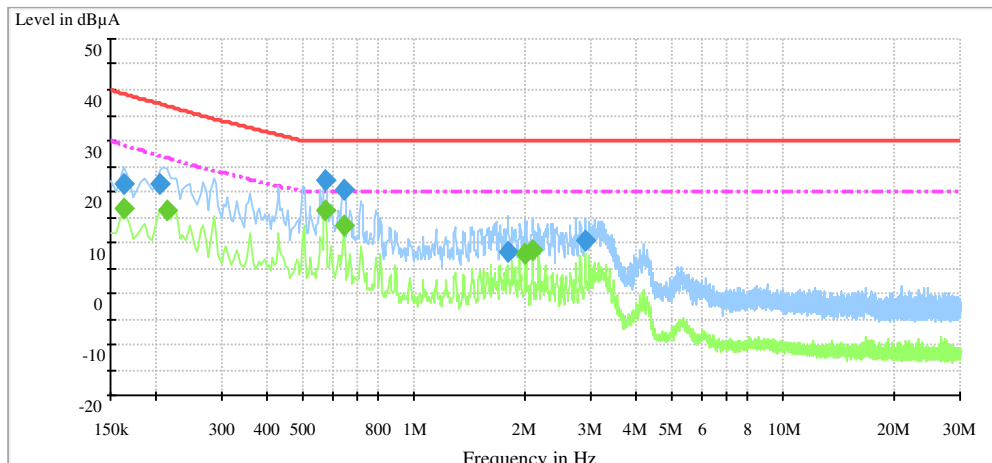



TEST MODE	SUN2000-100KTL-M1 Grid Mode(Full Load) + RS485 Data Acquisition	6dB BANDWIDTH	9kHz
TEST VOLTAGE	DC 600V AC 480V	PHASE	RS485 PORT (RJ45 Cable)
ENVIRONMENTAL CONDITIONS	25 deg. C, 50% RH	TEST BY	Wang Jia

Frequency (MHz)	QuasiPeak (dB μ A)	Meas. Time (ms)	Bandwidth (kHz)	Corr. (dB)	Margin (dB)	Limit (dB μ A)	Comment
0.186000	26.3	1000.0	9.000	3.5	24.8	51.1	
0.289500	22.0	1000.0	9.000	-0.8	25.3	47.3	
0.348000	22.8	1000.0	9.000	-1.9	23.0	45.8	
0.424500	21.1	1000.0	9.000	-3.1	23.1	44.2	
0.618000	18.1	1000.0	9.000	-5.4	24.9	43.0	
0.708000	16.7	1000.0	9.000	-6.2	26.3	43.0	
Frequency (MHz)	Average (dB μ A)	Meas. Time (ms)	Bandwidth (kHz)	Corr. (dB)	Margin (dB)	Limit (dB μ A)	Comment
0.181500	18.3	1000.0	9.000	3.7	19.9	38.2	
0.276000	14.4	1000.0	9.000	-0.2	20.2	34.6	
0.429000	13.2	1000.0	9.000	-3.2	17.9	31.1	
0.613500	10.0	1000.0	9.000	-5.4	20.0	30.0	
0.698998	9.7	1000.0	9.000	-6.2	20.3	30.0	
1.223872	6.9	1000.0	9.000	-8.4	23.1	30.0	

Level in dBuA

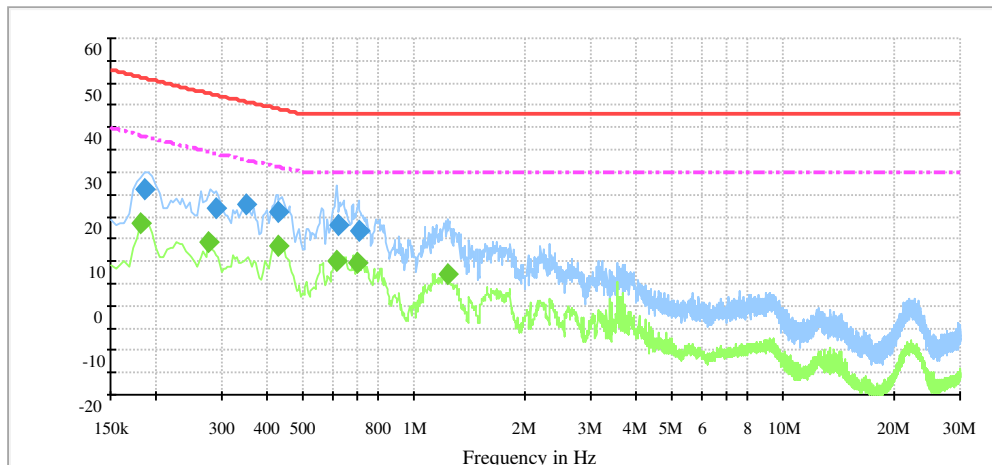



3.3 RADIATED EMISSION MEASUREMENT

3.3.1 LIMITS OF RADIATED EMISSION MEASUREMENT

Electromagnetic radiation disturbance limits for Class A:

Frequency range MHz	10 m measuring distance rated power of		3 m measuring distance ^b rated power of	
	≤ 20 kVA ^c	> 20 kVA ^{a, c}	≤ 20 kVA ^c	> 20 kVA ^{a, c}
	Quasi-peak dB(μV/m)	Quasi-peak dB(μV/m)	Quasi-peak dB(μV/m)	Quasi-peak dB(μV/m)
30 to 230	40	50	50	60
230 to 1 000	47	50	57	60

On a test site, class A equipment can be measured at a nominal distance of 3 m, 10 m or 30 m. A measuring distance less than 10 m is allowed only for equipment which complies with the definition given in 3.16. In case of measurements at a separation distance of 30 m, an inverse proportionality factor of 20 dB per decade shall be used to normalize the measured data to the specified distance for determining compliance.

At the transition frequency, the more stringent limit shall apply.

^a These limits apply to equipment with a rated power of > 20 kVA and intended to be used at locations where there is a distance greater than 30 m between the equipment and third party sensitive radio communications. The manufacturer shall indicate in the technical documentation that this equipment is intended to be used at locations where the separation distance to third party sensitive radio services is > 30 m. If these conditions are not met, then the limits for ≤ 20 kVA apply.

^b The 3 m separation distance applies only to small equipment meeting the size criterion defined in 3.16.

^c Selection of the appropriate set of limits shall be based on the rated AC power stated by the manufacturer.

Electromagnetic radiation disturbance limits for Class B:

Frequency range MHz	10 m measuring distance	3 m measuring distance ^a
	Quasi-peak dB(μV/m)	Quasi-peak dB(μV/m)
30 to 230	30	40
230 to 1 000	37	47

On a test site, class B equipment can be measured at a nominal distance of 3 m or 10 m.

At the transition frequency, the more stringent limit shall apply.

^a The 3 m separation distance applies only to small equipment meeting the size criterion defined in 3.16.



3.3.2 TEST INSTRUMENTS

Equipment	Manufacturer	Model No.	Serial No.	Last Cal.	Next Cal.
EMI Receiver	Agilent	N9038A	MY51210233	2018/10/22	2019/10/21
Spectrum Analyzer	Agilent	E4447A	MY52090002	2019/1/23	2020/1/22
Bilog antenna(30M-1G)	SCHWARZBECK	VULB 9163	548	2018/10/17	2019/10/16
Bilog antenna(30M-1G)	SCHWARZBECK	VULB 9163	549	2018/8/22	2019/8/21

Equipment	Manufacturer	Model No.	Serial No.	Last Cal.	Next Cal.
EMI Receiver	Agilent	N9038A	MY51210233	2020/04/27	2021/04/26
Spectrum Analyzer	Agilent	E4447A	MY52090002	2020/08/28	2021/08/27
Bilog antenna(30M-1G)	SCHWARZBECK	VULB 9163	548	2020/06/30	2021/06/29
Bilog antenna(30M-1G)	SCHWARZBECK	VULB 9163	549	2020/06/30	2021/06/29

Equipment	Manufacturer	Model No.	Serial No.	Last Cal.	Next Cal.
EMI Receiver	Agilent	N9038A	MY51210233	2021/12/07	2022/12/06
Spectrum Analyzer	Agilent	E4447A	MY52090002	2022/08/23	2023/08/22
Bilog antenna(30M-1G)	SCHWARZBECK	VULB 9163	481	2022/08/23	2023/08/22

Equipment	Manufacturer	Model No.	Serial No.	Last Cal.	Next Cal.
EMI Receiver	Agilent	N9038A	MY51210233	2022/11/18	2023/11/17
Spectrum Analyzer	Agilent	E4447A	MY52090002	2023/06/30	2024/06/29
Bilog antenna(30M-1G)	SCHWARZBECK	VULB 9163	481	2022/08/23	2023/08/22

- NOTE:** 1.The test was performed by witness in 10m chamber of Reliability Laboratory of Huawei Technologies Co., Ltd.
2. The test was performed in 10m Chamber.



3.3.3 TEST PROCEDURE

- a. The EUT was placed on the top of a rotating table 0.8 meters above the ground at a 10 meters Semi-anechoic chamber room. The table was rotated 360 degrees to determine the position of the highest radiation.
- b. The EUT was set 10 meters away from the interference-receiving antenna, which was mounted on the top of a variable-height antenna tower.
- c. The height of antenna is varied from one meter to four meters above the ground to determine the maximum value of the field strength. Both horizontal and vertical polarizations of the antenna are set to make the measurement.
- d. For each suspected emission, the EUT was arranged to its worst case and then the antenna was tuned to heights from 1 meter to 4 meters and the turn table was turned from 0 degrees to 360 degrees to find the maximum reading.
- e. The test-receiver system was set to quasi-peak detect function and specified bandwidth with maximum hold mode when the test frequency is below 1 GHz.

NOTE:

1. The resolution bandwidth of test receiver/spectrum analyzer is 120kHz for Quasi-peak detection (QP) at frequency below 1GHz.
2. Emission level(dBuV/m)=Raw Value(dBuV) + Correction Factor(dB/m)
3. Correction Factor(dB/m) = Antenna Factor (dB/m) + Cable Factor (dB) (if the raw value not contains the amplifier)
4. Correction Factor (dB/m) = Antenna Factor (dB/m) + Cable Factor (dB) – Amplifier Gain(dB) (if the raw value contains the amplifier)
5. Margin value = Emission level – Limit value.

3.3.4 DEVIATION FROM TEST STANDARD

No deviation



3.3.5 TEST SETUP

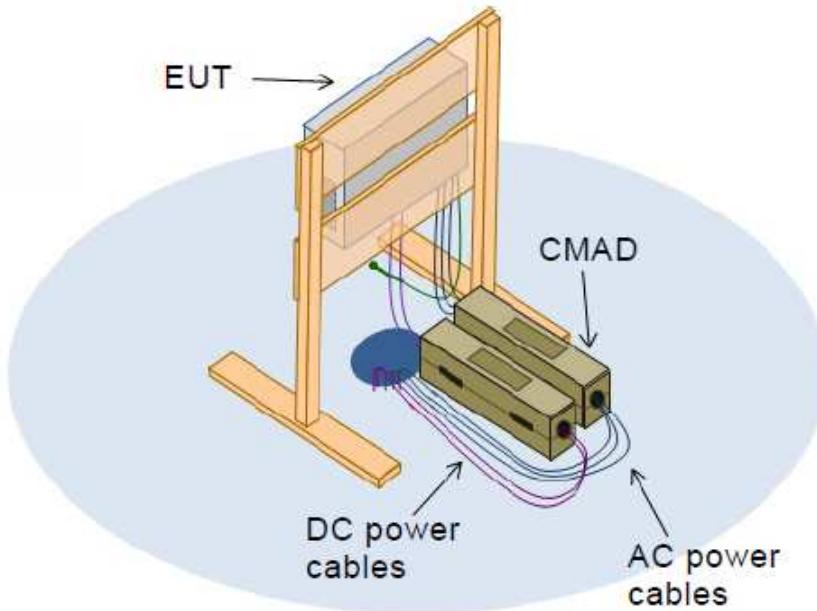
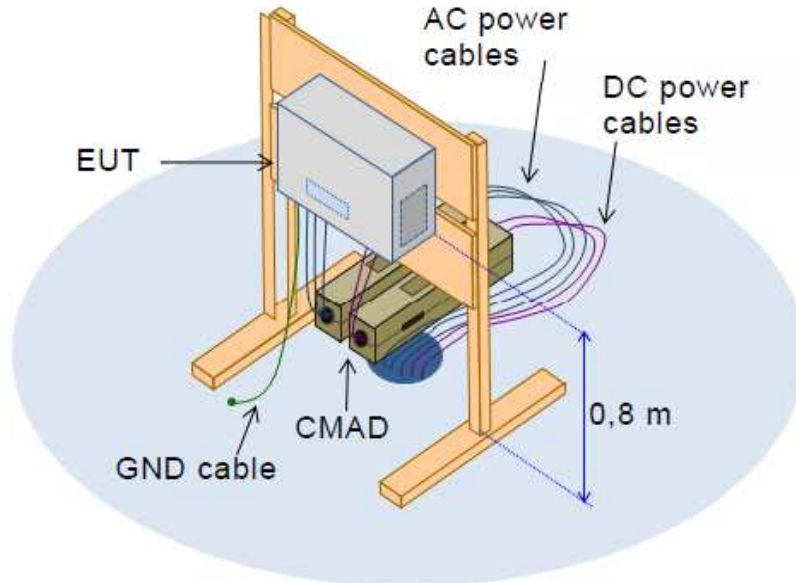

3.3.6 EUT OPERATING CONDITIONS

Same as item 3.1.6



3.3.7 TEST RESULTS

TEST MODE	SUN2000-100KTL-M1 Grid Mode(10% Load) + RS485 Data Acquisition	FREQUENCY RANGE	30-1000 MHz
TEST VOLTAGE	DC 1000V AC 400V	DETECTOR FUNCTION & BANDWIDTH	Quasi-Peak, 120kHz
ENVIRONMENTAL CONDITIONS	25 deg. C, 48% RH	TESTED BY: Wang Jia	

Frequency MHz	Level (dBuV/m) QP	Transd (dB)	Limit (dBuV/m) QP	Margin (d B) QP	Height cm	Angle deg	Polarization
45.965	25.4	-15.9	30.0	4.6	199.0	321.0	V
49.415	15.1	-15.7	30.0	14.9	130.0	177.0	H
56.556	18.5	-15.6	30.0	11.5	105.0	277.0	V
61.818	13.8	-16.6	30.0	16.2	199.0	198.0	H
64.938	19.6	-17.3	30.0	10.4	103.0	332.0	V
71.144	15.4	-19.5	30.0	14.6	199.0	183.0	H
74.385	19.8	-20.9	30.0	10.2	185.0	159.0	V
78.915	13.8	-22.2	30.0	16.2	200.0	167.0	H
83.803	20.0	-21.6	30.0	10.0	192.0	325.0	V
95.545	16.9	-18.0	30.0	13.1	148.0	261.0	V
95.942	12.6	-18.0	30.0	17.4	179.0	182.0	H
126.770	10.3	-20.2	30.0	19.7	169.0	155.0	H

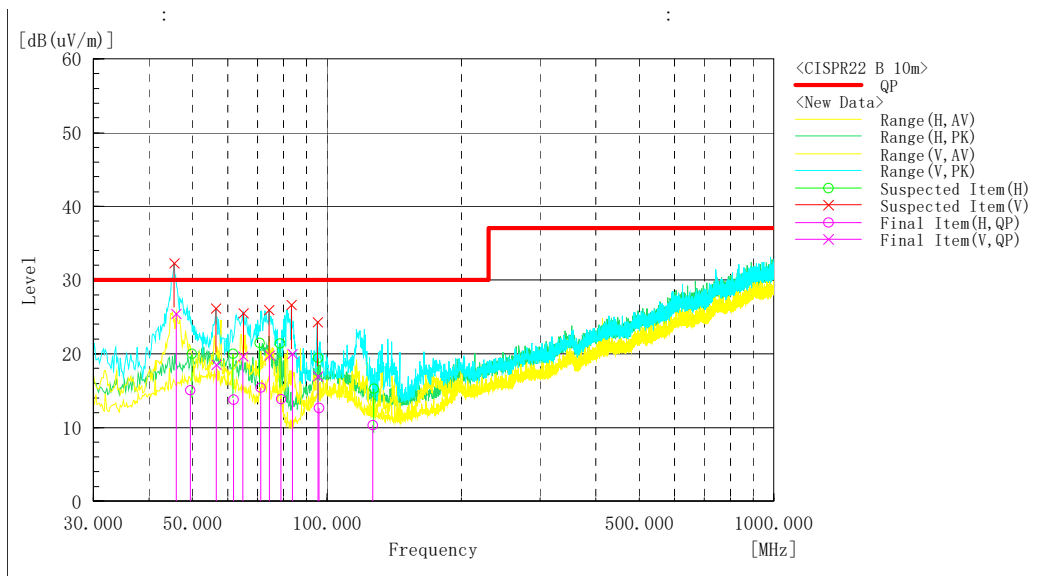



**BUREAU
VERITAS**

Test Report No.: CE2312WDG0186

TEST MODE	SUN2000-100KTL-M1 Grid Mode(Full Load) + RS485 Data Acquisition	FREQUENCY RANGE	30-1000 MHz
TEST VOLTAGE	DC 600V AC 480V	DETECTOR FUNCTION & BANDWIDTH	Quasi-Peak, 120kHz
ENVIRONMENTAL CONDITIONS	25 deg. C, 48% RH	TESTED BY: Wang Jia	

Frequency MHz	Level (dBuV/m) QP	Transd (dB)	Limit (dBuV/m) QP	Margin (d B) QP	Height cm	Angle deg	Polarization
54.599	21.3	-16.0	50.0	28.7	215.0	320.0	V
61.925	23.0	-16.6	50.0	27.0	103.0	282.0	V
59.364	16.1	-16.4	50.0	33.9	195.0	240.0	H
93.225	27.4	-18.0	50.0	22.6	121.0	325.0	V
153.380	21.2	-20.5	50.0	28.8	113.0	228.0	V
556.126	24.3	-8.4	50.0	25.7	103.0	173.0	V

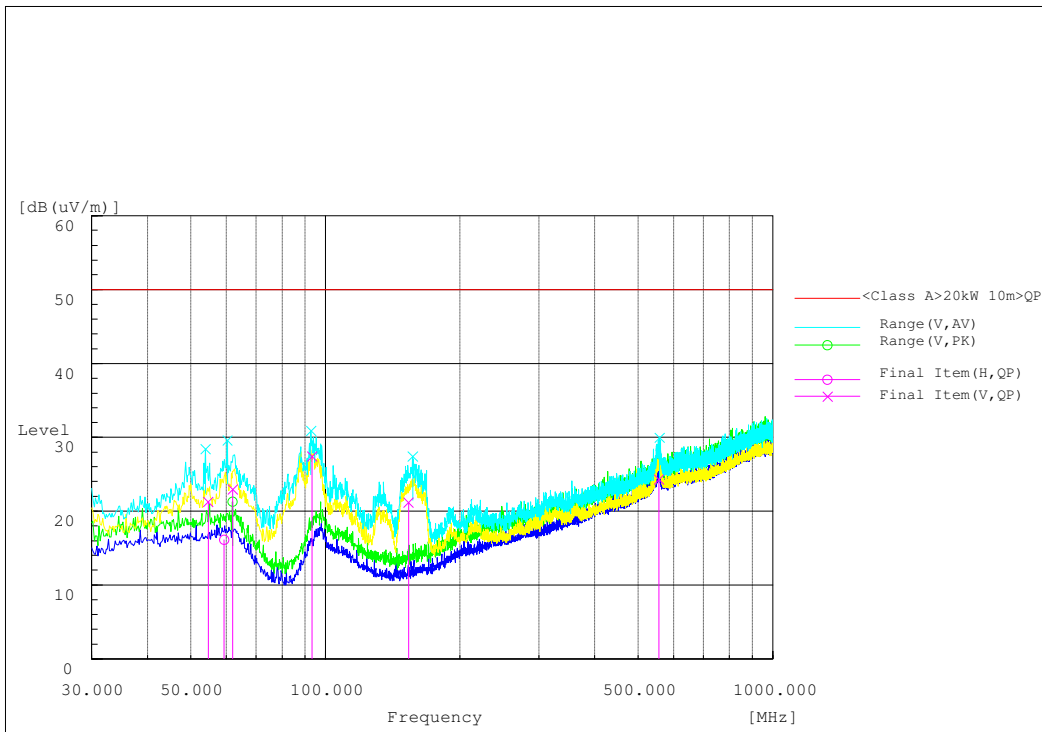

**Bureau Veritas Shenzhen Co., Ltd.
Dongguan Branch**

No. 96, Guantai Road (Houjie Section), Houjie
Town, Dongguan City, Guangdong Province.
523942, People's Republic of China

Tel: +86 769 8998 2098
Fax: +86 769 8593 1080
Email: customerservice.dg@bureauveritas.com



**BUREAU
VERITAS**

Test Report No.: CE2312WDG0186

TEST MODE	SUN2000-100KTL-M1 Grid Mode(Full Load) + MBUS Data Acquisition	FREQUENCY RANGE	30-1000 MHz
TEST VOLTAGE	DC 600V AC 400V	DETECTOR FUNCTION & BANDWIDTH	Quasi-Peak, 120kHz
ENVIRONMENTAL CONDITIONS	25 deg. C, 48% RH	TESTED BY: Wang Jia	

Frequency MHz	Level (dBuV/m) QP	Transd (dB)	Limit (dBuV/m) QP	Margin (d B) QP	Height cm	Angle deg	Polarization
62.417	41.3	-16.8	50.0	8.7	141.0	125.0	V
65.680	40.9	-17.6	50.0	9.1	103.0	119.0	V
46.203	39.4	-16.0	50.0	10.6	194.0	325.0	V
38.179	35.0	-17.6	50.0	15.0	127.0	264.0	V
31.113	32.5	-18.6	50.0	17.5	100.0	228.0	V
88.673	22.7	-19.9	50.0	27.3	216.0	282.0	V
62.592	27.6	-16.8	50.0	22.4	180.0	238.0	H
45.437	25.6	-16.1	50.0	24.4	215.0	104.0	H
47.301	26.1	-15.8	50.0	23.9	174.0	8.0	H
31.668	22.0	-18.5	50.0	28.0	215.0	0.0	H
68.443	27.1	-18.4	50.0	22.9	100.0	26.0	H
64.439	26.6	-17.3	50.0	23.4	103.0	31.0	H

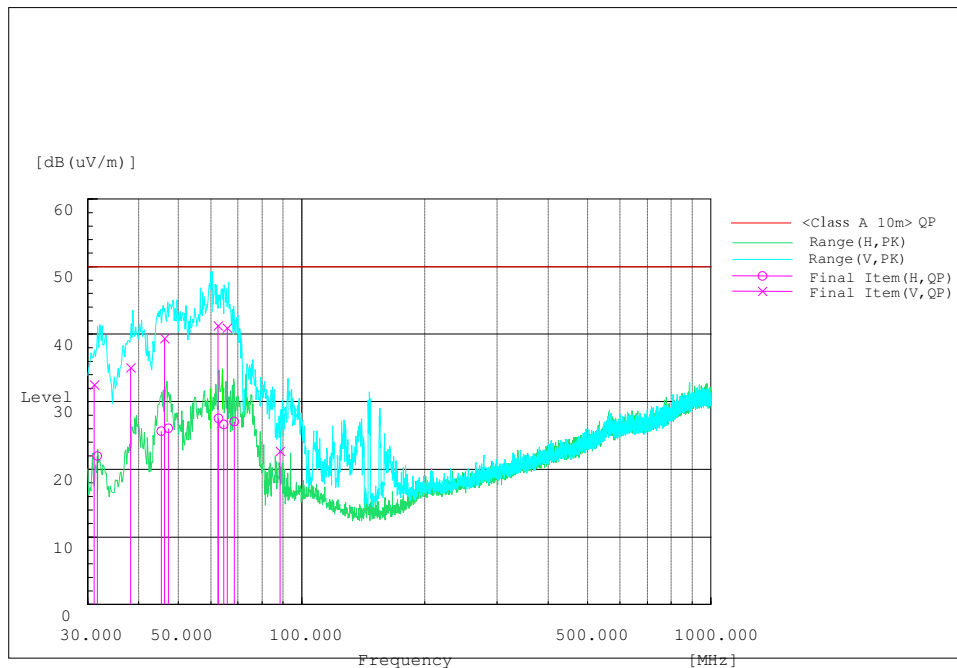

Bureau Veritas Shenzhen Co., Ltd.
Dongguan Branch

No. 96, Guantai Road (Houjie Section), Houjie
Town, Dongguan City, Guangdong Province.
523942. People's Republic of China

Tel: +86 769 8998 2098
Fax: +86 769 8593 1080
Email: customerservice.dg@bureauveritas.com



**BUREAU
VERITAS**

Test Report No.: CE2312WDG0186

TEST MODE	SUN2000-115KTL-M2 Grid Mode(10% Load) + RS485 Data Acquisition	FREQUENCY RANGE	30-1000 MHz
TEST VOLTAGE	DC 1000V AC 400V	DETECTOR FUNCTION & BANDWIDTH	Quasi-Peak, 120kHz
ENVIRONMENTAL CONDITIONS	25 deg. C, 48% RH	TESTED BY: Wang Jia	

Frequency MHz	Level (dBuV/m) QP	Transd (dB)	Limit (dBuV/m) QP	Margin (d B) QP	Height cm	Angle deg	Polarization
116.643	25.0	-18.7	30.0	5.0	100.0	8.0	V
105.291	21.8	-17.2	30.0	8.2	121.0	32.0	V
70.891	20.6	-19.4	30.0	9.4	196.0	203.0	V
73.537	22.7	-20.6	30.0	7.3	198.0	295.0	V
45.831	23.0	-15.9	30.0	7.0	100.0	0.0	V
126.499	17.7	-20.1	30.0	12.3	108.0	341.0	V
70.805	18.4	-19.4	30.0	11.6	200.0	201.0	H
73.386	17.2	-20.5	30.0	12.8	197.0	32.0	H
54.245	15.1	-15.6	30.0	14.9	196.0	11.0	H
103.967	14.1	-17.1	30.0	15.9	117.0	53.0	H
207.266	13.1	-17.3	30.0	16.9	186.0	240.0	H
44.458	14.4	-16.4	30.0	15.6	114.0	310.0	H

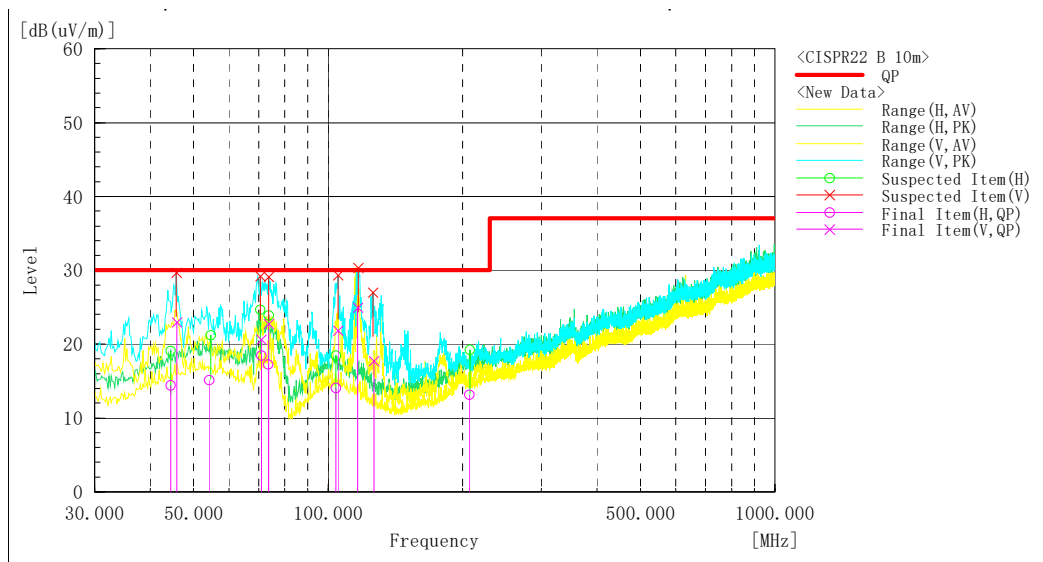

**Bureau Veritas Shenzhen Co., Ltd.
Dongguan Branch**

No. 96, Guantai Road (Houjie Section), Houjie
Town, Dongguan City, Guangdong Province.
523942. People's Republic of China

Tel: +86 769 8998 2098
Fax: +86 769 8593 1080
Email: customerservice.dg@bureauveritas.com



**BUREAU
VERITAS**

Test Report No.: CE2312WDG0186

TEST MODE	SUN2000-115KTL-M2 Grid Mode(Full Load) + MBUS Data Acquisition	FREQUENCY RANGE	30-1000 MHz
TEST VOLTAGE	DC 625V AC 480V	DETECTOR FUNCTION & BANDWIDTH	Quasi-Peak, 120kHz
ENVIRONMENTAL CONDITIONS	25 deg. C, 48% RH	TESTED BY: Wang Jia	

Frequency MHz	Level (dBuV/m) QP	Transd (dB)	Limit (dBuV/m) QP	Margin (d B) QP	Height cm	Angle deg	Polarization
30.050	23.8	-18.7	50.0	26.2	218.0	165.0	H
30.415	21.2	-18.6	50.0	28.8	218.0	197.0	H
51.072	22.8	-15.6	50.0	27.2	183.0	207.0	V
31.965	22.8	-18.4	50.0	27.2	100.0	167.0	V
30.154	32.5	-18.7	50.0	17.5	100.0	188.0	V
69.064	22.6	-18.7	50.0	27.4	218.0	282.0	V
35.599	18.9	-18.0	50.0	31.1	101.0	45.0	V
151.586	23.5	-20.5	50.0	26.5	104.0	338.0	V
42.928	17.4	-16.7	50.0	32.6	100.0	243.0	H
48.401	18.7	-15.7	50.0	31.3	101.0	9.0	H
69.640	19.1	-18.9	50.0	30.9	219.0	216.0	H
60.980	14.5	-16.5	50.0	35.5	218.0	45.0	H

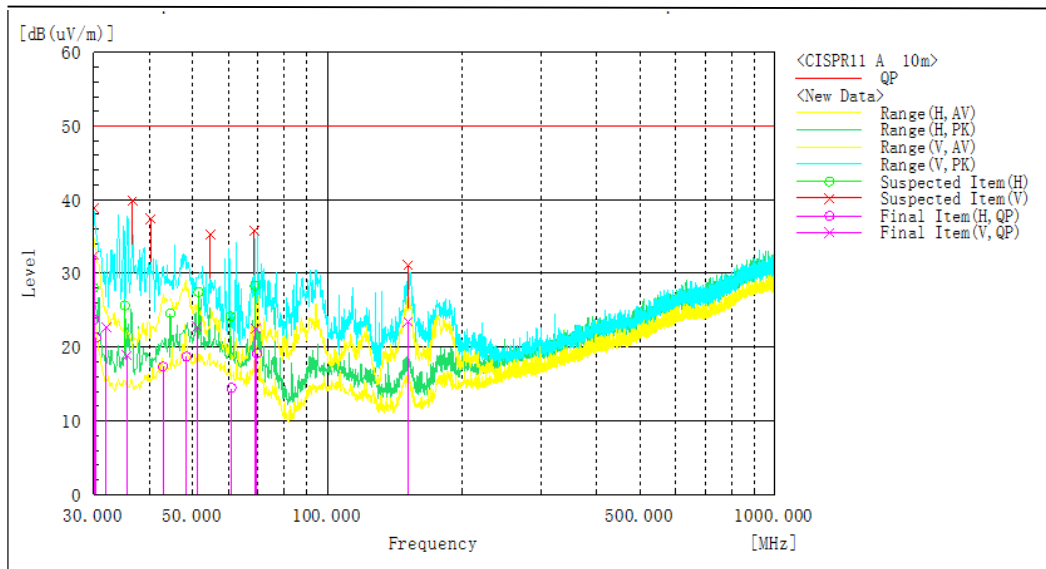

**Bureau Veritas Shenzhen Co., Ltd.
Dongguan Branch**

No. 96, Guantai Road (Houjie Section), Houjie
Town, Dongguan City, Guangdong Province.
523942. People's Republic of China

Tel: +86 769 8998 2098
Fax: +86 769 8593 1080
Email: customerservice.dg@bureauveritas.com



3.4 HARMONICS CURRENT MEASUREMENT (>16A)

3.4.1 TEST INSTRUMENTS

TEST STANDARD: EN 61000-3-12

Description	Manufacturer	Model no.	Serial No.	Last Cal.	Next Cal.
Power Analyzer	YOKOGAWA	WT3000	91J902079	2019/02/19	2020/02/18
Power Analyzer	HIOKI	PW6001	170200696	2019/02/21	2020/02/20
Programmable DC source	Keysight	N8957APV	DE16391780	2018/12/20	2019/12/19
Programmable DC source	Keysight	N8957APV	DE16391779	2018/12/20	2019/12/19
Programmable DC source	Keysight	N8957APV	DE16391778	2018/12/20	2019/12/19
Programmable DC source	Keysight	N8957APV	DE16321623	2018/12/20	2019/12/19
Programmable DC source	Keysight	N8957APV	DE16321622	2018/12/20	2019/12/19
Programmable DC source	Keysight	N8957APV	DE16341673	2018/12/20	2019/12/19
Programmable DC source	Keysight	N8957APV	DE16341669	2018/12/20	2019/12/19
Programmable DC source	Keysight	N8957APV	DE16341674	2018/12/20	2019/12/19
Programmable DC source	Keysight	N8957APV	DE16341675	2018/12/20	2019/12/19
Programmable DC source	Keysight	N8957APV	DE16341670	2018/12/20	2019/12/19
Programmable DC source	Keysight	N8957APV	DE16341672	2018/12/20	2019/12/19
Programmable DC source	Keysight	N8957APV	DE16321625	2018/12/20	2019/12/19
Programmable DC source	Keysight	N8957APV	DE16321626	2018/12/20	2019/12/19
Programmable DC source	Keysight	N8957APV	DE16321627	2018/12/20	2019/12/19
AC Source	Ametek	RS90-3PI	1515A00638	2019/04/07	2020/04/06
AC Source	Ametek	RS90-3PI	1623A00088	2018/12/20	2019/12/19
Oscillographic recorder	YOKOGAWA	DL850	91LA25621	2019/04/04	2020/04/03
Oscillographic recorder	Tektronix	DPO7054	C010429	2019/04/07	2020/04/06
Electric current transducer	HIOKI	CT6863	140201351	2019/02/24	2020/02/23



Electric current transducer	HIOKI	CT6863	140201344	2019/02/24	2020/02/23
Electric current transducer	HIOKI	CT6863	140201347	2019/02/24	2020/02/23

Description	Manufacturer	Model no.	Serial No.	Last Cal.	Next Cal.
Power analyzer	YOKOGAWA	WT3000	91J902079	2022/05/21	2023/05/20
Current sensor	HIOKI	CT9555/CT6863	170333301	2021/12/31	2022/12/3
Current sensor	HIOKI	CT9555/CT6862-05	170239123/170342413	2021/12/31	2022/12/30
Current sensor	HIOKI	CT9555/CT6863	170234315/160922604	2021/12/31	2022/12/30

NOTE: 1. The test was performed by witness in H/F Room of ShangHai Huawei Technology Co., Ltd.
 2. The test was performed in Harmonics Room.

3.4.2 CURRENT EMISSION LIMITS FOR EQUIPMENT OTHER THAN BALANCED THREE-PHASE EQUIPMENT

Minimal R_{sce}	Admissible individual harmonic current I_n/I_1 ^a %						Admissible harmonic current distortion factors %	
	I_3	I_5	I_7	I_9	I_{11}	I_{13}	<i>THD</i>	<i>PWHD</i>
33	21,6	10,7	7,2	3,8	3,1	2	23	23
66	24	13	8	5	4	3	26	26
120	27	15	10	6	5	4	30	30
250	35	20	13	9	8	6	40	40
≥ 350	41	24	15	12	10	8	47	47

The relative values of even harmonics up to order 12 shall not exceed $16/n$ %. Even harmonics above order 12 are taken into account in *THD* and *PWHD* in the same way as odd order harmonics.

NOTE Linear interpolation between successive R_{sce} values is permitted. See also Annex B.

^a I_1 = reference fundamental current; I_n = harmonic current component.



3.4.3 CURRENT EMISSION LIMITS FOR BALANCED THREE-PHASE EQUIPMENT

Minimal R_{sce}	Admissible individual harmonic current I_n/I_1^a %				Admissible harmonic current distortion factors %	
	I_5	I_7	I_{11}	I_{13}	<i>THD</i>	<i>PWHD</i>
33	10,7	7,2	3,1	2	13	22
66	14	9	5	3	16	25
120	19	12	7	4	22	28
250	31	20	12	7	37	38
≥ 350	40	25	15	10	48	46

The relative values of even harmonics up to order 12 shall not exceed 16/n %. Even harmonics above order 12 are taken into account in *THD* and *PWHD* in the same way as odd order harmonics.

NOTE Linear interpolation between successive R_{sce} values is permitted. See also Annex B.

^a I_1 = reference fundamental current; I_n = harmonic current component.

3.4.4 CURRENT EMISSION LIMITS FOR BALANCED THREE-PHASE EQUIPMENT UNDER SPECIFIED CONDITIONS

Minimal R_{sce}	Admissible individual harmonic current I_n/I_1^a %				Admissible harmonic current distortion factors %	
	I_5	I_7	I_{11}	I_{13}	<i>THD</i>	<i>PWHD</i>
33	10,7	7,2	3,1	2	13	22
≥ 120	40	25	15	10	48	46

The relative values of even harmonics up to order 12 shall not exceed 16/n %. Even harmonics above order 12 are taken into account in *THD* and *PWHD* in the same way as odd order harmonics.

NOTE Linear interpolation between successive R_{sce} values is permitted. See also Annex B.

^a I_1 = reference fundamental current; I_n = harmonic current component.

3.4.5 DEVIATION FROM TEST STANDARD

No deviation



3.4.6 TEST SETUP

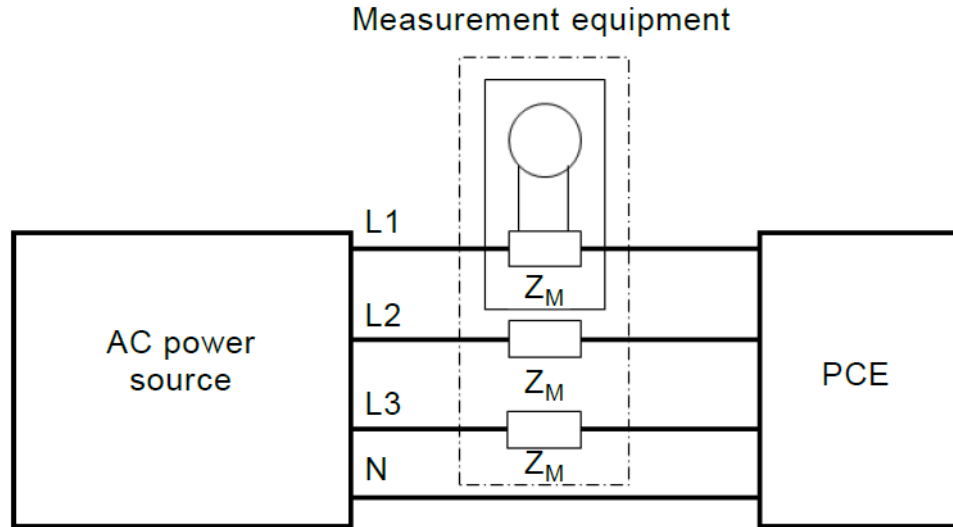

IEC

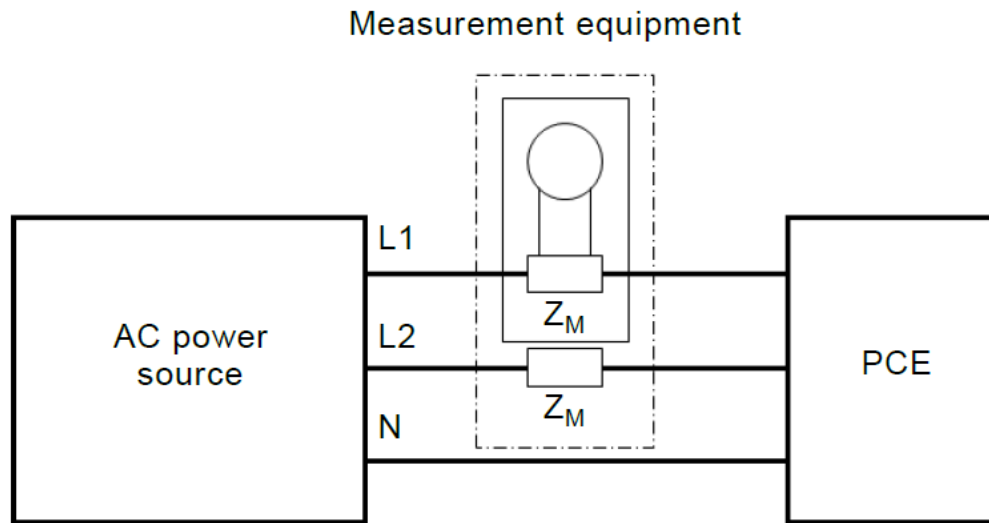

IEC

3.4.7 EUT OPERATING CONDITIONS

Same as item 3.1.6

Bureau Veritas Shenzhen Co., Ltd.
Dongguan Branch

No. 96, Guantai Road (Houjie Section), Houjie
Town, Dongguan City, Guangdong Province.
523942, People's Republic of China

Tel: +86 769 8998 2098
Fax: +86 769 8593 1080
Email: customerservice.dg@bureauveritas.com



BUREAU VERITAS

Test Report No.: CE2312WDG0186

3.4.8 TEST RESULTS

SUN2000-100KTL-M1 AC 400V 10% Load:

Regulation : IEC61000-3-12 Ed2.0
 IEC61000-4-7 Ed2.0 A1
 MeasureTime : 150sec
 Model : YOKOGAWA WT3000
 Wiring : 3P4W(3P:three-phase)
 Element : 1
 Range : 300V/200.0A
 Rating Voltage : 400 V
 I_{equ} : 144.4000 A
 Z Impedance : 0.0400 ohm
 I_{ref} : 14.6964 A
 Set I_{ref} : -----
 Power R_{sce} : 391.831
 Max R_{sce} : 33.000

PASS

Ssc : 336880.32
 Min R_{sce} : 33.0000
 Apply Limit : Table2-Other than balanced 3-phase
 Circumstance a : 0.42% (Pass)
 Term a(I5) : 0.51% (Pass)
 Term a(I7) : 0.65% (Pass)
 Term c : 181.14 - 355.29deg (Fail)
 Term d(I5) : 0.51% (Pass)
 Term d(I7) : 0.65% (Pass)
 Term f : 181.14 - 355.29deg (Fail)

[Average]
 Voltage(rms) : 230.30 V
 Current(rms) : 14.70 A
 Frequency : 50.00 Hz
 Power Factor : 1.00
 Sigma W : 10140.27 W
 THC : 0.25 A
 V THD : 0.10 %
 A THD : 1.73 %
 P THD : 0.00 %

[Maximum]
 Voltage(rms) : 230.31 V
 Current(rms) : 14.71 A
 Frequency : 50.05 Hz
 Power Factor : 1.00
 Sigma W : 10153.37 W
 THC : 0.27 A
 V THD : 0.11 %
 A THD : 2.61 %
 P THD : 0.00 %

Order	Measure[%]	Limit[%]	Margin[%]
2	0.3730	8.0000	95.3
3	0.2973	21.6000	98.6
4	0.3154	4.0000	92.1
5	0.4101	10.7000	96.2
6	0.1811	2.6667	93.2
7	0.5731	7.2000	92.0
8	0.1753	2.0000	91.2
9	0.2156	3.8000	94.3
10	0.1684	1.6000	89.5
11	0.2491	3.1000	92.0
12	0.1641	1.3333	87.7
13	0.2808	2.0000	86.0
TH	0.0000	23.0000	100.0
PWH	0.0000	23.0000	100.0

Order	Measure[%]	Limit[%]	Margin[%]
2	0.4939	12.0000	95.9
3	0.4205	32.4000	98.7
4	0.4107	6.0000	93.2
5	0.5148	16.0500	96.8
6	0.2169	4.0000	94.6
7	0.6494	10.8000	94.0
8	0.2182	3.0000	92.7
9	0.2426	5.7000	95.7
10	0.2014	2.4000	91.6
11	0.2880	4.6500	93.8
12	0.1890	2.0000	90.6
13	0.3256	3.0000	89.1
TH	0.0000	34.5000	100.0
PWH	0.0000	34.5000	100.0

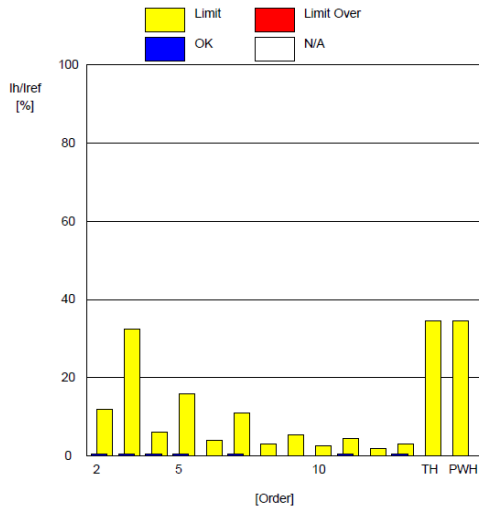
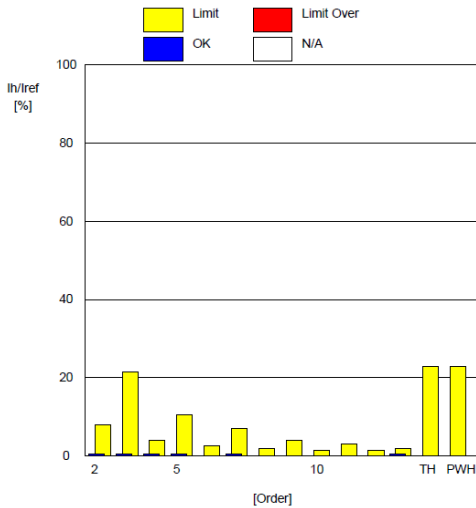

Bureau Veritas Shenzhen Co., Ltd.
Dongguan Branch

No. 96, Guantai Road (Houjie Section), Houjie
Town, Dongguan City, Guangdong Province.
523942. People's Republic of China

Tel: +86 769 8998 2098
Fax: +86 769 8593 1080
Email: customerservice.dg@bureauveritas.com



Regulation : IEC61000-3-12 Ed2.0
 IEC61000-4-7 Ed2.0 A1
 MeasureTime : 150sec
 Model : YOKOGAWA WT3000
 Wiring : 3P4W(3P:three-phase)
 Element : 2
 Range : 300V/200.0A
 Rating Voltage : 400 V
 I_{equ} : 144.4000 A
 Z Impedance : 0.0400 ohm
 I_{ref} : 14.6433 A
 Set I_{ref} : -----
 Power R_{sce} : 391.831
 Max R_{sce} : 33.000

PASS

Ssc : 336880.32
 Min R_{sce} : 33.0000
 Apply Limit : Table2-Other than balanced 3-phase
 Circumstance a : 0.51% (Pass)
 Term a(I5) : 0.45% (Pass)
 Term a(I7) : 0.57% (Pass)
 Term c : 0.69 - 359.97deg (Fail)
 Term d(I5) : 0.45% (Pass)
 Term d(I7) : 0.57% (Pass)
 Term f : 0.69 - 359.97deg (Fail)

[Average]
 Voltage(rms) : 230.26 V
 Current(rms) : 14.64 A
 Frequency : 50.00 Hz
 Power Factor : 1.00
 Sigma W : 10140.27 W
 THC : 0.24 A
 V THD : 0.11 %
 A THD : 1.67 %
 P THD : 0.00 %

[Maximum]
 Voltage(rms) : 230.27 V
 Current(rms) : 14.66 A
 Frequency : 50.05 Hz
 Power Factor : 1.00
 Sigma W : 10153.37 W
 THC : 0.27 A
 V THD : 0.12 %
 A THD : 2.49 %
 P THD : 0.00 %

Order	Measure[%]	Limit[%]	Margin[%]
2	0.4140	8.0000	94.8
3	0.3994	21.6000	98.2
4	0.3691	4.0000	90.8
5	0.3114	10.7000	97.1
6	0.1902	2.6667	92.9
7	0.5006	7.2000	93.0
8	0.1712	2.0000	91.4
9	0.1882	3.8000	95.1
10	0.1636	1.6000	89.8
11	0.2548	3.1000	91.8
12	0.1679	1.3333	87.4
13	0.2621	2.0000	86.9
TH	0.0000	23.0000	100.0
PWH	0.0000	23.0000	100.0

Order	Measure[%]	Limit[%]	Margin[%]
2	0.5199	12.0000	95.7
3	0.5057	32.4000	98.4
4	0.5412	6.0000	91.0
5	0.4518	16.0500	97.2
6	0.2297	4.0000	94.3
7	0.5712	10.8000	94.7
8	0.1971	3.0000	93.4
9	0.2158	5.7000	96.2
10	0.1907	2.4000	92.1
11	0.2878	4.6500	93.8
12	0.1955	2.0000	90.2
13	0.3461	3.0000	88.5
TH	0.0000	34.5000	100.0
PWH	0.0000	34.5000	100.0

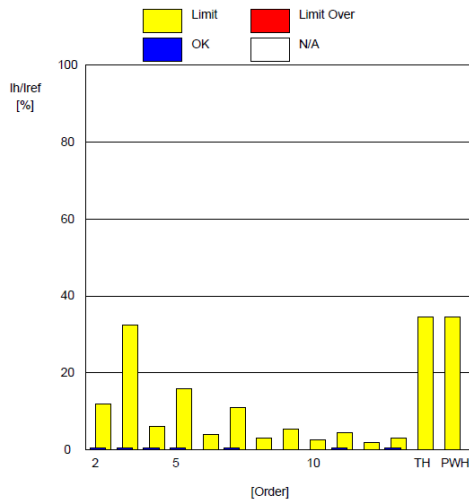
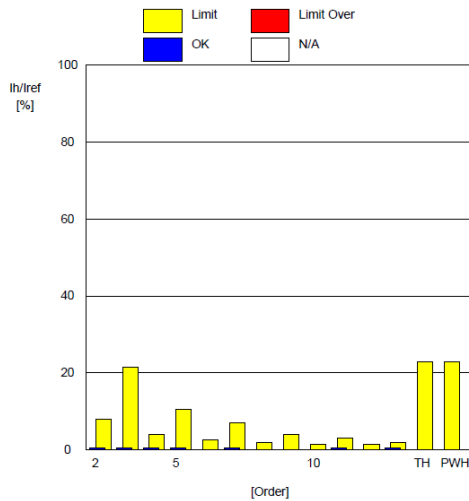



Regulation : IEC61000-3-12 Ed2.0
 IEC61000-4-7 Ed2.0 A1
 MeasureTime : 150sec
 Model : YOKOGAWA WT3000
 Wiring : 3P4W(3P.three-phase)
 Element : 3
 Range : 300V/200.0A
 Rating Voltage : 400 V
 I_{equ} : 144.4000 A
 Z Impedance : 0.0400 ohm
 I_{ref} : 14.7168 A
 Set I_{ref} : -----
 Power Rsce : 391.831
 Max Rsce : 33.000

PASS

Ssc : 336880.32
 Min Rsce : 33.0000
 Apply Limit : Table2-Other than balanced 3-phase
 Circumstance a : 0.72% (Pass)
 Term a(I5) : 0.53% (Pass)
 Term a(I7) : 0.54% (Pass)
 Term c : 0.03 - 359.77deg (Fail)
 Term d(I5) : 0.53% (Pass)
 Term d(I7) : 0.54% (Pass)
 Term f : 0.03 - 359.77deg (Fail)

[Average]
 Voltage(rms) : 230.08 V
 Current(rms) : 14.72 A
 Frequency : 50.00 Hz
 Power Factor : 1.00
 Sigma W : 10140.27 W
 THC : 0.25 A
 V THD : 0.09 %
 A THD : 1.72 %
 P THD : 0.00 %

[Maximum]
 Voltage(rms) : 230.09 V
 Current(rms) : 14.73 A
 Frequency : 50.05 Hz
 Power Factor : 1.00
 Sigma W : 10153.37 W
 THC : 0.28 A
 V THD : 0.10 %
 A THD : 2.55 %
 P THD : 0.00 %

Order	Measure[%]	Limit[%]	Margin[%]
2	0.4611	8.0000	94.2
3	0.6353	21.6000	97.1
4	0.3189	4.0000	92.0
5	0.3360	10.7000	96.9
6	0.1816	2.6667	93.2
7	0.4671	7.2000	93.5
8	0.1690	2.0000	91.6
9	0.1788	3.8000	95.3
10	0.1681	1.6000	89.5
11	0.2305	3.1000	92.6
12	0.1635	1.3333	87.7
13	0.2750	2.0000	86.3
TH	0.0000	23.0000	100.0
PWH	0.0000	23.0000	100.0

Order	Measure[%]	Limit[%]	Margin[%]
2	0.6053	12.0000	95.0
3	0.7151	32.4000	97.8
4	0.4637	6.0000	92.3
5	0.5318	16.0500	96.7
6	0.2260	4.0000	94.4
7	0.5373	10.8000	95.0
8	0.2071	3.0000	93.1
9	0.2086	5.7000	96.3
10	0.1971	2.4000	91.8
11	0.2765	4.6500	94.1
12	0.1913	2.0000	90.4
13	0.3730	3.0000	87.6
TH	0.0000	34.5000	100.0
PWH	0.0000	34.5000	100.0

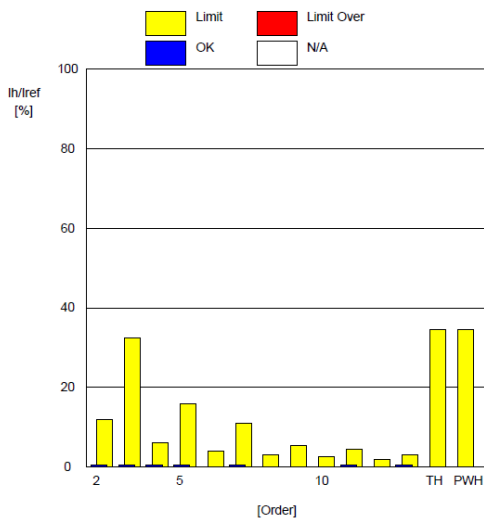
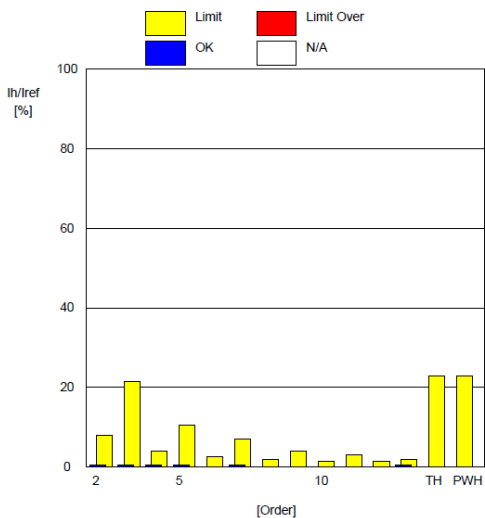



BUREAU VERITAS

Test Report No.: CE2312WDG0186

AC 400V 50% Load

Regulation : IEC61000-3-12 Ed2.0
 IEC61000-4-7 Ed2.0 A1
 MeasureTime : 150sec
 Model : YOKOGAWA WT3000
 Wiring : 3P4W(3P:three-phase)
 Element : 1
 Range : 300V/200.0A
 Rating Voltage : 400 V
 I_{equ} : 144.4000 A
 Z Impedance : 0.0400 ohm
 I_{ref} : 73.0341 A
 Set I_{ref} : -----
 Power Rsce : 79.011
 Max Rsce : 33.000

PASS

Ssc : 1670646.60
 Min Rsce : 33.0000
 Apply Limit : Table2-Other than balanced 3-phase
 Circumstance a : 0.24% (Pass)
 Term a(I5) : 0.54% (Pass)
 Term a(I7) : 0.27% (Pass)
 Term c : 7.21 - 25.71deg (Fail)
 Term d(I5) : 0.54% (Pass)
 Term d(I7) : 0.27% (Pass)
 Term f : 7.21 - 25.71deg (Fail)

[Average]
 Voltage(rms) : 230.41 V
 Current(rms) : 73.03 A
 Frequency : 50.00 Hz
 Power Factor : 1.00
 Sigma W : 50388.22 W
 THC : 0.62 A
 V THD : 0.55 %
 A THD : 0.86 %
 P THD : 0.00 %

[Maximum]
 Voltage(rms) : 230.43 V
 Current(rms) : 73.07 A
 Frequency : 50.06 Hz
 Power Factor : 1.00
 Sigma W : 50416.48 W
 THC : 0.68 A
 V THD : 0.57 %
 A THD : 0.98 %
 P THD : 0.00 %

Order	Measure[%]	Limit[%]	Margin[%]
2	0.1196	8.0000	98.5
3	0.2038	21.6000	99.1
4	0.0689	4.0000	98.3
5	0.4513	10.7000	95.8
6	0.0428	2.6667	98.4
7	0.2260	7.2000	96.9
8	0.0422	2.0000	97.9
9	0.0843	3.8000	97.8
10	0.0387	1.6000	97.6
11	0.1698	3.1000	94.5
12	0.0374	1.3333	97.2
13	0.1927	2.0000	90.4
TH	0.0000	23.0000	100.0
PWH	0.0000	23.0000	100.0

Order	Measure[%]	Limit[%]	Margin[%]
2	0.1357	12.0000	98.9
3	0.2355	32.4000	99.3
4	0.0880	6.0000	98.5
5	0.5420	16.0500	96.6
6	0.0510	4.0000	98.7
7	0.2715	10.8000	97.5
8	0.0510	3.0000	98.3
9	0.1059	5.7000	98.1
10	0.0438	2.4000	98.2
11	0.2663	4.6500	94.3
12	0.0417	2.0000	97.9
13	0.2145	3.0000	92.9
TH	0.0000	34.5000	100.0
PWH	0.0000	34.5000	100.0

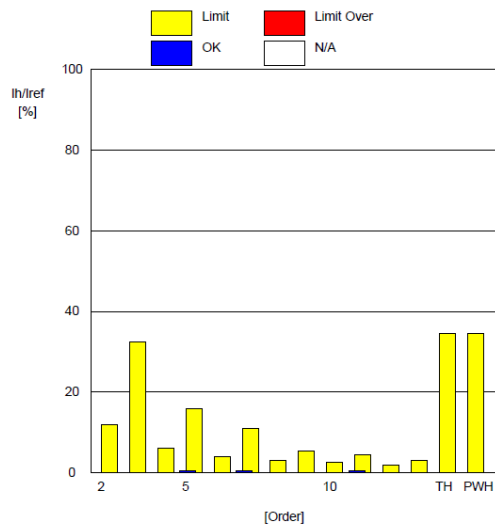
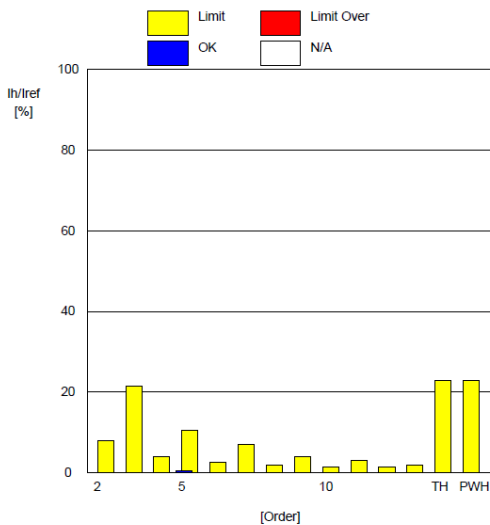

Bureau Veritas Shenzhen Co., Ltd. Dongguan Branch

No. 96, Guantai Road (Houjie Section), Houjie Town, Dongguan City, Guangdong Province. 523942. People's Republic of China

Tel: +86 769 8998 2098 Fax: +86 769 8593 1080 Email: customerservice.dg@bureauveritas.com



BUREAU VERITAS

Test Report No.: CE2312WDG0186

Regulation : IEC61000-3-12 Ed2.0
 IEC61000-4-7 Ed2.0 A1
 MeasureTime : 150sec
 Model : YOKOGAWA WT3000
 Wiring : 3P4W(3P.three-phase)
 Element : 2
 Range : 300V/200.0A
 Rating Voltage : 400 V
 I_{eq} : 144.4000 A
 Z Impedance : 0.0400 ohm
 I_{ref} : 72.7591 A
 Set I_{ref} : -----
 Power Rsce : 79.011
 Max Rsce : 33.000

PASS

Ssc : 1670646.60
 Min Rsce : 33.0000
 Apply Limit : Table2-Other than balanced 3-phase
 Circumstance a : 0.15% (Pass)
 Term a(I5) : 0.36% (Pass)
 Term a(I7) : 0.23% (Pass)
 Term c : 0.00 - 359.96deg (Fail)
 Term d(I5) : 0.36% (Pass)
 Term d(I7) : 0.23% (Pass)
 Term f : 0.00 - 359.96deg (Fail)

[Average]
 Voltage(rms) : 230.38 V
 Current(rms) : 72.76 A
 Frequency : 50.00 Hz
 Power Factor : 1.00
 Sigma W : 50388.22 W
 THC : 0.58 A
 V THD : 0.55 %
 A THD : 0.80 %
 P THD : 0.00 %

[Maximum]
 Voltage(rms) : 230.39 V
 Current(rms) : 72.80 A
 Frequency : 50.06 Hz
 Power Factor : 1.00
 Sigma W : 50416.48 W
 THC : 0.63 A
 V THD : 0.57 %
 A THD : 0.97 %
 P THD : 0.00 %

Order	Measure[%]	Limit[%]	Margin[%]
2	0.1529	8.0000	98.1
3	0.1157	21.6000	99.5
4	0.0919	4.0000	97.7
5	0.3088	10.7000	97.1
6	0.0405	2.6667	98.5
7	0.1857	7.2000	97.4
8	0.0406	2.0000	98.0
9	0.1374	3.8000	96.4
10	0.0371	1.6000	97.7
11	0.1685	3.1000	94.5
12	0.0387	1.3333	97.1
13	0.1556	2.0000	92.2
TH	0.0000	23.0000	100.0
PWH	0.0000	23.0000	100.0

Order	Measure[%]	Limit[%]	Margin[%]
2	0.1765	12.0000	98.5
3	0.1487	32.4000	99.5
4	0.1147	6.0000	98.1
5	0.3576	16.0500	97.8
6	0.0485	4.0000	98.8
7	0.2337	10.8000	97.8
8	0.0480	3.0000	98.4
9	0.1554	5.7000	97.3
10	0.0432	2.4000	98.2
11	0.2331	4.6500	95.0
12	0.0448	2.0000	97.8
13	0.1701	3.0000	94.3
TH	0.0000	34.5000	100.0
PWH	0.0000	34.5000	100.0

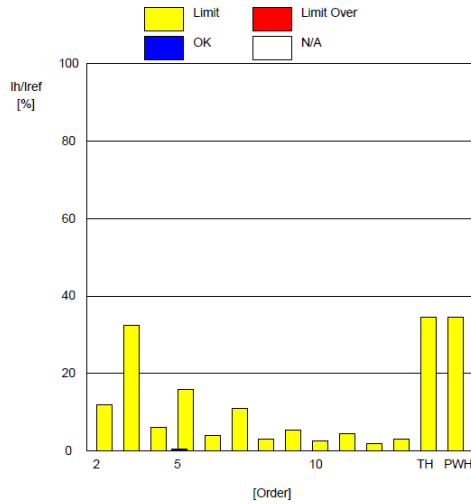
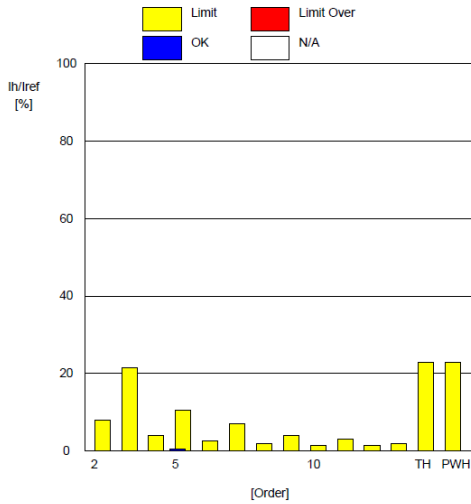

Bureau Veritas Shenzhen Co., Ltd.
Dongguan Branch

No. 96, Guantai Road (Houjie Section), Houjie
 Town, Dongguan City, Guangdong Province.
 523942. People's Republic of China

Tel: +86 769 8998 2098
 Fax: +86 769 8593 1080
 Email: customerservice.dg@bureauveritas.com



BUREAU VERITAS

Test Report No.: CE2312WDG0186

Regulation : IEC61000-3-12 Ed2.0
 IEC61000-4-7 Ed2.0 A1
 MeasureTime : 150sec
 Model : YOKOGAWA WT3000
 Wiring : 3P4W(3P.three-phase)
 Element : 3
 Range : 300V/200.0A
 Rating Voltage : 400 V
 I_{eq} : 144.4000 A
 Z Impedance : 0.0400 ohm
 I_{ref} : 72.9853 A
 Set I_{ref} : -----
 Power R_{sce} : 79.011
 Max R_{sce} : 33.000

PASS

Ssc : 1670646.60
 Min R_{sce} : 33.0000
 Apply Limit : Table2-Other than balanced 3-phase
 Circumstance a : 0.19% (Pass)
 Term a(I5) : 0.36% (Pass)
 Term a(I7) : 0.26% (Pass)
 Term c : 17.70 - 49.69deg (Fail)
 Term d(I5) : 0.36% (Pass)
 Term d(I7) : 0.26% (Pass)
 Term f : 17.70 - 49.69deg (Fail)

[Average]
 Voltage(rms) : 230.19 V
 Current(rms) : 72.99 A
 Frequency : 50.00 Hz
 Power Factor : 1.00
 Sigma W : 50388.22 W
 THC : 0.55 A
 V THD : 0.54 %
 A THD : 0.76 %
 P THD : 0.00 %

[Maximum]
 Voltage(rms) : 230.20 V
 Current(rms) : 73.03 A
 Frequency : 50.06 Hz
 Power Factor : 1.00
 Sigma W : 50416.48 W
 THC : 0.62 A
 V THD : 0.55 %
 A THD : 0.95 %
 P THD : 0.00 %

Order	Measure[%]	Limit[%]	Margin[%]
2	0.1711	8.0000	97.9
3	0.1531	21.6000	99.3
4	0.0741	4.0000	98.1
5	0.3138	10.7000	97.1
6	0.0445	2.6667	98.3
7	0.2058	7.2000	97.1
8	0.0386	2.0000	98.1
9	0.0965	3.8000	97.5
10	0.0396	1.6000	97.5
11	0.2120	3.1000	93.2
12	0.0367	1.3333	97.3
13	0.1224	2.0000	93.9
TH	0.0000	23.0000	100.0
PWH	0.0000	23.0000	100.0

Order	Measure[%]	Limit[%]	Margin[%]
2	0.1862	12.0000	98.4
3	0.1870	32.4000	99.4
4	0.0917	6.0000	98.5
5	0.3577	16.0500	97.8
6	0.0532	4.0000	98.7
7	0.2611	10.8000	97.6
8	0.0478	3.0000	98.4
9	0.1163	5.7000	98.0
10	0.0484	2.4000	98.0
11	0.2804	4.6500	94.0
12	0.0440	2.0000	97.8
13	0.1635	3.0000	94.6
TH	0.0000	34.5000	100.0
PWH	0.0000	34.5000	100.0

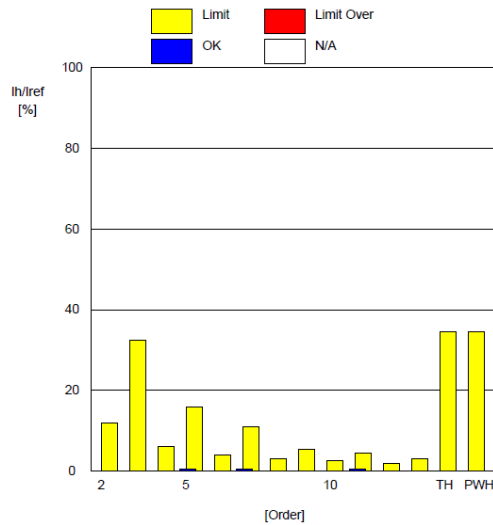
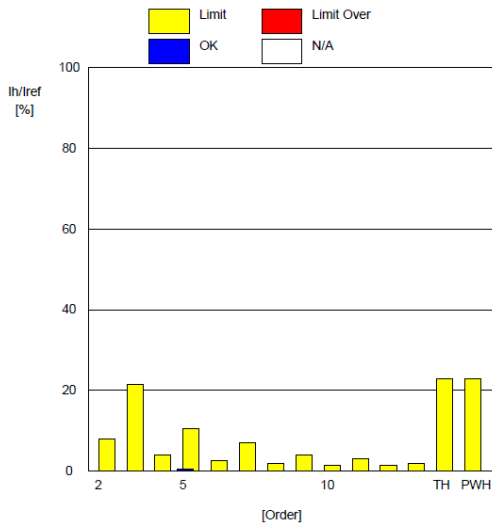

Bureau Veritas Shenzhen Co., Ltd.
Dongguan Branch

No. 96, Guantai Road (Houjie Section), Houjie
Town, Dongguan City, Guangdong Province.
523942. People's Republic of China

Tel: +86 769 8998 2098
Fax: +86 769 8593 1080
Email: customerservice.dg@bureauveritas.com



AC 400V Full Load:

Regulation : IEC61000-3-12 Ed2.0
IEC61000-4-7 Ed2.0 A1
MeasureTime : 150sec
Model : YOKOGAWA WT3000
Wiring : 3P4W(3P:three-phase)
Element : 1
Range : 300V/200.0A
Rating Voltage : 400 V
Ieq : 144.4000 A
Z Impedance : 0.0400 ohm
Iref : 144.8108 A
Set Iref :
Power Rsce : 39.832
Max Rsce : 33.000

PASS

Ssc : 3313954.23
Min Rsce : 33.0000
Apply Limit : Table2-Other than balanced 3-phase
Circumstance a : 0.22% (Pass)
Term a(I5) : 0.29% (Pass)
Term a(I7) : 0.19% (Pass)
Term c : 13.35 - 29.39deg (Fail)
Term d(I5) : 0.29% (Pass)
Term d(I7) : 0.19% (Pass)
Term f : 13.35 - 29.39deg (Fail)

[Average]
Voltage(rms) : 230.55 V
Current(rms) : 144.81 A
Frequency : 50.00 Hz
Power Factor : 1.00
Sigma W : 100052.8 W
THC : 0.96 A
V THD : 0.58 %
A THD : 0.67 %
P THD : 0.00 %

[Maximum]
Voltage(rms) : 230.56 V
Current(rms) : 144.88 A
Frequency : 50.20 Hz
Power Factor : 1.00
Sigma W : 100099.2 W
THC : 0.98 A
V THD : 0.59 %
A THD : 0.72 %
P THD : 0.00 %

Table with 4 columns: Order, Measure[%], Limit[%], Margin[%]. Contains 14 rows of test data.

Table with 4 columns: Order, Measure[%], Limit[%], Margin[%]. Contains 14 rows of test data.

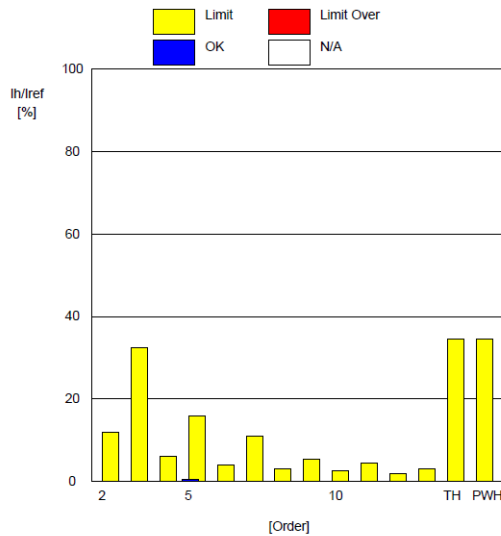
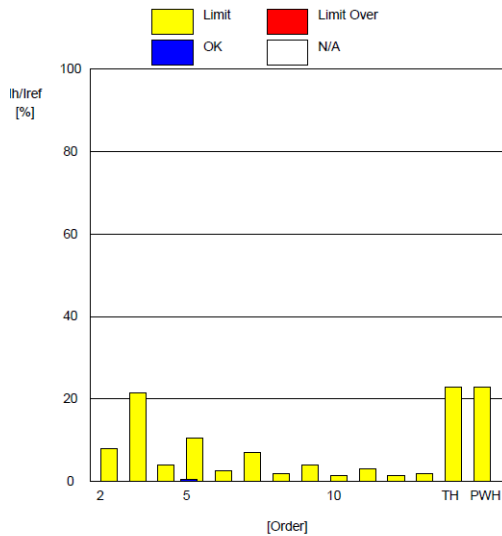



BUREAU VERITAS

Test Report No.: CE2312WDG0186

Regulation : IEC61000-3-12 Ed2.0
 IEC61000-4-7 Ed2.0 A1
 MeasureTime : 150sec
 Model : YOKOGAWA WT3000
 Wiring : 3P4W(3P:three-phase)
 Element : 2
 Range : 300V/200.0A
 Rating Voltage : 400 V
 I_{equ} : 144.4000 A
 Z Impedance : 0.0400 ohm
 I_{ref} : 144.4588 A
 Set I_{ref} : -----
 Power Rsce : 39.832
 Max Rsce : 33.000

PASS

Ssc : 3313954.23
 Min Rsce : 33.0000
 Apply Limit : Table2-Other than balanced 3-phase
 Circumstance a : 0.15% (Pass)
 Term a(I5) : 0.19% (Pass)
 Term a(I7) : 0.25% (Pass)
 Term c : 0.00 - 359.97deg (Fail)
 Term d(I5) : 0.19% (Pass)
 Term d(I7) : 0.25% (Pass)
 Term f : 0.00 - 359.97deg (Fail)

[Average]
 Voltage(rms) : 230.53 V
 Current(rms) : 144.46 A
 Frequency : 50.00 Hz
 Power Factor : 1.00
 Sigma W : 100052.8 W
 THC : 0.95 A
 V THD : 0.58 %
 A THD : 0.66 %
 P THD : 0.00 %

[Maximum]
 Voltage(rms) : 230.54 V
 Current(rms) : 144.53 A
 Frequency : 50.20 Hz
 Power Factor : 1.00
 Sigma W : 100099.2 W
 THC : 0.99 A
 V THD : 0.60 %
 A THD : 0.72 %
 P THD : 0.00 %

Order	Measure[%]	Limit[%]	Margin[%]
2	0.0995	8.0000	98.8
3	0.1107	21.6000	99.5
4	0.0627	4.0000	98.4
5	0.1817	10.7000	98.3
6	0.0574	2.6667	97.9
7	0.2324	7.2000	96.8
8	0.0294	2.0000	98.5
9	0.0562	3.8000	98.5
10	0.0414	1.6000	97.4
11	0.1996	3.1000	93.6
12	0.0359	1.3333	97.3
13	0.1922	2.0000	90.4
TH	0.0000	23.0000	100.0
PWH	0.0000	23.0000	100.0

Order	Measure[%]	Limit[%]	Margin[%]
2	0.1117	12.0000	99.1
3	0.1480	32.4000	99.5
4	0.0834	6.0000	98.6
5	0.1924	16.0500	98.8
6	0.0701	4.0000	98.2
7	0.2484	10.8000	97.7
8	0.0357	3.0000	98.8
9	0.0765	5.7000	98.7
10	0.0570	2.4000	97.6
11	0.2332	4.6500	95.0
12	0.0442	2.0000	97.8
13	0.2046	3.0000	93.2
TH	0.0000	34.5000	100.0
PWH	0.0000	34.5000	100.0

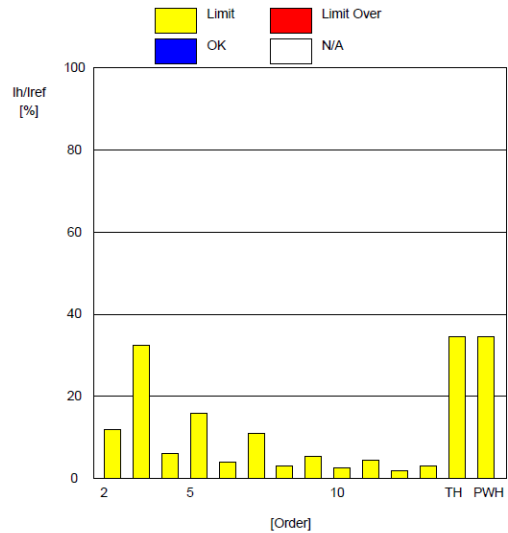
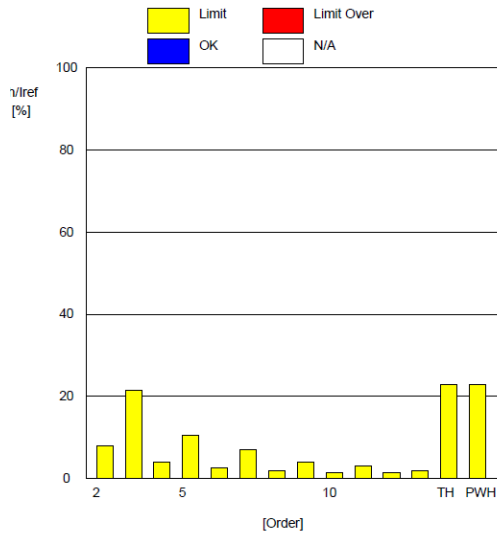

Bureau Veritas Shenzhen Co., Ltd.
Dongguan Branch

No. 96, Guantai Road (Houjie Section), Houjie
Town, Dongguan City, Guangdong Province.
523942. People's Republic of China

Tel: +86 769 8998 2098
Fax: +86 769 8593 1080
Email: customerservice.dg@bureauveritas.com



BUREAU VERITAS

Test Report No.: CE2312WDG0186

Regulation : IEC61000-3-12 Ed2.0
IEC61000-4-7 Ed2.0 A1
MeasureTime : 150sec
Model : YOKOGAWA WT3000
Wiring : 3P4W(3P:three-phase)
Element : 3
Range : 300V/200.0A
Rating Voltage : 400 V
Iequ : 144.4000 A
Z Impedance : 0.0400 ohm
Iref : 144.8746 A
Set Iref :
Power Rsce : 39.832
Max Rsce : 33.000

PASS

Ssc : 3313954.23
Min Rsce : 33.0000
Apply Limit : Table2-Other than balanced 3-phase
Circumstance a : 0.15% (Pass)
Term a(I5) : 0.18% (Pass)
Term a(I7) : 0.27% (Pass)
Term c : 21.67 - 60.28deg (Fail)
Term d(I5) : 0.18% (Pass)
Term d(I7) : 0.27% (Pass)
Term f : 21.67 - 60.28deg (Fail)

[Average]
Voltage(rms) : 230.32 V
Current(rms) : 144.87 A
Frequency : 50.00 Hz
Power Factor : 1.00
Sigma W : 100052.8 W
THC : 0.91 A
V THD : 0.58 %
A THD : 0.63 %
P THD : 0.00 %

[Maximum]
Voltage(rms) : 230.33 V
Current(rms) : 144.95 A
Frequency : 50.20 Hz
Power Factor : 1.00
Sigma W : 100099.2 W
THC : 0.93 A
V THD : 0.60 %
A THD : 0.69 %
P THD : 0.00 %

Table with 4 columns: Order, Measure[%], Limit[%], Margin[%]. Rows 2-13 and TH, PWH.

Table with 4 columns: Order, Measure[%], Limit[%], Margin[%]. Rows 2-13 and TH, PWH.

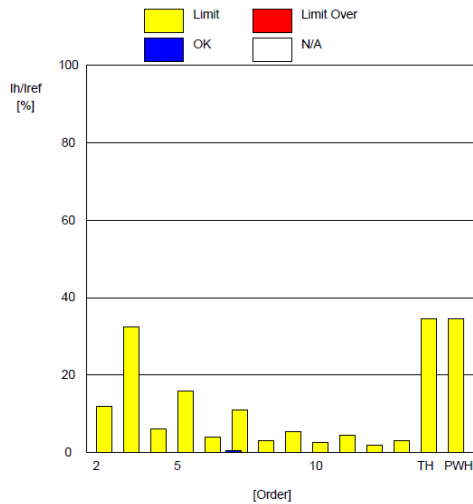
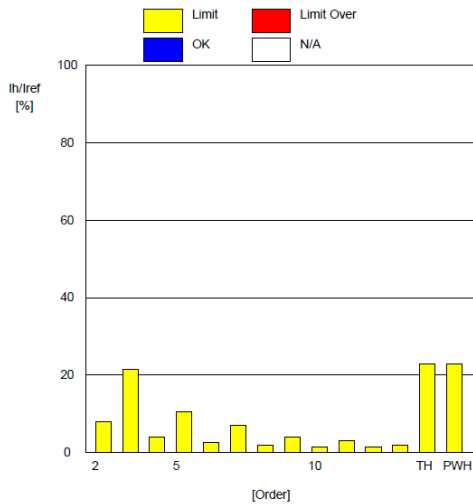

Bureau Veritas Shenzhen Co., Ltd. Dongguan Branch

No. 96, Guantai Road (Houjie Section), Houjie Town, Dongguan City, Guangdong Province. 523942. People's Republic of China

Tel: +86 769 8998 2098
Fax: +86 769 8593 1080
Email: customerservice.dg@bureauveritas.com



BUREAU VERITAS

Test Report No.: CE2312WDG0186

AC 480V 10% Load:

Regulation : IEC61000-3-12 Ed2.0
 IEC61000-4-7 Ed2.0 A1
 MeasureTime : 150sec
 Model : YOKOGAWA WT3000
 Wiring : 3P4W(3P:three-phase)
 Element : 1
 Range : 300V/200.0A
 Rating Voltage : 400 V
 I_{equ} : 120.3000 A
 Z Impedance : 0.0400 ohm
 I_{ref} : 12.1625 A
 Set I_{ref} : -----
 Power Rsce : 472.629
 Max Rsce : 33.000

PASS

Ssc : 279288.96
 Min Rsce : 33.0000
 Apply Limit : Table2-Other than balanced 3-phase
 Circumstance a : 0.78% (Pass)
 Term a(I5) : 0.89% (Pass)
 Term a(I7) : 1.03% (Pass)
 Term c : 4.51 - 359.03deg (Fail)
 Term d(I5) : 0.89% (Pass)
 Term d(I7) : 1.03% (Pass)
 Term f : 4.51 - 359.03deg (Fail)

[Average]
 Voltage(rms) : 277.36 V
 Current(rms) : 12.16 A
 Frequency : 50.00 Hz
 Power Factor : 1.00
 Sigma W : 3361.82 W
 THC : 0.35 A
 V THD : 0.09 %
 A THD : 2.93 %
 P THD : 0.00 %

[Maximum]
 Voltage(rms) : 277.37 V
 Current(rms) : 12.18 A
 Frequency : 50.03 Hz
 Power Factor : 1.00
 Sigma W : 10125.83 W
 THC : 0.50 A
 V THD : 0.14 %
 A THD : 4.97 %
 P THD : 0.00 %

Order	Measure[%]	Limit[%]	Margin[%]
2	0.5885	8.0000	92.6
3	0.5219	21.6000	97.6
4	0.3862	4.0000	90.3
5	0.5777	10.7000	94.6
6	0.3130	2.6667	88.3
7	0.7554	7.2000	89.5
8	0.3126	2.0000	84.4
9	0.3860	3.8000	89.8
10	0.2073	1.6000	87.1
11	1.0200	3.1000	67.1
12	0.1945	1.3333	85.4
13	0.7823	2.0000	60.9
TH	1.0200	23.0000	95.6
PWH	0.0000	23.0000	100.0

Order	Measure[%]	Limit[%]	Margin[%]
2	0.7665	12.0000	93.6
3	0.7832	32.4000	97.6
4	0.4456	6.0000	92.6
5	0.8906	16.0500	94.5
6	0.3673	4.0000	90.8
7	1.0337	10.8000	90.4
8	0.3694	3.0000	87.7
9	0.6321	5.7000	88.9
10	0.2340	2.4000	90.2
11	1.8008	4.6500	61.3
12	0.2301	2.0000	88.5
13	1.2960	3.0000	56.8
TH	3.4539	34.5000	90.0
PWH	14.0775	34.5000	59.2

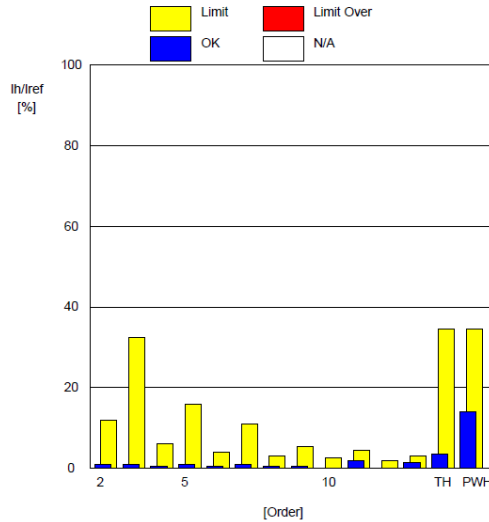
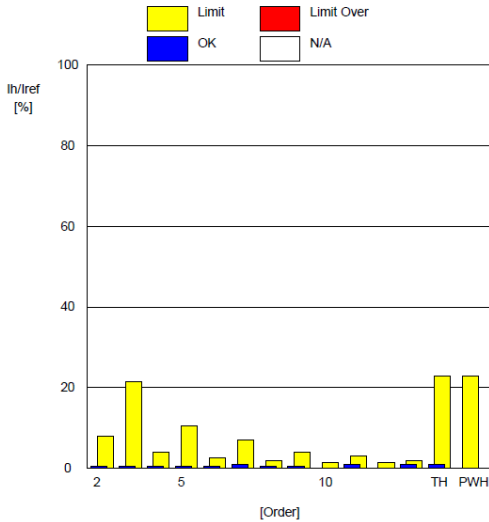

Bureau Veritas Shenzhen Co., Ltd.
Dongguan Branch

No. 96, Guantai Road (Houjie Section), Houjie
Town, Dongguan City, Guangdong Province.
523942, People's Republic of China

Tel: +86 769 8998 2098
Fax: +86 769 8593 1080
Email: customerservice.dg@bureauveritas.com



BUREAU VERITAS

Test Report No.: CE2312WDG0186

Regulation : IEC61000-3-12 Ed2.0
 IEC61000-4-7 Ed2.0 A1
 MeasureTime : 150sec
 Model : YOKOGAWA WT3000
 Wiring : 3P4W(3P:three-phase)
 Element : 2
 Range : 300V/200.0A
 Rating Voltage : 400 V
 I_{equ} : 120.3000 A
 Z Impedance : 0.0400 ohm
 I_{ref} : 12.1281 A
 Set I_{ref} : -----
 Power Rsce : 472.629
 Max Rsce : 33.000

PASS

Ssc : 279288.96
 Min Rsce : 33.0000
 Apply Limit : Table2-Other than balanced 3-phase
 Circumstance a : 0.87% (Pass)
 Term a(I5) : 1.14% (Pass)
 Term a(I7) : 0.92% (Pass)
 Term c : 4.56 - 358.28deg (Fail)
 Term d(I5) : 1.14% (Pass)
 Term d(I7) : 0.92% (Pass)
 Term f : 4.56 - 358.28deg (Fail)

[Average]
 Voltage(rms) : 277.31 V
 Current(rms) : 12.13 A
 Frequency : 50.00 Hz
 Power Factor : 1.00
 Sigma W : 3361.82 W
 THC : 0.32 A
 V THD : 0.09 %
 A THD : 2.70 %
 P THD : 0.00 %

[Maximum]
 Voltage(rms) : 277.33 V
 Current(rms) : 12.15 A
 Frequency : 50.03 Hz
 Power Factor : 1.00
 Sigma W : 10125.83 W
 THC : 0.44 A
 V THD : 0.13 %
 A THD : 4.70 %
 P THD : 0.00 %

Order	Measure[%]	Limit[%]	Margin[%]
2	0.4268	8.0000	94.7
3	0.6025	21.6000	97.2
4	0.4275	4.0000	89.3
5	0.6758	10.7000	93.7
6	0.4400	2.6667	83.5
7	0.7266	7.2000	89.9
8	0.3250	2.0000	83.8
9	0.2816	3.8000	92.6
10	0.2360	1.6000	85.3
11	0.8675	3.1000	72.0
12	0.2000	1.3333	85.0
13	0.7454	2.0000	62.7
TH	0.0000	23.0000	100.0
PWH	0.0000	23.0000	100.0

Order	Measure[%]	Limit[%]	Margin[%]
2	0.5466	12.0000	95.4
3	0.8662	32.4000	97.3
4	0.5350	6.0000	91.1
5	1.1402	16.0500	92.9
6	0.4971	4.0000	87.6
7	0.9249	10.8000	91.4
8	0.3743	3.0000	87.5
9	0.3608	5.7000	93.7
10	0.2779	2.4000	88.4
11	1.5100	4.6500	67.5
12	0.2399	2.0000	88.0
13	1.2618	3.0000	57.9
TH	2.8432	34.5000	91.8
PWH	9.9901	34.5000	71.0

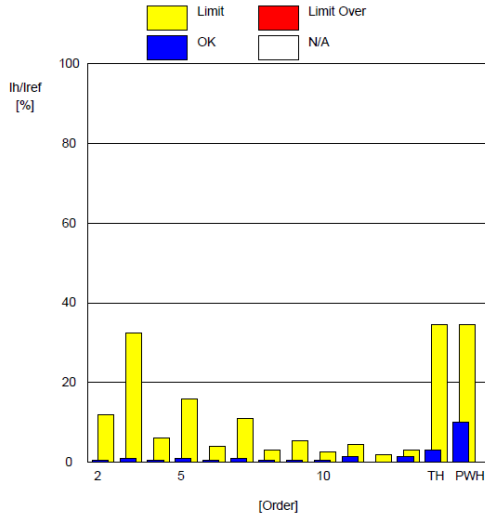
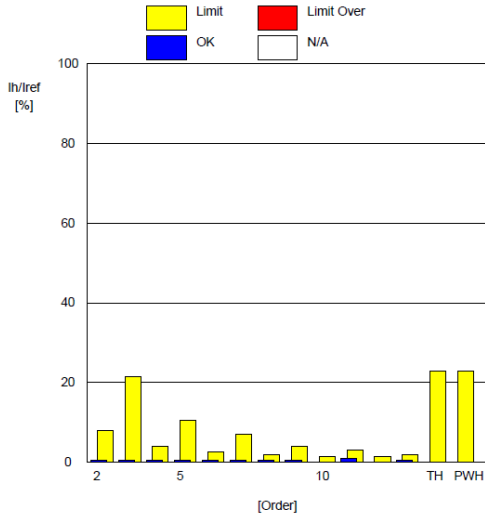

Bureau Veritas Shenzhen Co., Ltd.
Dongguan Branch

No. 96, Guantai Road (Houjie Section), Houjie
Town, Dongguan City, Guangdong Province.
523942, People's Republic of China

Tel: +86 769 8998 2098
Fax: +86 769 8593 1080
Email: customerservice.dg@bureauveritas.com



**BUREAU
VERITAS**

Test Report No.: CE2312WDG0186

Regulation : IEC61000-3-12 Ed2.0
 IEC61000-4-7 Ed2.0 A1
 MeasureTime : 150sec
 Model : YOKOGAWA WT3000
 Wiring : 3P4W(3P:three-phase)
 Element : 3
 Range : 300V/200.0A
 Rating Voltage : 400 V
 I_{equ} : 120.3000 A
 Z Impedance : 0.0400 ohm
 I_{ref} : 12.2005 A
 Set I_{ref} : -----
 Power Rsce : 472.629
 Max Rsce : 33.000

PASS

Ssc : 279288.96
 Min Rsce : 33.0000
 Apply Limit : Table2-Other than balanced 3-phase
 Circumstance a : 1.27% (Pass)
 Term a(I5) : 0.77% (Pass)
 Term a(I7) : 0.97% (Pass)
 Term c : 4.18 - 359.90deg (Fail)
 Term d(I5) : 0.77% (Pass)
 Term d(I7) : 0.97% (Pass)
 Term f : 4.18 - 359.90deg (Fail)

[Average]
 Voltage(rms) : 277.08 V
 Current(rms) : 12.20 A
 Frequency : 50.00 Hz
 Power Factor : 1.00
 Sigma W : 3361.82 W
 THC : 0.33 A
 V THD : 0.08 %
 A THD : 2.77 %
 P THD : 0.00 %

[Maximum]
 Voltage(rms) : 277.09 V
 Current(rms) : 12.22 A
 Frequency : 50.03 Hz
 Power Factor : 1.00
 Sigma W : 10125.83 W
 THC : 0.46 A
 V THD : 0.11 %
 A THD : 4.50 %
 P THD : 0.00 %

Order	Measure[%]	Limit[%]	Margin[%]
2	0.3592	8.0000	95.5
3	0.9531	21.6000	95.6
4	0.2815	4.0000	93.0
5	0.5040	10.7000	95.3
6	0.3997	2.6667	85.0
7	0.6963	7.2000	90.3
8	0.3514	2.0000	82.4
9	0.2932	3.8000	92.3
10	0.2191	1.6000	86.3
11	0.8417	3.1000	72.9
12	0.2035	1.3333	84.7
13	0.7306	2.0000	63.5
TH	0.0000	23.0000	100.0
PWH	0.0000	23.0000	100.0

Order	Measure[%]	Limit[%]	Margin[%]
2	0.4864	12.0000	95.9
3	1.2731	32.4000	96.1
4	0.3538	6.0000	94.1
5	0.7684	16.0500	95.2
6	0.4657	4.0000	88.4
7	0.9705	10.8000	91.0
8	0.4181	3.0000	86.1
9	0.3732	5.7000	93.5
10	0.2474	2.4000	89.7
11	1.4898	4.6500	68.0
12	0.2384	2.0000	88.1
13	1.2545	3.0000	58.2
TH	3.1121	34.5000	91.0
PWH	12.0852	34.5000	65.0

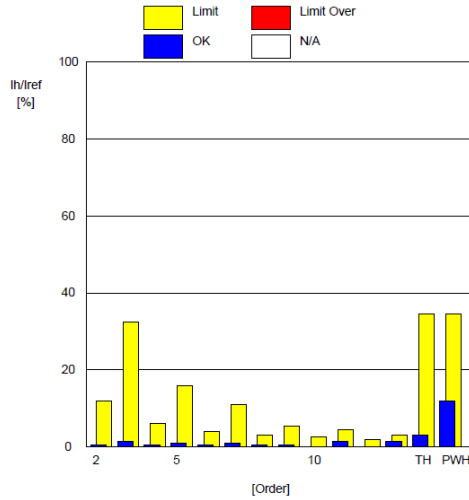
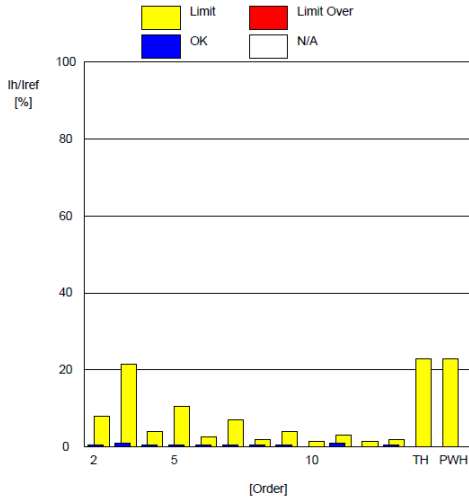

**Bureau Veritas Shenzhen Co., Ltd.
Dongguan Branch**

No. 96, Guantai Road (Houjie Section), Houjie
Town, Dongguan City, Guangdong Province.
523942. People's Republic of China

Tel: +86 769 8998 2098
Fax: +86 769 8593 1080
Email: customerservice.dg@bureauveritas.com



**BUREAU
VERITAS**

Test Report No.: CE2312WDG0186

AC 480V 50% Load

Regulation : IEC61000-3-12 Ed2.0
 IEC61000-4-7 Ed2.0 A1
 MeasureTime : 150sec
 Model : YOKOGAWA WT3000
 Wiring : 3P4W(3P.three-phase)
 Element : 1
 Range : 300V/200.0A
 Rating Voltage : 400 V
 Ieq : 120.3000 A
 Z Impedance : 0.0400 ohm
 Iref : 60.7164 A
 Set Iref : -----
 Power Rsce : 95.039
 Max Rsce : 33.000

PASS

Ssc : 1388905.81
 Min Rsce : 33.0000
 Apply Limit : Table2-Other than balanced 3-phase
 Circumstance a : 0.15% (Pass)
 Term a(I5) : 0.26% (Pass)
 Term a(I7) : 0.24% (Pass)
 Term c : 19.92 - 153.72deg (Fail)
 Term d(I5) : 0.26% (Pass)
 Term d(I7) : 0.24% (Pass)
 Term f : 19.92 - 153.72deg (Fail)

[Average]
 Voltage(rms) : 277.45 V
 Current(rms) : 60.72 A
 Frequency : 50.00 Hz
 Power Factor : 1.00
 Sigma W : 50449.82 W
 THC : 0.51 A
 V THD : 0.43 %
 A THD : 0.85 %
 P THD : 0.00 %

[Maximum]
 Voltage(rms) : 277.47 V
 Current(rms) : 60.75 A
 Frequency : 50.04 Hz
 Power Factor : 1.00
 Sigma W : 50476.36 W
 THC : 0.55 A
 V THD : 0.45 %
 A THD : 1.04 %
 P THD : 0.00 %

Order	Measure[%]	Limit[%]	Margin[%]
2	0.2526	8.0000	96.8
3	0.1159	21.6000	99.5
4	0.0995	4.0000	97.5
5	0.1952	10.7000	98.2
6	0.0660	2.6667	97.5
7	0.2063	7.2000	97.1
8	0.0478	2.0000	97.6
9	0.1244	3.8000	96.7
10	0.0500	1.6000	96.9
11	0.2757	3.1000	91.1
12	0.0446	1.3333	96.7
13	0.2416	2.0000	87.9
TH	0.0000	23.0000	100.0
PWH	0.0000	23.0000	100.0

Order	Measure[%]	Limit[%]	Margin[%]
2	0.2768	12.0000	97.7
3	0.1462	32.4000	99.5
4	0.1291	6.0000	97.8
5	0.2561	16.0500	98.4
6	0.0790	4.0000	98.0
7	0.2447	10.8000	97.7
8	0.0600	3.0000	98.0
9	0.1421	5.7000	97.5
10	0.0565	2.4000	97.6
11	0.3477	4.6500	92.5
12	0.0504	2.0000	97.5
13	0.2846	3.0000	90.5
TH	0.0000	34.5000	100.0
PWH	0.0000	34.5000	100.0

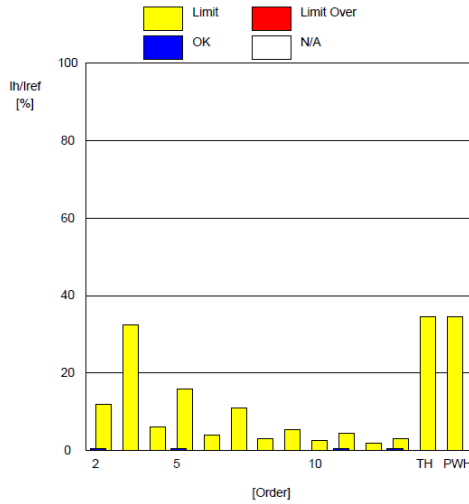
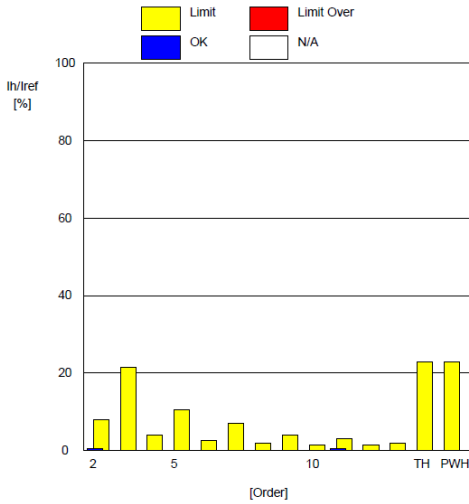

**Bureau Veritas Shenzhen Co., Ltd.
Dongguan Branch**

No. 96, Guantai Road (Houjie Section), Houjie
Town, Dongguan City, Guangdong Province.
523942. People's Republic of China

Tel: +86 769 8998 2098
Fax: +86 769 8593 1080
Email: customerservice.dg@bureauveritas.com



Regulation : IEC61000-3-12 Ed2.0
 IEC61000-4-7 Ed2.0 A1
 MeasureTime : 150sec
 Model : YOKOGAWA WT3000
 Wiring : 3P4W(3P:three-phase)
 Element : 2
 Range : 300V/200.0A
 Rating Voltage : 400 V
 I_{equ} : 120.3000 A
 Z Impedance : 0.0400 ohm
 I_{ref} : 60.4795 A
 Set I_{ref} : -----
 Power Rsce : 95.039
 Max Rsce : 33.000

PASS

Ssc : 1388905.81
 Min Rsce : 33.0000
 Apply Limit : Table2-Other than balanced 3-phase
 Circumstance a : 0.37% (Pass)
 Term a(I5) : 0.32% (Pass)
 Term a(I7) : 0.22% (Pass)
 Term c : 47.98 - 137.09deg (Fail)
 Term d(I5) : 0.32% (Pass)
 Term d(I7) : 0.22% (Pass)
 Term f : 47.98 - 137.09deg (Fail)

[Average]
 Voltage(rms) : 277.41 V
 Current(rms) : 60.48 A
 Frequency : 50.00 Hz
 Power Factor : 1.00
 Sigma W : 50449.82 W
 THC : 0.57 A
 V THD : 0.44 %
 A THD : 0.95 %
 P THD : 0.00 %

[Maximum]
 Voltage(rms) : 277.43 V
 Current(rms) : 60.51 A
 Frequency : 50.04 Hz
 Power Factor : 1.00
 Sigma W : 50476.36 W
 THC : 0.62 A
 V THD : 0.45 %
 A THD : 1.14 %
 P THD : 0.00 %

Order	Measure[%]	Limit[%]	Margin[%]
2	0.1925	8.0000	97.6
3	0.3143	21.6000	98.5
4	0.1117	4.0000	97.2
5	0.2823	10.7000	97.4
6	0.0977	2.6667	96.3
7	0.1725	7.2000	97.6
8	0.0529	2.0000	97.4
9	0.0839	3.8000	97.8
10	0.0615	1.6000	96.2
11	0.3315	3.1000	89.3
12	0.0538	1.3333	96.0
13	0.2210	2.0000	89.0
TH	0.0000	23.0000	100.0
PWH	0.0000	23.0000	100.0

Order	Measure[%]	Limit[%]	Margin[%]
2	0.2251	12.0000	98.1
3	0.3653	32.4000	98.9
4	0.1454	6.0000	97.6
5	0.3247	16.0500	98.0
6	0.1097	4.0000	97.3
7	0.2173	10.8000	98.0
8	0.0614	3.0000	98.0
9	0.1025	5.7000	98.2
10	0.0743	2.4000	96.9
11	0.4048	4.6500	91.3
12	0.0614	2.0000	96.9
13	0.2657	3.0000	91.1
TH	0.0000	34.5000	100.0
PWH	0.0000	34.5000	100.0

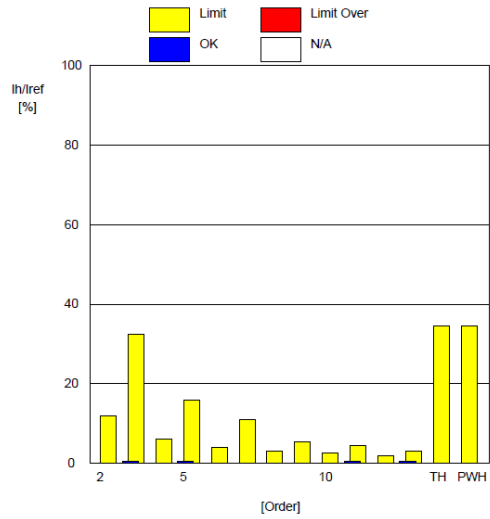
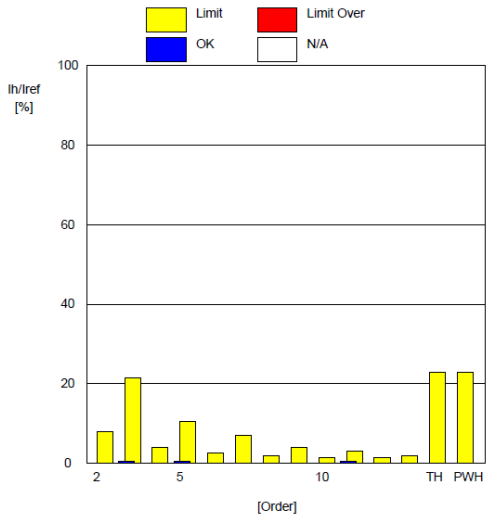



BUREAU VERITAS

Test Report No.: CE2312WDG0186

Regulation : IEC61000-3-12 Ed.2
 IEC61000-4-7 Ed.2.0 A1
 MeasureTime : 150sec
 Model : YOKOGAWA WT3000
 Wiring : 3P4W(3P:three-phase)
 Element : 3
 Range : 300V/200.0A
 Rating Voltage : 400 V
 I_{eq} : 120.3000 A
 Z Impedance : 0.0400 ohm
 I_{ref} : 60.7173 A
 Set I_{ref} : -----
 Power R_{sce} : 95.039
 Max R_{sce} : 33.000

PASS

Ssc : 1388905.81
 Min R_{sce} : 33.0000
 Apply Limit : Table2-Other than balanced 3-phase
 Circumstance a : 0.38% (Pass)
 Term a(I5) : 0.32% (Pass)
 Term a(I7) : 0.30% (Pass)
 Term c : 29.94 - 107.43deg (Fail)
 Term d(I5) : 0.32% (Pass)
 Term d(I7) : 0.30% (Pass)
 Term f : 29.94 - 107.43deg (Fail)

[Average]
 Voltage(rms) : 277.17 V
 Current(rms) : 60.72 A
 Frequency : 50.00 Hz
 Power Factor : 1.00
 Sigma W : 50449.82 W
 THC : 0.54 A
 V THD : 0.43 %
 A THD : 0.89 %
 P THD : 0.00 %

[Maximum]
 Voltage(rms) : 277.19 V
 Current(rms) : 60.75 A
 Frequency : 50.04 Hz
 Power Factor : 1.00
 Sigma W : 50476.36 W
 THC : 0.60 A
 V THD : 0.44 %
 A THD : 1.09 %
 P THD : 0.00 %

Order	Measure[%]	Limit[%]	Margin[%]
2	0.1877	8.0000	97.7
3	0.3064	21.6000	98.6
4	0.0854	4.0000	97.9
5	0.2809	10.7000	97.4
6	0.0957	2.6667	96.4
7	0.2390	7.2000	96.7
8	0.0516	2.0000	97.4
9	0.1023	3.8000	97.3
10	0.0540	1.6000	96.6
11	0.2859	3.1000	90.8
12	0.0546	1.3333	95.9
13	0.1800	2.0000	91.0
TH	0.0000	23.0000	100.0
PWH	0.0000	23.0000	100.0

Order	Measure[%]	Limit[%]	Margin[%]
2	0.2083	12.0000	98.3
3	0.3782	32.4000	98.8
4	0.1107	6.0000	98.2
5	0.3160	16.0500	98.0
6	0.1079	4.0000	97.3
7	0.3006	10.8000	97.2
8	0.0702	3.0000	97.7
9	0.1141	5.7000	98.0
10	0.0745	2.4000	96.9
11	0.3616	4.6500	92.2
12	0.0654	2.0000	96.7
13	0.2202	3.0000	92.7
TH	0.0000	34.5000	100.0
PWH	0.0000	34.5000	100.0

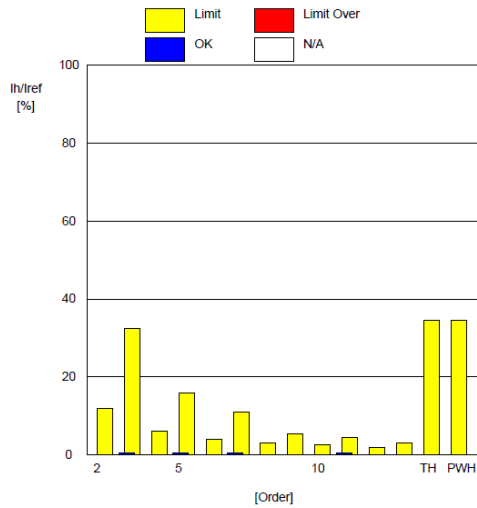
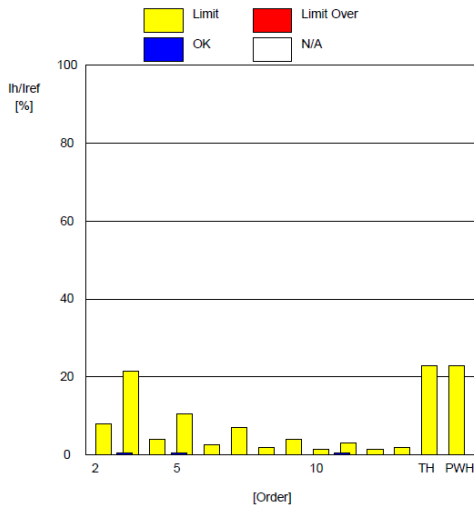

Bureau Veritas Shenzhen Co., Ltd.
 Dongguan Branch

No. 96, Guantai Road (Houjie Section), Houjie
 Town, Dongguan City, Guangdong Province.
 523942. People's Republic of China

Tel: +86 769 8998 2098
 Fax: +86 769 8593 1080
 Email: customerservice.dg@bureauveritas.com



AC 480V Full Load:

Regulation	:	IEC61000-3-12 Ed2.0
	:	IEC61000-4-7 Ed2.0 A1
MeasureTime	:	150sec
Model	:	YOKOGAWA WT3000
Wiring	:	3P4W(3P.three-phase)
Element	:	1
Range	:	300V/200.0A
Rating Voltage	:	400 V
I _{equ}	:	120.3000 A
Z Impedance	:	0.0400 ohm
I _{ref}	:	121.0161 A
Set I _{ref}	:	-----
Power R _{sce}	:	47.690
Max R _{sce}	:	33.000

PASS

Ssc	:	2767892.58
Min R _{sce}	:	33.0000
Apply Limit	:	Table2-Other than balanced 3-phase
Circumstance a	:	0.16% (Pass)
Term a(I5)	:	0.48% (Pass)
Term a(I7)	:	0.25% (Pass)
Term c	:	4.03 - 37.20deg (Fail)
Term d(I5)	:	0.48% (Pass)
Term d(I7)	:	0.25% (Pass)
Term f	:	4.03 - 37.20deg (Fail)

[Average]			
Voltage(rms)	:	277.57 V	
Current(rms)	:	121.02 A	
Frequency	:	50.00 Hz	
Power Factor	:	1.00	
Sigma W	:	100604.2 W	
THC	:	1.00 A	
V THD	:	0.47 %	
A THD	:	0.83 %	
P THD	:	0.00 %	

[Maximum]			
Voltage(rms)	:	277.58 V	
Current(rms)	:	121.06 A	
Frequency	:	50.11 Hz	
Power Factor	:	1.00	
Sigma W	:	100641.3 W	
THC	:	1.04 A	
V THD	:	0.48 %	
A THD	:	0.93 %	
P THD	:	0.00 %	

Order	Measure[%]	Limit[%]	Margin[%]
2	0.1924	8.0000	97.6
3	0.1204	21.6000	99.4
4	0.0429	4.0000	98.9
5	0.3865	10.7000	96.4
6	0.0395	2.6667	98.5
7	0.2074	7.2000	97.1
8	0.0269	2.0000	98.7
9	0.0563	3.8000	98.5
10	0.0256	1.6000	98.4
11	0.2843	3.1000	90.8
12	0.0245	1.3333	98.2
13	0.2039	2.0000	89.8
TH	0.0000	23.0000	100.0
PWH	0.0000	23.0000	100.0

Order	Measure[%]	Limit[%]	Margin[%]
2	0.2046	12.0000	98.3
3	0.1630	32.4000	99.5
4	0.0520	6.0000	99.1
5	0.4822	16.0500	97.0
6	0.0467	4.0000	98.8
7	0.2492	10.8000	97.7
8	0.0320	3.0000	98.9
9	0.0695	5.7000	98.8
10	0.0303	2.4000	98.7
11	0.3215	4.6500	93.1
12	0.0274	2.0000	98.6
13	0.2443	3.0000	91.9
TH	0.0000	34.5000	100.0
PWH	0.0000	34.5000	100.0

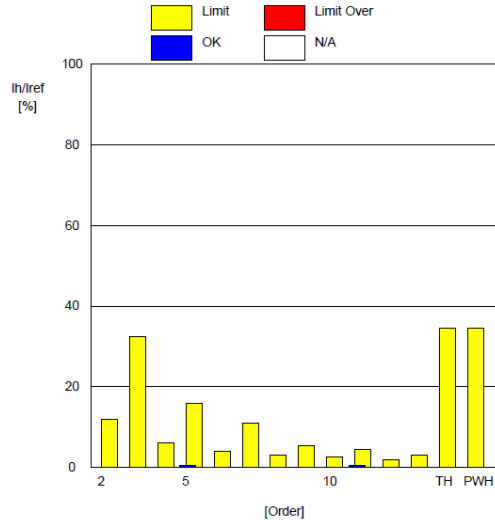
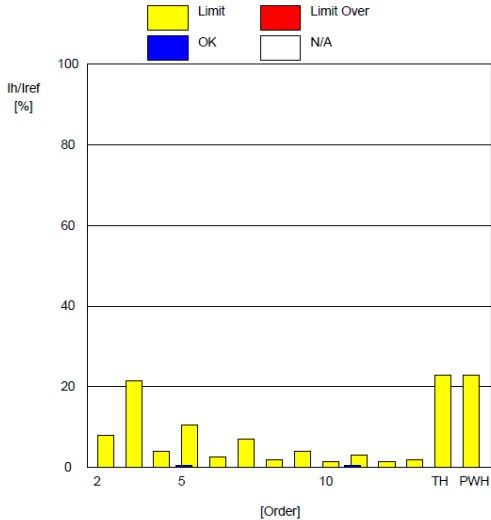



BUREAU VERITAS

Test Report No.: CE2312WDG0186

Regulation : IEC61000-3-12 Ed2.0
 IEC61000-4-7 Ed2.0 A1
 MeasureTime : 150sec
 Model : YOKOGAWA WT3000
 Wiring : 3P4W(3P-three-phase)
 Element : 2
 Range : 300V/200.0A
 Rating Voltage : 400 V
 I_{eq} : 120.3000 A
 Z Impedance : 0.0400 ohm
 I_{ref} : 120.6017 A
 Set I_{ref} : -----
 Power Rsce : 47.690
 Max Rsce : 33.000

PASS

Ssc : 2767892.58
 Min Rsce : 33.0000
 Apply Limit : Table2-Other than balanced 3-phase
 Circumstance a : 0.21% (Pass)
 Term a(I5) : 0.29% (Pass)
 Term a(I7) : 0.30% (Pass)
 Term c : 0.26 - 359.81deg (Fail)
 Term d(I5) : 0.29% (Pass)
 Term d(I7) : 0.30% (Pass)
 Term f : 0.26 - 359.81deg (Fail)

[Average]
 Voltage(rms) : 277.53 V
 Current(rms) : 120.60 A
 Frequency : 50.00 Hz
 Power Factor : 1.00
 Sigma W : 100604.2 W
 THC : 0.97 A
 V THD : 0.48 %
 A THD : 0.81 %
 P THD : 0.00 %

[Maximum]
 Voltage(rms) : 277.55 V
 Current(rms) : 120.65 A
 Frequency : 50.11 Hz
 Power Factor : 1.00
 Sigma W : 100641.3 W
 THC : 1.03 A
 V THD : 0.50 %
 A THD : 0.91 %
 P THD : 0.00 %

Order	Measure[%]	Limit[%]	Margin[%]
2	0.1809	8.0000	97.7
3	0.1741	21.6000	99.2
4	0.0565	4.0000	98.6
5	0.2113	10.7000	98.0
6	0.0625	2.6667	97.7
7	0.2555	7.2000	96.5
8	0.0280	2.0000	98.6
9	0.0848	3.8000	97.8
10	0.0266	1.6000	98.3
11	0.2591	3.1000	91.6
12	0.0305	1.3333	97.7
13	0.2079	2.0000	89.6
TH	0.0000	23.0000	100.0
PWH	0.0000	23.0000	100.0

Order	Measure[%]	Limit[%]	Margin[%]
2	0.1957	12.0000	98.4
3	0.2128	32.4000	99.3
4	0.0714	6.0000	98.8
5	0.2922	16.0500	98.2
6	0.0689	4.0000	98.3
7	0.2976	10.8000	97.2
8	0.0344	3.0000	98.9
9	0.1092	5.7000	98.1
10	0.0317	2.4000	98.7
11	0.3064	4.6500	93.4
12	0.0349	2.0000	98.3
13	0.2563	3.0000	91.5
TH	0.0000	34.5000	100.0
PWH	0.0000	34.5000	100.0

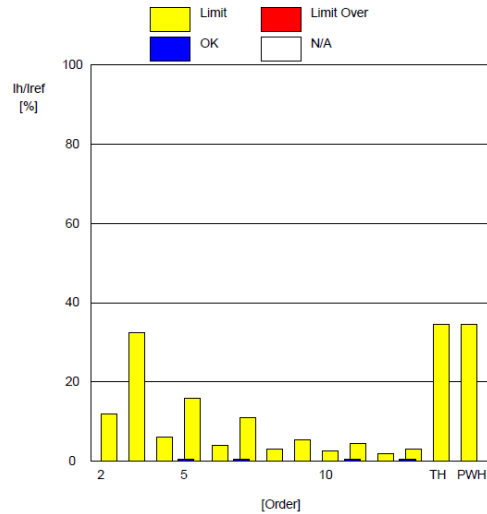
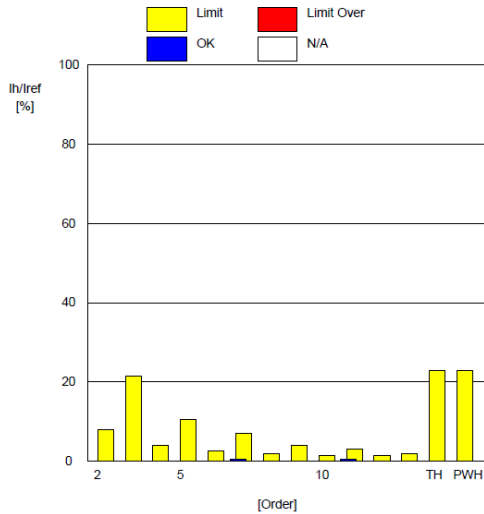

Bureau Veritas Shenzhen Co., Ltd.
Dongguan Branch

No. 96, Guantai Road (Houjie Section), Houjie
Town, Dongguan City, Guangdong Province.
523942. People's Republic of China

Tel: +86 769 8998 2098
Fax: +86 769 8593 1080
Email: customerservice.dg@bureauveritas.com



BUREAU VERITAS

Test Report No.: CE2312WDG0186

Regulation : IEC61000-3-12 Ed2.0
 IEC61000-4-7 Ed2.0 A1
 MeasureTime : 150sec
 Model : YOKOGAWA WT3000
 Wiring : 3P4W(3P:three-phase)
 Element : 3
 Range : 300V/200.0A
 Rating Voltage : 400 V
 I_{eq} : 120.3000 A
 Z Impedance : 0.0400 ohm
 I_{ref} : 120.9845 A
 Set I_{ref} : -----
 Power Rsce : 47.690
 Max Rsce : 33.000

PASS

Ssc : 2767892.58
 Min Rsce : 33.0000

Apply Limit : Table2-Other than balanced 3-phase
 Circumstance a : 0.30% (Pass)
 Term a(I5) : 0.41% (Pass)
 Term a(I7) : 0.37% (Pass)
 Term c : 24.59 - 77.55deg (Fail)
 Term d(I5) : 0.41% (Pass)
 Term d(I7) : 0.37% (Pass)
 Term f : 24.59 - 77.55deg (Fail)

[Average]
 Voltage(rms) : 277.29 V
 Current(rms) : 120.98 A
 Frequency : 50.00 Hz
 Power Factor : 1.00
 Sigma W : 100604.2 W
 THC : 1.01 A
 V THD : 0.47 %
 A THD : 0.84 %
 P THD : 0.00 %

[Maximum]
 Voltage(rms) : 277.30 V
 Current(rms) : 121.03 A
 Frequency : 50.11 Hz
 Power Factor : 1.00
 Sigma W : 100641.3 W
 THC : 1.04 A
 V THD : 0.48 %
 A THD : 0.93 %
 P THD : 0.00 %

Order	Measure[%]	Limit[%]	Margin[%]
2	0.1979	8.0000	97.5
3	0.2516	21.6000	98.8
4	0.0424	4.0000	98.9
5	0.3124	10.7000	97.1
6	0.0519	2.6667	98.1
7	0.3071	7.2000	95.7
8	0.0277	2.0000	98.6
9	0.0594	3.8000	98.4
10	0.0268	1.6000	98.3
11	0.2266	3.1000	92.7
12	0.0330	1.3333	97.5
13	0.1981	2.0000	90.1
TH	0.0000	23.0000	100.0
PWH	0.0000	23.0000	100.0

Order	Measure[%]	Limit[%]	Margin[%]
2	0.2079	12.0000	98.3
3	0.2952	32.4000	99.1
4	0.0545	6.0000	99.1
5	0.4085	16.0500	97.5
6	0.0598	4.0000	98.5
7	0.3679	10.8000	96.6
8	0.0325	3.0000	98.9
9	0.0805	5.7000	98.6
10	0.0313	2.4000	98.7
11	0.2683	4.6500	94.2
12	0.0387	2.0000	98.1
13	0.2571	3.0000	91.4
TH	0.0000	34.5000	100.0
PWH	0.0000	34.5000	100.0

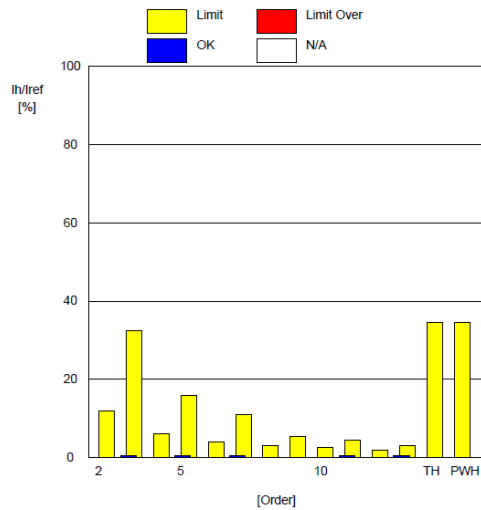
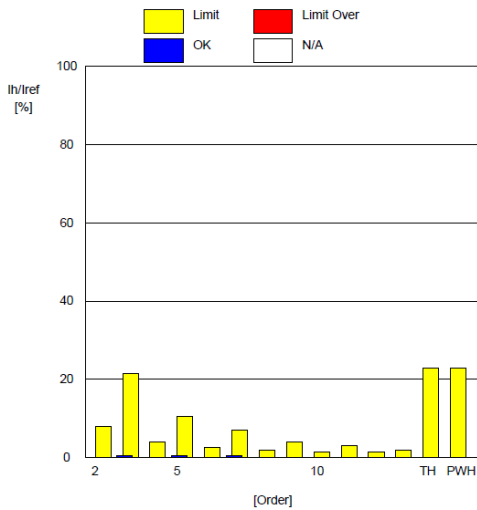

**Bureau Veritas Shenzhen Co., Ltd.
 Dongguan Branch**

No. 96, Guantai Road (Houjie Section), Houjie
 Town, Dongguan City, Guangdong Province.
 523942. People's Republic of China

Tel: +86 769 8998 2098
 Fax: +86 769 8593 1080
 Email: customerservice.dg@bureauveritas.com



BUREAU VERITAS

Test Report No.: CE2312WDG0186

SUN2000-115KTL-M2 AC 400V 25% Load:

Regulation : IEC61000-3-12 Ed2.0
 IEC61000-4-7 Ed2.0 A1
 MeasureTime : 150sec
 Model : YOKOGAWA WT3000
 Wiring : 3P4W(3P:three-phase)
 Element : 1
 Range : 300V/200.0A
 Rating Voltage : 400 V
 I_{equ} : 15.0000 A
 Z Impedance : 0.2400 ohm
 I_{ref} : 40.9824 A
 Set I_{ref} : -----
 Power Rsce : 64.150
 Max Rsce : 33.000

PASS

Ssc : 342946.06
 Min Rsce : 33.0000
 Apply Limit : Table3-Balanced 3-phase
 Circumstance a : 0.17% (Pass)
 Term a(15) : 0.35% (Pass)
 Term a(17) : 0.51% (Pass)
 Term c : 0.45 - 351.91deg (Fail)
 Term d(15) : 0.35% (Pass)
 Term d(17) : 0.51% (Pass)
 Term f : 0.45 - 351.91deg (Fail)

[Average]
 Voltage(rms) : 231.33 V
 Current(rms) : 40.98 A
 Frequency : 50.00 Hz
 Power Factor : 1.00
 Sigma W : 28253.90 W
 THC : 0.40 A
 V THD : 1.65 %
 A THD : 1.00 %
 P THD : 0.00 %

[Maximum]
 Voltage(rms) : 233.18 V
 Current(rms) : 41.01 A
 Frequency : 50.37 Hz
 Power Factor : 1.00
 Sigma W : 28590.80 W
 THC : 0.43 A
 V THD : 1.92 %
 A THD : 1.20 %
 P THD : 0.00 %

Order	Measure[%]	Limit[%]	Margin[%]
2	0.1672	8.0000	97.9
3	0.1471	-----	-----
4	0.1134	4.0000	97.2
5	0.2883	10.7000	97.3
6	0.1259	2.6667	95.3
7	0.3977	7.2000	94.5
8	0.2031	2.0000	89.8
9	0.1516	-----	-----
10	0.2087	1.6000	87.0
11	0.1899	3.1000	93.9
12	0.0902	1.3333	93.2
13	0.1421	2.0000	92.9
TH	0.0000	13.0000	100.0
PWH	0.0000	22.0000	100.0

Order	Measure[%]	Limit[%]	Margin[%]
2	0.1990	12.0000	98.3
3	0.1726	-----	-----
4	0.1391	6.0000	97.7
5	0.3472	16.0500	97.8
6	0.1448	4.0000	96.4
7	0.5148	10.8000	95.2
8	0.2366	3.0000	92.1
9	0.2182	-----	-----
10	0.2504	2.4000	89.6
11	0.2926	4.6500	93.7
12	0.1031	2.0000	94.8
13	0.1935	3.0000	93.6
TH	0.0000	19.5000	100.0
PWH	0.0000	33.0000	100.0

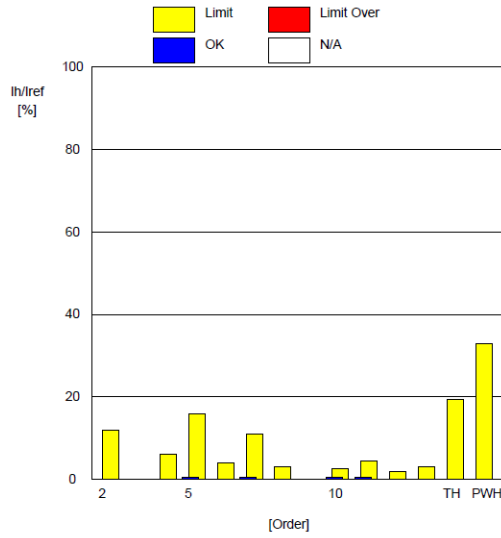
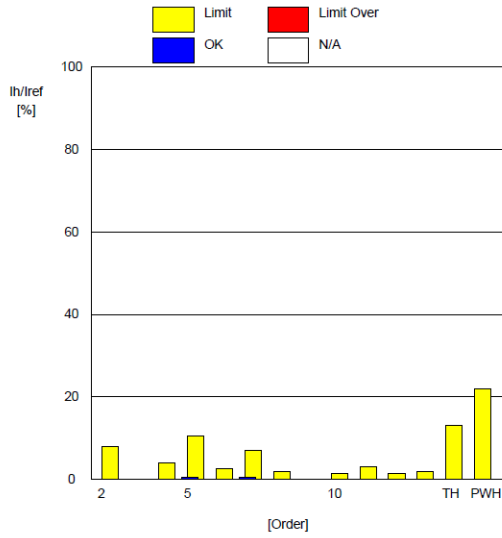

Bureau Veritas Shenzhen Co., Ltd.
Dongguan Branch

No. 96, Guantai Road (Houjie Section), Houjie
Town, Dongguan City, Guangdong Province.
523942. People's Republic of China

Tel: +86 769 8998 2098
Fax: +86 769 8593 1080
Email: customerservice.dg@bureauveritas.com



Regulation : IEC61000-3-12 Ed2.0
 IEC61000-4-7 Ed2.0 A1
 MeasureTime : 150sec
 Model : YOKOGAWA WT3000
 Wiring : 3P4W(3P:three-phase)
 Element : 2
 Range : 300V/200.0A
 Rating Voltage : 400 V
 I_{eq} : 15.0000 A
 Z Impedance : 0.2400 ohm
 I_{ref} : 40.6858 A
 Set I_{ref} : -----
 Power R_{sce} : 64.150
 Max R_{sce} : 33.000

PASS

Ssc : 342946.06
 Min R_{sce} : 33.0000
 Apply Limit : Table3-Balanced 3-phase
 Circumstance a : 0.20% (Pass)
 Term a(I5) : 0.39% (Pass)
 Term a(I7) : 0.47% (Pass)
 Term c : 3.05 - 357.38deg (Fail)
 Term d(I5) : 0.39% (Pass)
 Term d(I7) : 0.47% (Pass)
 Term f : 3.05 - 357.38deg (Fail)

[Average]

Voltage(rms) : 229.16 V
 Current(rms) : 40.69 A
 Frequency : 50.00 Hz
 Power Factor : 1.00
 Sigma W : 28253.90 W
 THC : 0.41 A
 V THD : 1.67 %
 A THD : 1.02 %
 P THD : 0.00 %

[Maximum]

Voltage(rms) : 232.43 V
 Current(rms) : 40.71 A
 Frequency : 50.37 Hz
 Power Factor : 1.00
 Sigma W : 28590.80 W
 THC : 0.43 A
 V THD : 1.93 %
 A THD : 1.20 %
 P THD : 0.00 %

Order	Measure[%]	Limit[%]	Margin[%]
2	0.1864	8.0000	97.7
3	0.1624	-----	-----
4	0.1186	4.0000	97.0
5	0.3000	10.7000	97.2
6	0.1260	2.6667	95.3
7	0.3733	7.2000	94.8
8	0.2139	2.0000	89.3
9	0.1466	-----	-----
10	0.1962	1.6000	87.7
11	0.2105	3.1000	93.2
12	0.0896	1.3333	93.3
13	0.1432	2.0000	92.8
TH	0.0000	13.0000	100.0
PWH	0.0000	22.0000	100.0

Order	Measure[%]	Limit[%]	Margin[%]
2	0.2171	12.0000	98.2
3	0.2044	-----	-----
4	0.1352	6.0000	97.7
5	0.3904	16.0500	97.6
6	0.1414	4.0000	96.5
7	0.4657	10.8000	95.7
8	0.2528	3.0000	91.6
9	0.2180	-----	-----
10	0.2300	2.4000	90.4
11	0.3190	4.6500	93.1
12	0.1042	2.0000	94.8
13	0.1989	3.0000	93.4
TH	0.0000	19.5000	100.0
PWH	0.0000	33.0000	100.0

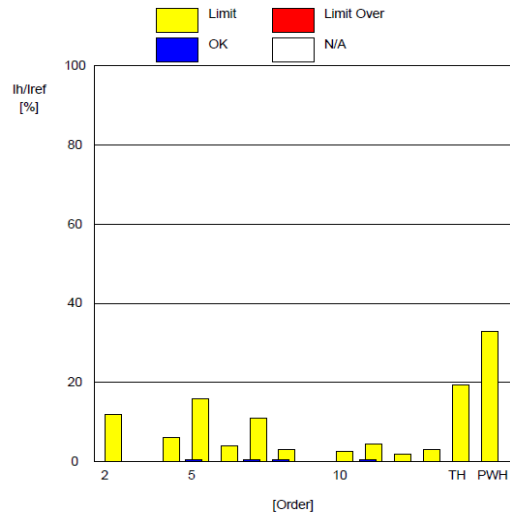
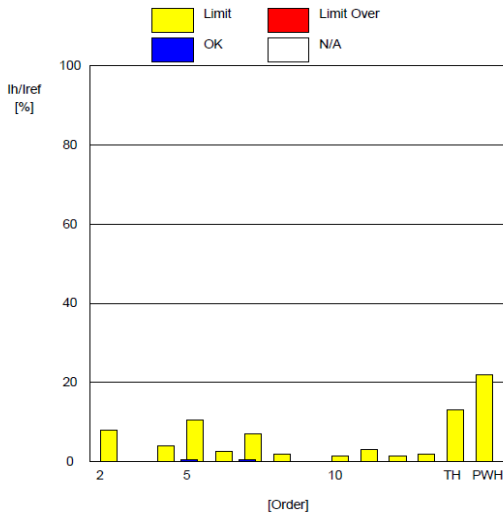

Bureau Veritas Shenzhen Co., Ltd.
 Dongguan Branch

No. 96, Guantai Road (Houjie Section), Houjie
 Town, Dongguan City, Guangdong Province.
 523942. People's Republic of China

Tel: +86 769 8998 2098
 Fax: +86 769 8593 1080
 Email: customerservice.dg@bureauveritas.com



Regulation : IEC61000-3-12 Ed2.0
 IEC61000-4-7 Ed2.0 A1
 MeasureTime : 150sec
 Model : YOKOGAWA WT3000
 Wiring : 3P4W(3P:three-phase)
 Element : 3
 Range : 300V/200.0A
 Rating Voltage : 400 V
 I_{equ} : 15.0000 A
 Z Impedance : 0.2400 ohm
 I_{ref} : 40.9514 A
 Set I_{ref} : -----
 Power R_{sce} : 64.150
 Max R_{sce} : 33.000

PASS

Ssc : 342946.06
 Min R_{sce} : 33.0000
 Apply Limit : Table3-Balanced 3-phase
 Circumstance a : 0.15% (Pass)
 Term a(I5) : 0.39% (Pass)
 Term a(I7) : 0.48% (Pass)
 Term c : 24.44 - 347.28deg (Fail)
 Term d(I5) : 0.39% (Pass)
 Term d(I7) : 0.48% (Pass)
 Term f : 24.44 - 347.28deg (Fail)

[Average]
 Voltage(rms) : 230.94 V
 Current(rms) : 40.95 A
 Frequency : 50.00 Hz
 Power Factor : 1.00
 Sigma W : 28253.90 W
 THC : 0.40 A
 V THD : 1.64 %
 A THD : 0.98 %
 P THD : 0.00 %

[Maximum]
 Voltage(rms) : 233.72 V
 Current(rms) : 40.98 A
 Frequency : 50.37 Hz
 Power Factor : 1.00
 Sigma W : 28590.80 W
 THC : 0.43 A
 V THD : 1.93 %
 A THD : 1.20 %
 P THD : 0.00 %

Order	Measure[%]	Limit[%]	Margin[%]
2	0.2034	8.0000	97.5
3	0.1247	-----	-----
4	0.1207	4.0000	97.0
5	0.3173	10.7000	97.0
6	0.1309	2.6667	95.1
7	0.3870	7.2000	94.6
8	0.2018	2.0000	89.9
9	0.1418	-----	-----
10	0.2089	1.6000	86.9
11	0.1900	3.1000	93.9
12	0.0902	1.3333	93.2
13	0.1375	2.0000	93.1
TH	0.0000	13.0000	100.0
PWH	0.0000	22.0000	100.0

Order	Measure[%]	Limit[%]	Margin[%]
2	0.2435	12.0000	98.0
3	0.1517	-----	-----
4	0.1422	6.0000	97.6
5	0.3919	16.0500	97.6
6	0.1464	4.0000	96.3
7	0.4807	10.8000	95.5
8	0.2412	3.0000	92.0
9	0.2088	-----	-----
10	0.2478	2.4000	89.7
11	0.2743	4.6500	94.1
12	0.1025	2.0000	94.9
13	0.1955	3.0000	93.5
TH	0.0000	19.5000	100.0
PWH	0.0000	33.0000	100.0

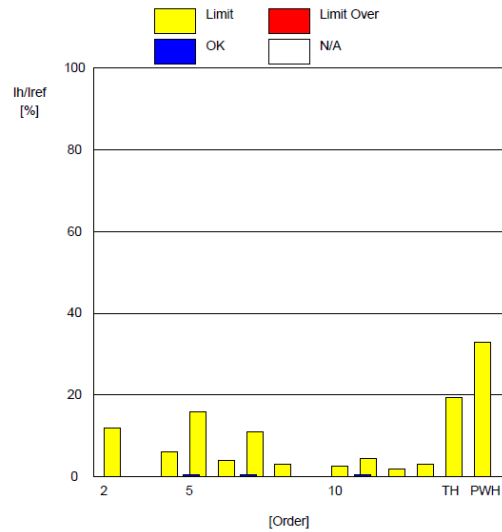
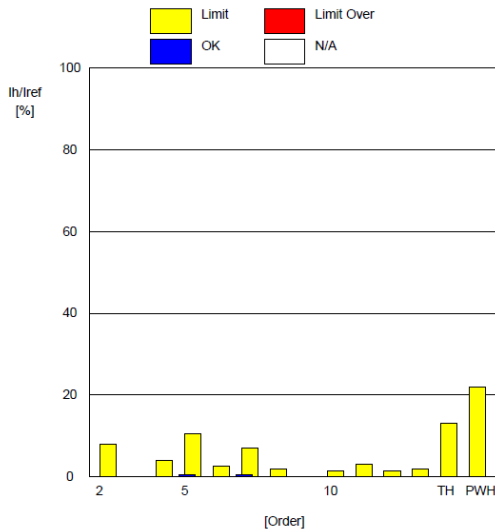



Test Report No.: CE2312WDG0186

AC 400V 50% Load:

Regulation	:	IEC61000-3-12 Ed2.0
	:	IEC61000-4-7 Ed2.0 A1
MeasureTime	:	150sec
Model	:	YOKOGAWA WT3000
Wiring	:	3P4W(3P:three-phase)
Element	:	1
Range	:	300V/200.0A
Rating Voltage	:	400 V
I _{equ}	:	15.0000 A
Z Impedance	:	0.2400 ohm
I _{ref}	:	83.1690 A
Set I _{ref}	:	-----
Power Rsce	:	64.150
Max Rsce	:	33.000

PASS

Ssc	:	342946.06
Min Rsce	:	33.0000
Apply Limit	:	Table3-Balanced 3-phase
Circumstance a	:	0.17% (Pass)
Term a(I5)	:	0.13% (Pass)
Term a(I7)	:	0.23% (Pass)
Term c	:	2.38 - 359.85deg (Fail)
Term d(I5)	:	0.13% (Pass)
Term d(I7)	:	0.23% (Pass)
Term f	:	2.38 - 359.85deg (Fail)

[Average]	:	
Voltage(rms)	:	230.54 V
Current(rms)	:	83.17 A
Frequency	:	50.01 Hz
Power Factor	:	1.00
Sigma W	:	57381.77 W
THC	:	0.74 A
V THD	:	1.50 %
A THD	:	0.90 %
P THD	:	0.00 %

[Maximum]	:	
Voltage(rms)	:	233.22 V
Current(rms)	:	83.42 A
Frequency	:	50.39 Hz
Power Factor	:	1.00
Sigma W	:	58130.21 W
THC	:	0.78 A
V THD	:	1.95 %
A THD	:	0.99 %
P THD	:	0.00 %

Order	Measure[%]	Limit[%]	Margin[%]
2	0.2047	8.0000	97.4
3	0.1252	-----	-----
4	0.1144	4.0000	97.1
5	0.1153	10.7000	98.9
6	0.1018	2.6667	96.2
7	0.1400	7.2000	98.1
8	0.0808	2.0000	96.0
9	0.1350	-----	-----
10	0.0889	1.6000	94.5
11	0.1916	3.1000	93.8
12	0.0557	1.3333	95.8
13	0.1822	2.0000	90.9
TH	0.0000	13.0000	100.0
PWH	0.0000	22.0000	100.0

Order	Measure[%]	Limit[%]	Margin[%]
2	0.2511	12.0000	97.9
3	0.1692	-----	-----
4	0.1381	6.0000	97.7
5	0.1321	16.0500	99.2
6	0.1176	4.0000	97.1
7	0.2266	10.8000	97.9
8	0.1064	3.0000	96.5
9	0.1798	-----	-----
10	0.1269	2.4000	94.7
11	0.2129	4.6500	95.4
12	0.0738	2.0000	96.3
13	0.2201	3.0000	92.7
TH	0.0000	19.5000	100.0
PWH	0.0000	33.0000	100.0

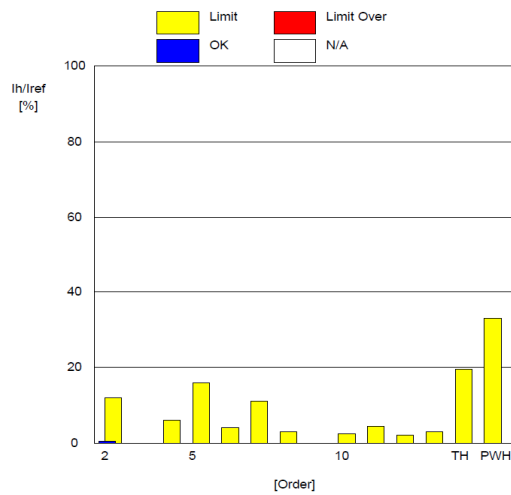
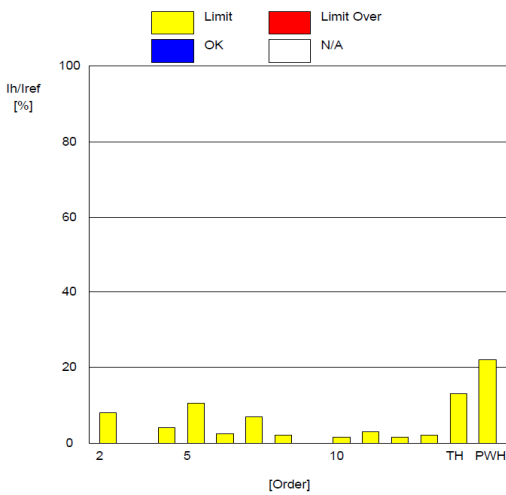

Bureau Veritas Shenzhen Co., Ltd.
Dongguan Branch

No. 96, Guantai Road (Houjie Section), Houjie
Town, Dongguan City, Guangdong Province.
523942. People's Republic of China

Tel: +86 769 8998 2098
Fax: +86 769 8593 1080
Email: customerservice.dg@bureauveritas.com



BUREAU VERITAS

Test Report No.: CE2312WDG0186

Regulation : IEC61000-3-12 Ed2.0
 IEC61000-4-7 Ed2.0 A1
 MeasureTime : 150sec
 Model : YOKOGAWA WT3000
 Wiring : 3P4W(3P:three-phase)
 Element : 2
 Range : 300V/200.0A
 Rating Voltage : 400 V
 I_{eq} : 15.0000 A
 Z Impedance : 0.2400 ohm
 I_{ref} : 82.5575 A
 Set I_{ref} : -----
 Power R_{sce} : 64.150
 Max R_{sce} : 33.000

PASS

Ssc : 342946.06
 Min R_{sce} : 33.0000
 Apply Limit : Table3-Balanced 3-phase
 Circumstance a : 0.23% (Pass)
 Term a(I5) : 0.13% (Pass)
 Term a(I7) : 0.14% (Pass)
 Term c : 0.05 - 359.99deg (Fail)
 Term d(I5) : 0.13% (Pass)
 Term d(I7) : 0.14% (Pass)
 Term f : 0.05 - 359.99deg (Fail)

[Average]
 Voltage(rms) : 229.42 V
 Current(rms) : 82.56 A
 Frequency : 50.01 Hz
 Power Factor : 1.00
 Sigma W : 57381.77 W
 THC : 0.56 A
 V THD : 1.52 %
 A THD : 0.69 %
 P THD : 0.00 %

[Maximum]
 Voltage(rms) : 232.58 V
 Current(rms) : 82.81 A
 Frequency : 50.39 Hz
 Power Factor : 1.00
 Sigma W : 58130.21 W
 THC : 0.60 A
 V THD : 1.99 %
 A THD : 0.78 %
 P THD : 0.00 %

Order	Measure[%]	Limit[%]	Margin[%]
2	0.1618	8.0000	98.0
3	0.1755	-----	-----
4	0.1142	4.0000	97.1
5	0.1040	10.7000	99.0
6	0.1009	2.6667	96.2
7	0.0851	7.2000	98.8
8	0.0840	2.0000	95.8
9	0.0986	-----	-----
10	0.0833	1.6000	94.8
11	0.1121	3.1000	96.4
12	0.0553	1.3333	95.9
13	0.0837	2.0000	95.8
TH	0.0000	13.0000	100.0
PWH	0.0000	22.0000	100.0

Order	Measure[%]	Limit[%]	Margin[%]
2	0.2054	12.0000	98.3
3	0.2311	-----	-----
4	0.1397	6.0000	97.7
5	0.1265	16.0500	99.2
6	0.1143	4.0000	97.1
7	0.1396	10.8000	98.7
8	0.1162	3.0000	96.1
9	0.1236	-----	-----
10	0.1082	2.4000	95.5
11	0.1518	4.6500	96.7
12	0.0826	2.0000	95.9
13	0.1032	3.0000	96.6
TH	0.0000	19.5000	100.0
PWH	0.0000	33.0000	100.0

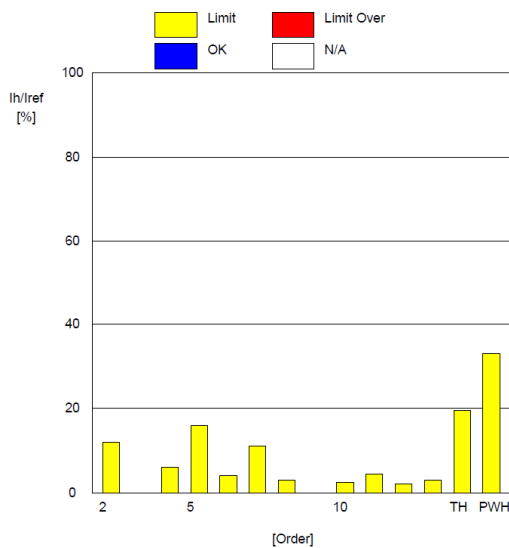
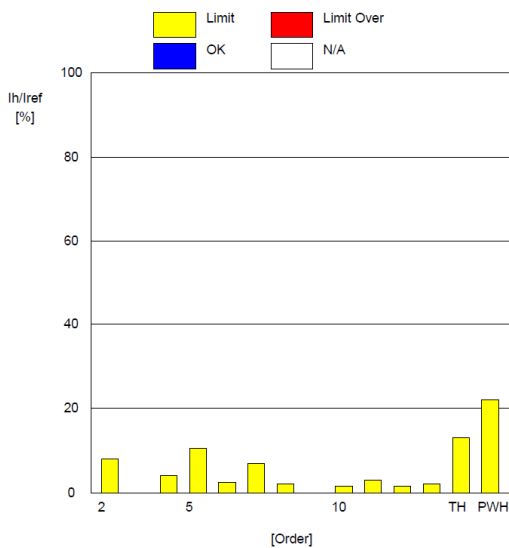

Bureau Veritas Shenzhen Co., Ltd.
Dongguan Branch

No. 96, Guantai Road (Houjie Section), Houjie
 Town, Dongguan City, Guangdong Province.
 523942. People's Republic of China

Tel: +86 769 8998 2098
 Fax: +86 769 8593 1080
 Email: customerservice.dg@bureauveritas.com



BUREAU VERITAS

Test Report No.: CE2312WDG0186

Regulation : IEC61000-3-12 Ed2.0
 IEC61000-4-7 Ed2.0 A1
 MeasureTime : 150sec
 Model : YOKOGAWA WT3000
 Wiring : 3P4W(3P:three-phase)
 Element : 3
 Range : 300V/200.0A
 Rating Voltage : 400 V
 I_{eq} : 15.0000 A
 Z Impedance : 0.2400 ohm
 I_{ref} : 83.1817 A
 Set I_{ref} : -----
 Power R_{sce} : 64.150
 Max R_{sce} : 33.000

PASS

Ssc : 342946.06
 Min R_{sce} : 33.0000
 Apply Limit : Table3-Balanced 3-phase
 Circumstance a : 0.29% (Pass)
 Term a(I5) : 0.12% (Pass)
 Term a(I7) : 0.20% (Pass)
 Term c : 0.27 - 359.91deg (Fail)
 Term d(I5) : 0.12% (Pass)
 Term d(I7) : 0.20% (Pass)
 Term f : 0.27 - 359.91deg (Fail)

[Average]
 Voltage(rms) : 231.78 V
 Current(rms) : 83.18 A
 Frequency : 50.01 Hz
 Power Factor : 1.00
 Sigma W : 57381.77 W
 THC : 0.70 A
 V THD : 1.50 %
 A THD : 0.85 %
 P THD : 0.00 %

[Maximum]
 Voltage(rms) : 233.82 V
 Current(rms) : 83.43 A
 Frequency : 50.39 Hz
 Power Factor : 1.00
 Sigma W : 58130.21 W
 THC : 0.75 A
 V THD : 2.00 %
 A THD : 0.96 %
 P THD : 0.00 %

Order	Measure[%]	Limit[%]	Margin[%]
2	0.1616	8.0000	98.0
3	0.2045	-----	-----
4	0.1251	4.0000	96.9
5	0.1034	10.7000	99.0
6	0.0961	2.6667	96.4
7	0.1204	7.2000	98.3
8	0.0809	2.0000	96.0
9	0.1005	-----	-----
10	0.0902	1.6000	94.4
11	0.2024	3.1000	93.5
12	0.0557	1.3333	95.8
13	0.1420	2.0000	92.9
TH	0.0000	13.0000	100.0
PWH	0.0000	22.0000	100.0

Order	Measure[%]	Limit[%]	Margin[%]
2	0.2074	12.0000	98.3
3	0.2948	-----	-----
4	0.1494	6.0000	97.5
5	0.1193	16.0500	99.3
6	0.1114	4.0000	97.2
7	0.2002	10.8000	98.1
8	0.1092	3.0000	96.4
9	0.1222	-----	-----
10	0.1313	2.4000	94.5
11	0.2294	4.6500	95.1
12	0.0883	2.0000	95.6
13	0.1681	3.0000	94.4
TH	0.0000	19.5000	100.0
PWH	0.0000	33.0000	100.0

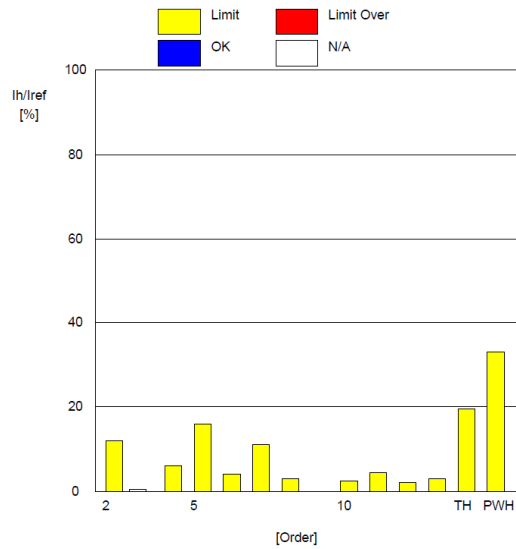
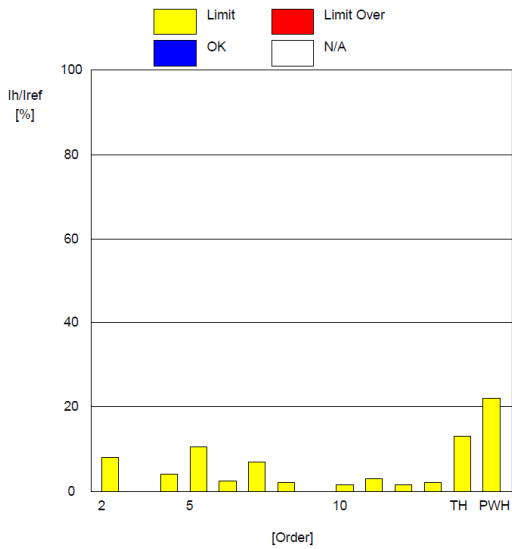

**Bureau Veritas Shenzhen Co., Ltd.
 Dongguan Branch**

No. 96, Guantai Road (Houjie Section), Houjie
 Town, Dongguan City, Guangdong Province.
 523942. People's Republic of China

Tel: +86 769 8998 2098
 Fax: +86 769 8593 1080
 Email: customerservice.dg@bureauveritas.com



BUREAU VERITAS

Test Report No.: CE2312WDG0186

AC 400V Full Load:

Regulation : IEC61000-3-12 Ed2.0
 IEC61000-4-7 Ed2.0 A1
 MeasureTime : 150sec
 Model : YOKOGAWA WT3000
 Wiring : 3P4W(3P:three-phase)
 Element : 1
 Range : 300V/200.0A
 Rating Voltage : 400 V
 I_{eq} : 15.0000 A
 Z Impedance : 0.2400 ohm
 I_{ref} : 166.5568 A
 Set I_{ref} : -----
 Power R_{sce} : 64.150
 Max R_{sce} : 33.000

PASS

Ssc : 342946.06
 Min R_{sce} : 33.0000
 Apply Limit : Table3-Balanced 3-phase
 Circumstance a : 0.37% (Pass)
 Term a(I5) : 0.08% (Pass)
 Term a(I7) : 0.09% (Pass)
 Term c : 0.06 - 359.25deg (Fail)
 Term d(I5) : 0.08% (Pass)
 Term d(I7) : 0.09% (Pass)
 Term f : 0.06 - 359.25deg (Fail)

[Average]
 Voltage(rms) : 230.82 V
 Current(rms) : 166.56 A
 Frequency : 50.00 Hz
 Power Factor : 1.00
 Sigma W : 115073.8 W
 THC : 1.31 A
 V THD : 1.43 %
 A THD : 0.79 %
 P THD : 0.00 %

[Maximum]
 Voltage(rms) : 233.31 V
 Current(rms) : 167.13 A
 Frequency : 50.36 Hz
 Power Factor : 1.00
 Sigma W : 116655.5 W
 THC : 1.37 A
 V THD : 2.10 %
 A THD : 0.84 %
 P THD : 0.01 %

Order	Measure[%]	Limit[%]	Margin[%]
2	0.1983	8.0000	97.5
3	0.3516	-----	-----
4	0.0779	4.0000	98.1
5	0.0638	10.7000	99.4
6	0.0297	2.6667	98.9
7	0.0456	7.2000	99.4
8	0.0377	2.0000	98.1
9	0.1016	-----	-----
10	0.0459	1.6000	97.1
11	0.0948	3.1000	96.9
12	0.0518	1.3333	96.1
13	0.0488	2.0000	97.6
TH	0.0000	13.0000	100.0
PWH	0.0000	22.0000	100.0

Order	Measure[%]	Limit[%]	Margin[%]
2	0.2170	12.0000	98.2
3	0.3721	-----	-----
4	0.0914	6.0000	98.5
5	0.0784	16.0500	99.5
6	0.0401	4.0000	99.0
7	0.0921	10.8000	99.1
8	0.0511	3.0000	98.3
9	0.1249	-----	-----
10	0.0642	2.4000	97.3
11	0.1167	4.6500	97.5
12	0.0628	2.0000	96.9
13	0.0690	3.0000	97.7
TH	0.0000	19.5000	100.0
PWH	0.0000	33.0000	100.0

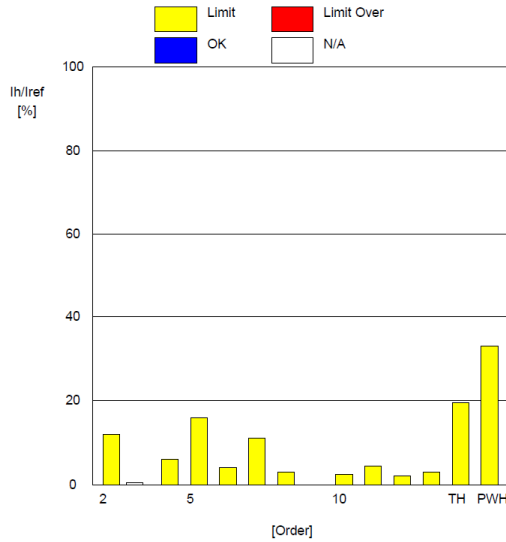
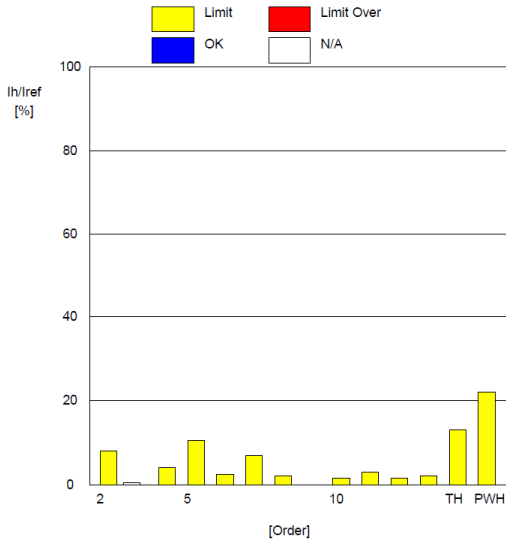

Bureau Veritas Shenzhen Co., Ltd.
 Dongguan Branch

No. 96, Guantai Road (Houjie Section), Houjie
 Town, Dongguan City, Guangdong Province.
 523942. People's Republic of China

Tel: +86 769 8998 2098
 Fax: +86 769 8593 1080
 Email: customerservice.dg@bureauveritas.com



BUREAU VERITAS

Test Report No.: CE2312WDG0186

Regulation : IEC61000-3-12 Ed2.0
 IEC61000-4-7 Ed2.0 A1
 MeasureTime : 150sec
 Model : YOKOGAWA WT3000
 Wiring : 3P4W(3P:three-phase)
 Element : 2
 Range : 300V/200.0A
 Rating Voltage : 400 V
 I_{eq} : 15.0000 A
 Z Impedance : 0.2400 ohm
 I_{ref} : 165.8168 A
 Set I_{ref} : -----
 Power R_{sce} : 64.150
 Max R_{sce} : 33.000

PASS

Ssc : 342946.06
 Min R_{sce} : 33.0000
 Apply Limit : Table3-Balanced 3-phase
 Circumstance a : 0.26% (Pass)
 Term a(I5) : 0.15% (Pass)
 Term a(I7) : 0.07% (Pass)
 Term c : 0.00 - 360.00deg (Fail)
 Term d(I5) : 0.15% (Pass)
 Term d(I7) : 0.07% (Pass)
 Term f : 0.00 - 360.00deg (Fail)

[Average]
 Voltage(rms) : 230.01 V
 Current(rms) : 165.82 A
 Frequency : 50.00 Hz
 Power Factor : 1.00
 Sigma W : 115073.8 W
 THC : 1.04 A
 V THD : 1.46 %
 A THD : 0.63 %
 P THD : 0.00 %

[Maximum]
 Voltage(rms) : 232.61 V
 Current(rms) : 166.34 A
 Frequency : 50.36 Hz
 Power Factor : 1.00
 Sigma W : 116655.5 W
 THC : 1.10 A
 V THD : 2.13 %
 A THD : 0.70 %
 P THD : 0.00 %

Order	Measure[%]	Limit[%]	Margin[%]
2	0.1283	8.0000	98.4
3	0.2329	-----	-----
4	0.0415	4.0000	99.0
5	0.1290	10.7000	98.8
6	0.0367	2.6667	98.6
7	0.0579	7.2000	99.2
8	0.0343	2.0000	98.3
9	0.1109	-----	-----
10	0.0499	1.6000	96.9
11	0.0887	3.1000	97.1
12	0.0469	1.3333	96.5
13	0.0391	2.0000	98.1
TH	0.0000	13.0000	100.0
PWH	0.0000	22.0000	100.0

Order	Measure[%]	Limit[%]	Margin[%]
2	0.1459	12.0000	98.8
3	0.2621	-----	-----
4	0.0502	6.0000	99.2
5	0.1461	16.0500	99.1
6	0.0488	4.0000	98.8
7	0.0693	10.8000	99.4
8	0.0454	3.0000	98.5
9	0.1357	-----	-----
10	0.0607	2.4000	97.5
11	0.1075	4.6500	97.7
12	0.0562	2.0000	97.2
13	0.0516	3.0000	98.3
TH	0.0000	19.5000	100.0
PWH	0.0000	33.0000	100.0

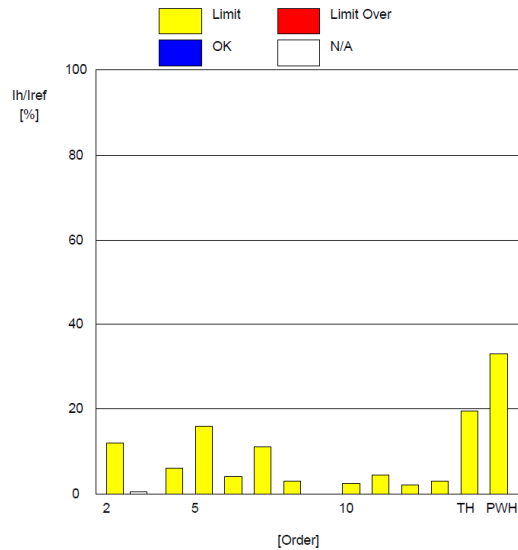
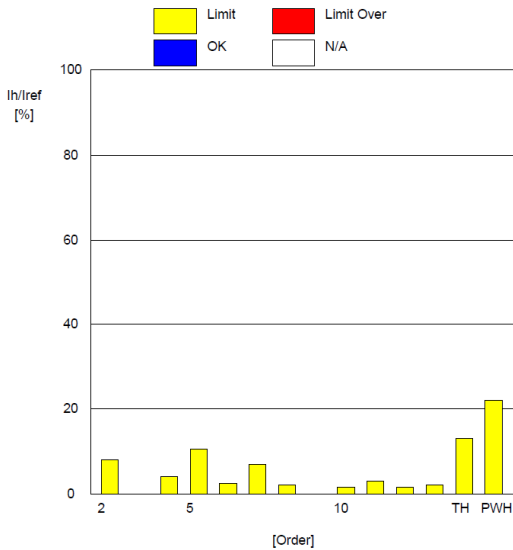

Bureau Veritas Shenzhen Co., Ltd.
 Dongguan Branch

No. 96, Guantai Road (Houjie Section), Houjie
 Town, Dongguan City, Guangdong Province.
 523942. People's Republic of China

Tel: +86 769 8998 2098
 Fax: +86 769 8593 1080
 Email: customerservice.dg@bureauveritas.com



BUREAU VERITAS

Test Report No.: CE2312WDG0186

Regulation : IEC61000-3-12 Ed2.0
 IEC61000-4-7 Ed2.0 A1
 MeasureTime : 150sec
 Model : YOKOGAWA WT3000
 Wiring : 3P4W(3P:three-phase)
 Element : 3
 Range : 300V/200.0A
 Rating Voltage : 400 V
 I_{equ} : 15.0000 A
 Z Impedance : 0.2400 ohm
 I_{ref} : 166.3734 A
 Set I_{ref} : -----
 Power Rsce : 64.150
 Max Rsce : 33.000

PASS

Ssc : 342946.06
 Min Rsce : 33.0000
 Apply Limit : Table3-Balanced 3-phase
 Circumstance a : 0.27% (Pass)
 Term a(I5) : 0.19% (Pass)
 Term a(I7) : 0.11% (Pass)
 Term c : 23.09 - 55.20deg (Fail)
 Term d(I5) : 0.19% (Pass)
 Term d(I7) : 0.11% (Pass)
 Term f : 23.09 - 55.20deg (Fail)

[Average]

Voltage(rms) : 231.48 V
 Current(rms) : 166.37 A
 Frequency : 50.00 Hz
 Power Factor : 1.00
 Sigma W : 115073.8 W
 THC : 1.18 A
 V THD : 1.44 %
 A THD : 0.71 %
 P THD : 0.00 %

[Maximum]

Voltage(rms) : 233.87 V
 Current(rms) : 166.88 A
 Frequency : 50.36 Hz
 Power Factor : 1.00
 Sigma W : 116655.5 W
 THC : 1.32 A
 V THD : 2.12 %
 A THD : 0.84 %
 P THD : 0.00 %

Order	Measure[%]	Limit[%]	Margin[%]
2	0.1161	8.0000	98.5
3	0.2416	-----	-----
4	0.0826	4.0000	97.9
5	0.1381	10.7000	98.7
6	0.0321	2.6667	98.8
7	0.0748	7.2000	99.0
8	0.0326	2.0000	98.4
9	0.0792	-----	-----
10	0.0463	1.6000	97.1
11	0.1275	3.1000	95.9
12	0.0513	1.3333	96.2
13	0.0358	2.0000	98.2
TH	0.0000	13.0000	100.0
PWH	0.0000	22.0000	100.0

Order	Measure[%]	Limit[%]	Margin[%]
2	0.1326	12.0000	98.9
3	0.2670	-----	-----
4	0.0938	6.0000	98.4
5	0.1857	16.0500	98.8
6	0.0409	4.0000	99.0
7	0.1113	10.8000	99.0
8	0.0395	3.0000	98.7
9	0.0964	-----	-----
10	0.0579	2.4000	97.6
11	0.1553	4.6500	96.7
12	0.0637	2.0000	96.8
13	0.0519	3.0000	98.3
TH	0.0000	19.5000	100.0
PWH	0.0000	33.0000	100.0

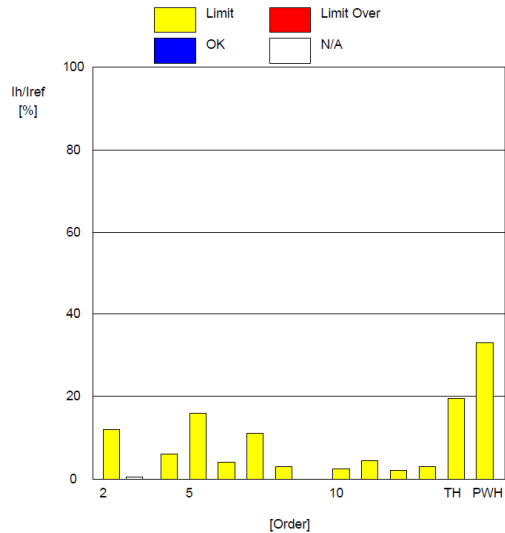
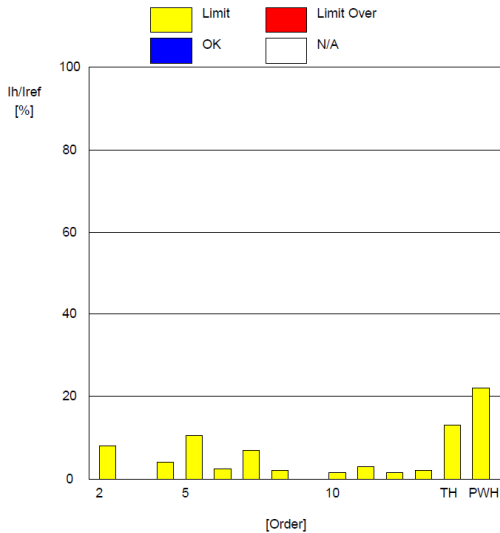

Bureau Veritas Shenzhen Co., Ltd.
Dongguan Branch

No. 96, Guantai Road (Houjie Section), Houjie
 Town, Dongguan City, Guangdong Province.
 523942, People's Republic of China

Tel: +86 769 8998 2098
 Fax: +86 769 8593 1080
 Email: customerservice.dg@bureauveritas.com



3.5 VOLTAGE FLUCTUATION AND FLICKS MEASUREMENT

3.5.1 LIMITS OF VOLTAGE FLUCTUATION AND FLICKS MEASUREMENT

TEST STANDARD: EN IEC 61000-3-11

TEST ITEM	LIMIT	NOTE
P_{st}	1.0	P_{st} means short-term flicker indicator.
P_{lt}	0.65	P_{lt} means long-term flicker indicator.
$T_{d(t)}$ (ms)	500	$T_{d(t)}$ means maximum time that $d(t)$ exceeds 3.3%.
d_{max} (%)	4	d_{max} means maximum relative voltage change.
dc (%)	3.3	dc means relative steady-state voltage change

TEST STANDARD: EN IEC 61000-3-11

The test conditions specified in Annex A of EN IEC 61000-3-3 shall be applicable to equipment rated $\leq 16A$

The test impedance Z_{test} may be lower than Z_{ref} , particularly for equipment having a rated input current $>16 A$. To find the optimal test impedance, two conditions shall be met.

- firstly, the voltage drop, ΔU , caused by the equipment shall be within the range 3 % to 5 % of the test supply voltage;
- secondly, the ratio of inductive to resistive components of Z_{test} given by X_{test} / R_{test} shall be within the range 0,5 to 0,75 (i.e. similar to the ratio of the components of Z_{ref}).

NOTE The 3 % to 5 % condition ensures that the relative current changes of the equipment in the real network situation will be nearly the same as those during the test.

The test shall be made with the test circuit specified in Figure 1, except that the impedance Z_{ref} is replaced with Z_{test} . Four values $d_{c\ test}$, $d_{max\ test}$, $P_{st\ test}$ and $P_{lt\ test}$ shall be measured. The definitions of d_c , d_{max} , P_{st} , and P_{lt} are given in IEC 61000-3-3.



3.5.2 TEST INSTRUMENTS

Description	Manufacturer	Model no.	Serial No.	Last Cal.	Next Cal.
Power Analyzer	YOKOGAWA	WT3000	91J902079	2019/02/19	2020/02/18
Power Analyzer	HIOKI	PW6001	170200696	2019/02/21	2020/02/20
Programmable DC source	Keysight	N8957APV	DE16391780	2018/12/20	2019/12/19
Programmable DC source	Keysight	N8957APV	DE16391779	2018/12/20	2019/12/19
Programmable DC source	Keysight	N8957APV	DE16391778	2018/12/20	2019/12/19
Programmable DC source	Keysight	N8957APV	DE16321623	2018/12/20	2019/12/19
Programmable DC source	Keysight	N8957APV	DE16321622	2018/12/20	2019/12/19
Programmable DC source	Keysight	N8957APV	DE16341673	2018/12/20	2019/12/19
Programmable DC source	Keysight	N8957APV	DE16341669	2018/12/20	2019/12/19
Programmable DC source	Keysight	N8957APV	DE16341674	2018/12/20	2019/12/19
Programmable DC source	Keysight	N8957APV	DE16341675	2018/12/20	2019/12/19
Programmable DC source	Keysight	N8957APV	DE16341670	2018/12/20	2019/12/19
Programmable DC source	Keysight	N8957APV	DE16341672	2018/12/20	2019/12/19
Programmable DC source	Keysight	N8957APV	DE16321625	2018/12/20	2019/12/19
Programmable DC source	Keysight	N8957APV	DE16321626	2018/12/20	2019/12/19
Programmable DC source	Keysight	N8957APV	DE16321627	2018/12/20	2019/12/19
AC Source	Ametek	RS90-3PI	1515A00638	2019/04/07	2020/04/06
AC Source	Ametek	RS90-3PI	1623A00088	2018/12/20	2019/12/19
Oscillographic recorder	YOKOGAWA	DL850	91LA25621	2019/04/04	2020/04/03
Oscillographic recorder	Tektronix	DPO7054	C010429	2019/04/07	2020/04/06
Electric current transducer	HIOKI	CT6863	140201351	2019/02/24	2020/02/23
Electric current transducer	HIOKI	CT6863	140201344	2019/02/24	2020/02/23
Electric current transducer	HIOKI	CT6863	140201347	2019/02/24	2020/02/23



Description	Manufacturer	Model no.	Serial No.	Last Cal.	Next Cal.
Power analyzer	YOKOGAWA	WT3000	91J902079	2022/05/21	2023/05/20
Current sensor	HIOKI	CT9555/CT6863	170333301	2021/12/31	2022/12/3
Current sensor	HIOKI	CT9555/CT6862-05	170239123/17 0342413	2021/12/31	2022/12/30
Current sensor	HIOKI	CT9555/CT6863	170234315/16 0922604	2021/12/31	2022/12/30

NOTE: 1.The test was performed by witness in H/F Room of ShangHai Huawei Technology Co., Ltd.
2. The test was performed in Harmonics Room.

3.5.3 TEST PROCEDURE

- a. The EUT was placed on the top of a wooden table 0.8 meters above the ground and operated to produce the most unfavorable sequence of voltage changes under Normal Operating conditions.
- b. During the flick measurement, the measure time shall include that part of whole operation cycle in which the EUT produce the most unfavorable sequence of voltage changes. The observation period for short-term flicker indicator is 120 minutes

3.5.4 DEVIATION FROM TEST STANDARD

No deviation



3.5.5 TEST SETUP

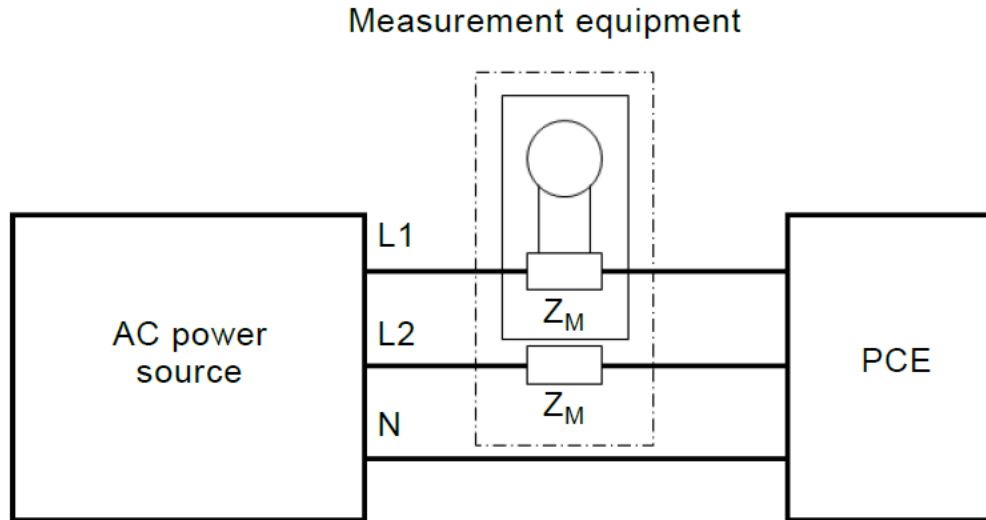

IEC

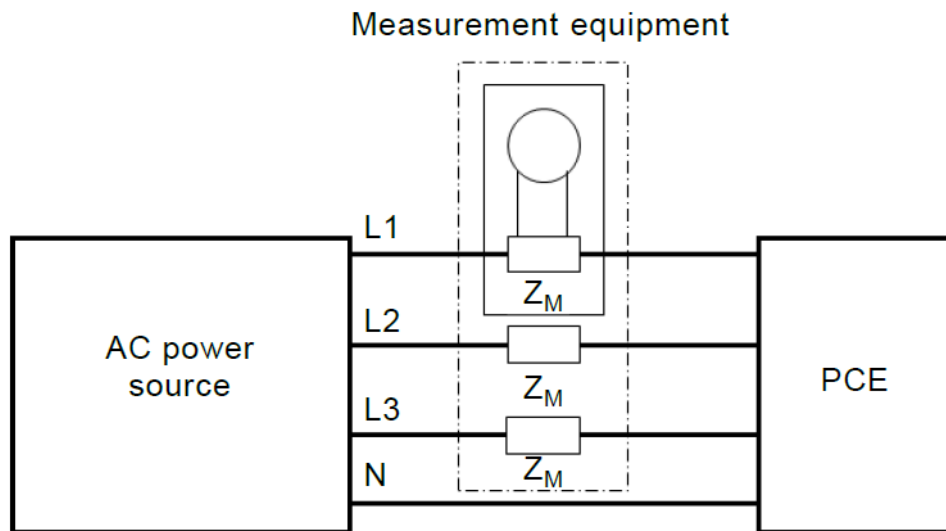

IEC

3.5.6 EUT OPERATING CONDITIONS

Same as item 3.1.6.



3.5.7 TEST RESULTS

SUN2000-100KTL-M1 AC 400V:

Regulation : IEC61000-3-11 Ed1.0
 IEC61000-4-15 Ed2.0
 Interval : 10Min0Sec
 Model : YOKOGAWA WT3000
 Impedance : 0.24+j0.15
 Wiring : three-phase 4wire
 Voltage Range : 1000.00V
 Set Voltage : 230V
 Set Frequency : 50Hz
 Voltage U1 : 230.00V
 Frequency U1 : 50.002Hz
 Element : 1
 dmin : 0.20%

PASS (Under dmin)

Compatibility Condition : Compliance with IEC61000-3-3(Ztest)
 Element1 : Pass(Under dmin)
 dc (3.30%) : Pass
 dmax(4.00%) : Pass
 d(t) (500ms) : ----
 Pst (1.00) : Pass
 Plt (0.65) : Pass

No.	dc[%]	dmax[%]	d(t)[ms]	Pst
1	0.00	0.00	----	0.15
2	0.00	0.00	----	0.13
3	0.00	0.00	----	0.13
4	0.00	0.00	----	0.14
5	0.00	0.00	----	0.13
6	0.00	0.00	----	0.13
7	0.00	0.00	----	0.13
8	0.00	0.00	----	0.13
9	0.00	0.00	----	0.14
10	0.00	0.00	----	0.14
11	0.00	0.00	----	0.14
12	0.00	0.00	----	0.14

Plt
0.14

Regulation : IEC61000-3-11 Ed1.0
 IEC61000-4-15 Ed2.0
 Interval : 10Min0Sec
 Model : YOKOGAWA WT3000
 Impedance : 0.24+j0.15
 Wiring : three-phase 4wire
 Voltage Range : 1000.00V
 Set Voltage : 230V
 Set Frequency : 50Hz
 Voltage U2 : 230.00V
 Frequency U2 : 50.002Hz
 Element : 2
 dmin : 0.20%

PASS (Under dmin)

Compatibility Condition : Compliance with IEC61000-3-3(Ztest)
 Element2 : Pass(Under dmin)
 dc (3.30%) : Pass
 dmax(4.00%) : Pass
 d(t) (500ms) : ----
 Pst (1.00) : Pass
 Plt (0.65) : Pass

No.	dc[%]	dmax[%]	d(t)[ms]	Pst
1	0.00	0.00	----	0.20
2	0.00	0.00	----	0.20
3	0.00	0.00	----	0.20
4	0.00	0.00	----	0.22
5	0.00	0.00	----	0.18
6	0.00	0.00	----	0.15
7	0.00	0.00	----	0.16
8	0.00	0.00	----	0.17
9	0.00	0.00	----	0.18
10	0.00	0.00	----	0.18
11	0.00	0.00	----	0.18
12	0.00	0.00	----	0.17

Plt
0.18



**BUREAU
VERITAS**

Test Report No.: CE2312WDG0186

Regulation : IEC61000-3-11 Ed1.0
 IEC61000-4-15 Ed2.0
 Interval : 10Min0Sec
 Model : YOKOGAWA WT3000
 Impedance : 0.24+j0.15
 Wiring : three-phase 4wire
 Voltage Range : 1000.00V
 Set Voltage : 230V
 Set Frequency : 50Hz
 Voltage U3 : 230.00V
 Frequency U3 : Error
 Element : 3
 dmin : 0.20%

PASS
(Under dmin)

Compatibility Condition : Compliance with IEC61000-3-3(Ztest)
 Element3 : Pass(Under dmin)
 dc (3.30%) : Pass
 dmax(4.00%) : Pass
 d(t) (500ms) : ----
 Pst (1.00) : Pass
 Plt (0.65) : Pass

No.	dc[%]	dmax[%]	d(t)[ms]	Pst
1	0.00	0.00	----	0.18
2	0.00	0.00	----	0.18
3	0.00	0.00	----	0.17
4	0.00	0.00	----	0.19
5	0.00	0.00	----	0.16
6	0.00	0.00	----	0.15
7	0.00	0.00	----	0.16
8	0.00	0.00	----	0.16
9	0.00	0.00	----	0.17
10	0.00	0.00	----	0.17
11	0.00	0.00	----	0.17
12	0.00	0.00	----	0.16
				Plt
				0.17

AC 480V:

Regulation : IEC61000-3-11 Ed1.0
 IEC61000-4-15 Ed2.0
 Interval : 10Min0Sec
 Model : YOKOGAWA WT3000
 Impedance : 0.24+j0.15
 Wiring : three-phase 4wire
 Voltage Range : 1000.00V
 Set Voltage : 230V
 Set Frequency : 50Hz
 Voltage U1 : 277.00V
 Frequency U1 : 50.001Hz
 Element : 1
 dmin : 0.20%

PASS
(Under dmin)

Compatibility Condition : Compliance with IEC61000-3-3(Ztest)
 Element1 : Pass(Under dmin)
 dc (3.30%) : Pass
 dmax(4.00%) : Pass
 d(t) (500ms) : ----
 Pst (1.00) : Pass
 Plt (0.65) : Pass

No.	dc[%]	dmax[%]	d(t)[ms]	Pst
1	0.00	0.00	----	0.11
2	0.00	0.00	----	0.10
3	0.00	0.00	----	0.10
4	0.00	0.00	----	0.10
5	0.00	0.00	----	0.11
6	0.00	0.00	----	0.12
7	0.00	0.00	----	0.11
8	0.00	0.00	----	0.12
9	0.00	0.00	----	0.12
10	0.00	0.00	----	0.12
11	0.00	0.00	----	0.11
12	0.00	0.00	----	0.11
				Plt
				0.11

**Bureau Veritas Shenzhen Co., Ltd.
Dongguan Branch**

No. 96, Guantai Road (Houjie Section), Houjie
 Town, Dongguan City, Guangdong Province.
 523942. People's Republic of China

Tel: +86 769 8998 2098
 Fax: +86 769 8593 1080
 Email: customerservice.dg@bureauveritas.com



**BUREAU
VERITAS**

Test Report No.: CE2312WDG0186

Regulation : IEC61000-3-11 Ed1.0
 IEC61000-4-15 Ed2.0
 Interval : 10Min0Sec
 Model : YOKOGAWA WT3000
 Impedance : 0.24+j0.15
 Wiring : three-phase 4wire
 Voltage Range : 1000.00V
 Set Voltage : 230V
 Set Frequency : 50Hz
 Voltage U2 : 277.00V
 Frequency U2 : 50.001Hz
 Element : 2
 dmin : 0.20%

PASS
(Under dmin)

Compatibility Condition : Compliance with IEC61000-3-3(Ztest)
 Element2 : Pass(Under dmin)
 dc (3.30%) : Pass
 dmax(4.00%) : Pass
 d(t) (500ms) : -----
 Pst (1.00) : Pass
 Plt (0.65) : Pass

No.	dc[%]	dmax[%]	d(t)[ms]	Pst
1	0.00	0.00	----	0.14
2	0.00	0.00	----	0.14
3	0.00	0.00	----	0.13
4	0.00	0.00	----	0.14
5	0.00	0.00	----	0.14
6	0.00	0.00	----	0.15
7	0.00	0.00	----	0.12
8	0.00	0.00	----	0.15
9	0.00	0.00	----	0.16
10	0.00	0.00	----	0.16
11	0.00	0.00	----	0.15
12	0.00	0.00	----	0.13

Plt
0.14

Regulation : IEC61000-3-11 Ed1.0
 IEC61000-4-15 Ed2.0
 Interval : 10Min0Sec
 Model : YOKOGAWA WT3000
 Impedance : 0.24+j0.15
 Wiring : three-phase 4wire
 Voltage Range : 1000.00V
 Set Voltage : 230V
 Set Frequency : 50Hz
 Voltage U3 : 277.00V
 Frequency U3 : Error
 Element : 3
 dmin : 0.20%

PASS
(Under dmin)

Compatibility Condition : Compliance with IEC61000-3-3(Ztest)
 Element3 : Pass(Under dmin)
 dc (3.30%) : Pass
 dmax(4.00%) : Pass
 d(t) (500ms) : -----
 Pst (1.00) : Pass
 Plt (0.65) : Pass

No.	dc[%]	dmax[%]	d(t)[ms]	Pst
1	0.00	0.00	----	0.12
2	0.00	0.00	----	0.12
3	0.00	0.00	----	0.12
4	0.00	0.00	----	0.12
5	0.00	0.00	----	0.12
6	0.00	0.00	----	0.13
7	0.04	0.28	----	0.11
8	0.02	0.31	----	0.13
9	0.23	0.26	----	0.14
10	0.27	0.32	----	0.14
11	0.27	0.33	----	0.13
12	0.26	0.32	----	0.12

Plt
0.13

**Bureau Veritas Shenzhen Co., Ltd.
Dongguan Branch**

No. 96, Guantai Road (Houjie Section), Houjie
 Town, Dongguan City, Guangdong Province.
 523942. People's Republic of China

Tel: +86 769 8998 2098
 Fax: +86 769 8593 1080
 Email: customerservice.dg@bureauveritas.com



**BUREAU
VERITAS**

Test Report No.: CE2312WDG0186

SUN2000-115KTL-M2 AC 400V 25% Load:

Regulation : IEC61000-3-11 Ed1.0
 : IEC61000-4-15 Ed1.1
 Interval : 10Min0Sec
 Model : YOKOGAWA WT3000
 Impedance : 0.24+j0.15
 Wiring : three-phase 4wire
 Voltage Range : 600.00V
 Set Voltage : ---
 Set Frequency : 50Hz
 Voltage U1 : 228.77V
 Frequency U1 : 50.002Hz
 Element : 1
 dmin : 0.20%

PASS

Compatibility Condition : Compliance with IEC61000-3-3(Ztest)
 Element1 : Pass
 dc (3.30%) : Pass
 dmax(6.00%) : Pass
 d(t) (500ms) : ----
 Pst (1.00) : Pass
 Plt (0.65) : Pass

No.	dc[%]	dmax[%]	d(t)[ms]	Pst
1	1.44	1.46	----	0.22
2	1.30	1.40	----	0.23
3	0.98	1.02	----	0.21
4	1.17	1.26	----	0.13
5	1.42	1.43	----	0.13
6	1.17	1.22	----	0.13
7	1.27	1.32	----	0.13
8	0.47	0.50	----	0.13
9	0.92	0.98	----	0.13
10	0.64	0.70	----	0.13
11	0.53	0.53	----	0.13
12	1.09	1.16	----	0.13

**Plt
0.16**

Regulation : IEC61000-3-11 Ed1.0
 : IEC61000-4-15 Ed1.1
 Interval : 10Min0Sec
 Model : YOKOGAWA WT3000
 Impedance : 0.24+j0.15
 Wiring : three-phase 4wire
 Voltage Range : 600.00V
 Set Voltage : ---
 Set Frequency : 50Hz
 Voltage U2 : 229.15V
 Frequency U2 : 50.004Hz
 Element : 2
 dmin : 0.20%

PASS

Compatibility Condition : Compliance with IEC61000-3-3(Ztest)
 Element2 : Pass
 dc (3.30%) : Pass
 dmax(6.00%) : Pass
 d(t) (500ms) : ----
 Pst (1.00) : Pass
 Plt (0.65) : Pass

No.	dc[%]	dmax[%]	d(t)[ms]	Pst
1	1.75	1.92	----	0.23
2	1.21	1.42	----	0.21
3	0.76	0.92	----	0.22
4	1.03	1.16	----	0.13
5	1.40	1.59	----	0.13
6	1.50	1.65	----	0.13
7	1.24	1.43	----	0.14
8	1.21	1.38	----	0.13
9	0.41	0.57	----	0.14
10	0.24	0.45	----	0.13
11	0.53	0.66	----	0.14
12	1.48	1.68	----	0.13

**Plt
0.16**

**Bureau Veritas Shenzhen Co., Ltd.
Dongguan Branch**

No. 96, Guantai Road (Houjie Section), Houjie
 Town, Dongguan City, Guangdong Province.
 523942. People's Republic of China

Tel: +86 769 8998 2098
 Fax: +86 769 8593 1080
 Email: customerservice.dg@bureauveritas.com



**BUREAU
VERITAS**

Test Report No.: CE2312WDG0186

Regulation : IEC61000-3-11 Ed1.0
 IEC61000-4-15 Ed1.1
 Interval : 10Min0Sec
 Model : YOKOGAWA WT3000
 Impedance : 0.24+j0.15
 Wiring : three-phase 4wire
 Voltage Range : 600.00V
 Set Voltage : ---
 Set Frequency : 50Hz
 Voltage U3 : 233.67V
 Frequency U3 : Error
 Element : 3
 dmin : 0.20%

PASS

Compatibility Condition : Compliance with IEC61000-3-3(Ztest)
 Element3 : Pass
 dc (3.30%) : Pass
 dmax(6.00%) : Pass
 d(t) (500ms) : ----
 Pst (1.00) : Pass
 Plt (0.65) : Pass

No.	dc[%]	dmax[%]	d(t)[ms]	Pst
1	0.97	1.01	----	0.26
2	1.34	1.35	----	0.23
3	0.90	0.95	----	0.22
4	1.14	1.22	----	0.17
5	1.18	1.21	----	0.16
6	1.35	1.40	----	0.14
7	1.37	1.37	----	0.15
8	0.83	0.90	----	0.15
9	1.09	1.13	----	0.15
10	0.41	0.43	----	0.15
11	0.38	0.39	----	0.17
12	1.22	1.23	----	0.17

Plt
0.19

**Bureau Veritas Shenzhen Co., Ltd.
Dongguan Branch**

No. 96, Guantai Road (Houjie Section), Houjie
Town, Dongguan City, Guangdong Province.
523942. People's Republic of China

Tel: +86 769 8998 2098
 Fax: +86 769 8593 1080
 Email: customerservice.dg@bureauveritas.com



SUN2000-115KTL-M2 AC 400V 50% Load:

Regulation : IEC61000-3-11 Ed1.0
 IEC61000-4-15 Ed1.1
 Interval : 10Min0Sec
 Model : YOKOGAWA WT3000
 Impedance : 0.24+j0.15
 Wiring : three-phase 4wire
 Voltage Range : 600.00V
 Set Voltage : ---
 Set Frequency : 50Hz
 Voltage U1 : 233.29V
 Frequency U1 : 50.013Hz
 Element : 1
 dmin : 0.20%

PASS

Compatibility Condition : Compliance with IEC61000-3-3(Ztest)
 Element1 : Pass
 dc (3.30%) : Pass
 dmax(6.00%) : Pass
 d(t) (500ms) : ----
 Pst (1.00) : Pass
 Plt (0.65) : Pass

No.	dc[%]	dmax[%]	d(t)[ms]	Pst
1	1.19	1.21	----	0.21
2	1.37	1.41	----	0.22
3	0.45	0.49	----	0.22
4	1.17	1.24	----	0.20
5	1.63	1.66	----	0.21
6	1.43	1.47	----	0.22
7	1.11	1.17	----	0.21
8	0.88	0.94	----	0.22
9	1.46	1.47	----	0.22
10	1.05	1.13	----	0.21
11	0.82	0.88	----	0.23
12	1.01	1.04	----	0.22

Plt
0.22

Regulation : IEC61000-3-11 Ed1.0
 IEC61000-4-15 Ed1.1
 Interval : 10Min0Sec
 Model : YOKOGAWA WT3000
 Impedance : 0.24+j0.15
 Wiring : three-phase 4wire
 Voltage Range : 600.00V
 Set Voltage : ---
 Set Frequency : 50Hz
 Voltage U2 : 228.19V
 Frequency U2 : 50.000Hz
 Element : 2
 dmin : 0.20%

PASS

Compatibility Condition : Compliance with IEC61000-3-3(Ztest)
 Element2 : Pass
 dc (3.30%) : Pass
 dmax(6.00%) : Pass
 d(t) (500ms) : ----
 Pst (1.00) : Pass
 Plt (0.65) : Pass

No.	dc[%]	dmax[%]	d(t)[ms]	Pst
1	1.17	1.34	----	0.22
2	1.81	2.00	----	0.23
3	0.83	0.91	----	0.20
4	2.08	2.32	----	0.21
5	2.02	2.49	----	0.22
6	2.21	2.49	----	0.21
7	1.91	2.07	----	0.22
8	2.17	2.28	----	0.22
9	2.12	2.45	----	0.21
10	1.84	1.98	----	0.23
11	2.23	2.48	----	0.23
12	2.16	2.31	----	0.21

Plt
0.22

Bureau Veritas Shenzhen Co., Ltd.
Dongguan Branch

No. 96, Guantai Road (Houjie Section), Houjie
 Town, Dongguan City, Guangdong Province.
 523942. People's Republic of China

Tel: +86 769 8998 2098
 Fax: +86 769 8593 1080
 Email: customerservice.dg@bureauveritas.com



**BUREAU
VERITAS**

Test Report No.: CE2312WDG0186

Regulation : IEC61000-3-11 Ed1.0
 IEC61000-4-15 Ed1.1
 Interval : 10Min0Sec
 Model : YOKOGAWA WT3000
 Impedance : 0.24+j0.15
 Wiring : three-phase 4wire
 Voltage Range : 600.00V
 Set Voltage : ---
 Set Frequency : 50Hz
 Voltage U3 : 230.54V
 Frequency U3 : Error
 Element : 3
 dmin : 0.20%

PASS

Compatibility Condition : Compliance with IEC61000-3-3(Ztest)
 Element3 : Pass
 dc (3.30%) : Pass
 dmax(6.00%) : Pass
 d(t) (500ms) : ----
 Pst (1.00) : Pass
 Plt (0.65) : Pass

No.	dc[%]	dmax[%]	d(t)[ms]	Pst
1	1.12	1.21	----	0.22
2	1.42	1.49	----	0.21
3	1.13	1.24	----	0.23
4	0.99	1.05	----	0.23
5	1.42	1.52	----	0.22
6	1.32	1.39	----	0.23
7	1.13	1.20	----	0.24
8	0.40	0.47	----	0.23
9	1.46	1.53	----	0.24
10	1.13	1.19	----	0.24
11	0.84	0.90	----	0.22
12	1.35	1.43	----	0.22

Plt
0.23



**BUREAU
VERITAS**

Test Report No.: CE2312WDG0186

SUN2000-115KTL-M2 AC 400V Full Load:

Regulation : IEC61000-3-11 Ed1.0
 IEC61000-4-15 Ed1.1
 Interval : 10Min0Sec
 Model : YOKOGAWA WT3000
 Impedance : 0.24+j0.15
 Wiring : three-phase 4wire
 Voltage Range : 600.00V
 Set Voltage : ---
 Set Frequency : 50Hz
 Voltage U1 : 230.71V
 Frequency U1 : 49.999Hz
 Element : 1
 dmin : 0.20%

PASS

Compatibility Condition : Compliance with IEC61000-3-3(Ztest)
 Element1 : Pass
 dc (3.30%) : Pass
 dmax(6.00%) : Pass
 d(t) (500ms) : ----
 Pst (1.00) : Pass
 Plt (0.65) : Pass

No.	dc[%]	dmax[%]	d(t)[ms]	Pst
1	1.19	1.57	----	0.24
2	1.26	1.58	----	0.23
3	2.20	2.48	----	0.24
4	1.72	1.90	----	0.23
5	1.38	1.65	----	0.23
6	1.97	2.50	----	0.14
7	1.00	1.31	----	0.11
8	1.27	1.39	----	0.14
9	1.12	1.36	----	0.22
10	1.49	1.85	----	0.25
11	0.62	0.73	----	0.24
12	0.68	1.30	----	0.24

Plt
0.22

Regulation : IEC61000-3-11 Ed1.0
 IEC61000-4-15 Ed1.1
 Interval : 10Min0Sec
 Model : YOKOGAWA WT3000
 Impedance : 0.24+j0.15
 Wiring : three-phase 4wire
 Voltage Range : 600.00V
 Set Voltage : ---
 Set Frequency : 50Hz
 Voltage U2 : 232.50V
 Frequency U2 : 50.002Hz
 Element : 2
 dmin : 0.20%

PASS

Compatibility Condition : Compliance with IEC61000-3-3(Ztest)
 Element2 : Pass
 dc (3.30%) : Pass
 dmax(6.00%) : Pass
 d(t) (500ms) : ----
 Pst (1.00) : Pass
 Plt (0.65) : Pass

No.	dc[%]	dmax[%]	d(t)[ms]	Pst
1	1.63	1.71	----	0.24
2	1.59	1.76	----	0.25
3	1.80	1.84	----	0.24
4	1.66	1.81	----	0.25
5	1.39	1.52	----	0.23
6	1.53	1.56	----	0.16
7	1.70	1.75	----	0.13
8	1.54	1.67	----	0.15
9	1.25	1.41	----	0.24
10	1.16	1.36	----	0.25
11	0.64	1.01	----	0.25
12	1.20	1.39	----	0.25

Plt
0.23

**Bureau Veritas Shenzhen Co., Ltd.
Dongguan Branch**

No. 96, Guantai Road (Houjie Section), Houjie
 Town, Dongguan City, Guangdong Province.
 523942. People's Republic of China

Tel: +86 769 8998 2098
 Fax: +86 769 8593 1080
 Email: customerservice.dg@bureauveritas.com



Test Report No.: CE2312WDG0186

Regulation : IEC61000-3-11 Ed1.0
 IEC61000-4-15 Ed1.1
 Interval : 10Min0Sec
 Model : YOKOGAWA WT3000
 Impedance : 0.24+j0.15
 Wiring : three-phase 4wire
 Voltage Range : 600.00V
 Set Voltage : ---
 Set Frequency : 50Hz
 Voltage U3 : 229.20V
 Frequency U3 : Error
 Element : 3
 dmin : 0.20%

PASS

Compatibility Condition : Compliance with IEC61000-3-3(Ztest)
 Element3 : Pass
 dc (3.30%) : Pass
 dmax(6.00%) : Pass
 d(t) (500ms) : ----
 Pst (1.00) : Pass
 Plt (0.65) : Pass

No.	dc[%]	dmax[%]	d(t)[ms]	Pst
1	1.17	1.34	----	0.25
2	1.38	1.42	----	0.24
3	1.73	1.86	----	0.24
4	1.47	1.62	----	0.25
5	1.24	1.32	----	0.23
6	1.63	1.70	----	0.16
7	0.92	1.06	----	0.13
8	1.19	1.31	----	0.15
9	1.03	1.15	----	0.24
10	1.27	1.36	----	0.25
11	0.98	1.09	----	0.26
12	0.97	1.01	----	0.24

Plt
 0.23



4.1.2 PERFORMANCE CRITERIA

According to Clause 4 of EN IEC 61000-6-2:2019 standard, the following describes the general performance criteria.

CRITERION A	The apparatus shall continue to operate as intended during and after the test. No degradation of performance or loss of function is allowed below a performance level specified by the manufacturer, when the apparatus is used as intended. The performance level may be replaced by a permissible loss of performance. If the minimum performance level or the permissible performance loss is not specified by the manufacturer, either of these may be derived from the product description and documentation and what the user may reasonably expect from the apparatus if used as intended.
CRITERION B	The apparatus shall continue to operate as intended after the test. No degradation of performance or loss of function is allowed below a performance level specified by the manufacturer, when the apparatus is used as intended. The performance level may be replaced by a permissible loss of performance. During the test, degradation of performance is however allowed. No change of operating state or stored data is allowed. If the minimum performance level or the permissible performance loss is not specified by the manufacturer, either of these may be derived from the product description and documentation and what the user may reasonably expect from the apparatus if used as intended.
CRITERION C	Temporary loss of function is allowed, provided the function is self-recoverable or can be restored by the operation of the controls.



According to Clause 7.2 of EN 62920 standard, A precise description and definition of performance criterion shall be provided by the manufacturer and noted in the test report based on the following criteria.

Item	Criterion A	Criterion B	Criterion C
Operating status	No noticeable change of the operating status. Operating as intended.	Noticeable changes of the operating characteristic. Self-recoverable	Shutdown, changes in operating status. Triggering of protective devices. Not self-recoverable
Power output	Power output permitted to vary only within $\pm 25\%$.	Power output permitted to temporarily vary outside $\pm 25\%$ Self-recoverable	Loss of power output. Not self-recoverable
External and internal indications and metering	No noticeable change of the operating status.	Changes only during test	Shutdown, triggering of protective devices. Not self-recoverable
Control signal to external devices	Undisturbed communication and data exchange to external devices	Temporarily disturbed communication, but no error reports of the internal or external devices which could cause shut-down	Errors in communication, loss of data and information. No loss of stored program, no loss of user program. Not self-recoverable

4.1.3 EUT OPERATING CONDITION

Same as item 3.1.6



4.2 ELECTROSTATIC DISCHARGE IMMUNITY TEST (ESD) (EN IEC 61000-6-2 & EN 62920)

4.2.1 TEST SPECIFICATION

Basic Standard:	IEC 61000-4-2
Discharge Impedance:	330 ohm / 150 pF
Discharge Voltage:	Air Discharge: 4kV, 8 kV (Direct) Contact Discharge: 4 kV, 6kV (Indirect)
Polarity:	Positive & Negative
Number of Discharge:	20 times at each test point
Discharge Mode:	Single Discharge
Discharge Period:	1 second

4.2.2 TEST INSTRUMENTS

Equipment	Manufacturer	Model No.	Serial No.	Last Cal.	Next Cal.
ESD simulator	Teseq	NSG 437	398	2019/2/13	2020/2/12
ESD simulator	Teseq	NSG 437	398	2020/07/15	2021/07/14
ESD simulator	Teseq	NSG 437	398	2020/07/15	2021/12/13

- NOTE:** 1.The test was performed by witness in BF-61 room of Reliability Laboratory of Huawei Technologies Co., Ltd.
2.The test was performed in BF-61 Room.



4.2.3 TEST PROCEDURE

The basic test procedure was in accordance with IEC 61000-4-2:

- a. Electrostatic discharges were applied only to those points and surfaces of the EUT that are accessible to users during normal operation.
- b. The test was performed with at least ten single discharges on the pre-selected points in the most sensitive polarity.
- c. The time interval between two successive single discharges was at least 1 second.
- d. The discharge return cable of the generator shall be kept at a distance of at least 0.2 m from the EUT whilst the discharge is being applied and should not be held by the operator.
- e. Contact discharges were applied to the non-insulating coating, with the pointed tip of the generator penetrating the coating and contacting the conducting substrate.
- f. Air discharges were applied with the round discharge tip of the discharge electrode approaching the EUT as fast as possible (without causing mechanical damage) to touch the EUT. After each discharge, the ESD generator was removed from the EUT and re-triggered for a new single discharge. The test was repeated until all discharges were complete.
- g. At least ten single discharges (in the most sensitive polarity) were applied to the **Horizontal Coupling Plane** at points on each side of the EUT. The ESD generator was positioned horizontal at a distance of 0.1 meters from the EUT with the discharge electrode touching the **HCP**.
- h. At least ten single discharges (in the most sensitive polarity) were applied to the center of one vertical edge of the **Vertical Coupling Plane** in sufficiently different positions that the four faces of the EUT were completely illuminated. The **VCP** (dimensions 0.5m x 0.5m) was placed vertically to and 0.1 meters from the EUT.

4.2.4 DEVIATION FROM TEST STANDARD

No Deviation



4.2.5 TEST SETUP

(Setup and wiring)
IEC 61000-4-2
Electrical discharge immunity test
(Direct application: Contact discharge / Air discharge)

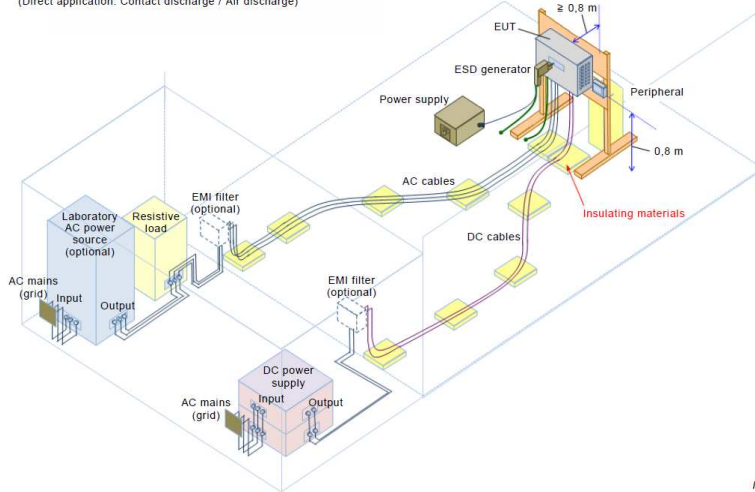

IEC

Figure A.1 – Example of a test setup for direct application of discharges to PCE

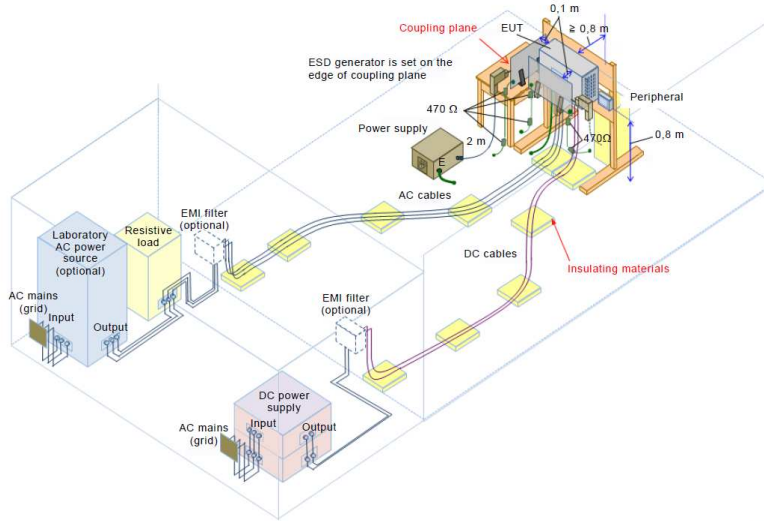

IEC

Figure A.2 – Example of a test setup for indirect application of discharges to PCE

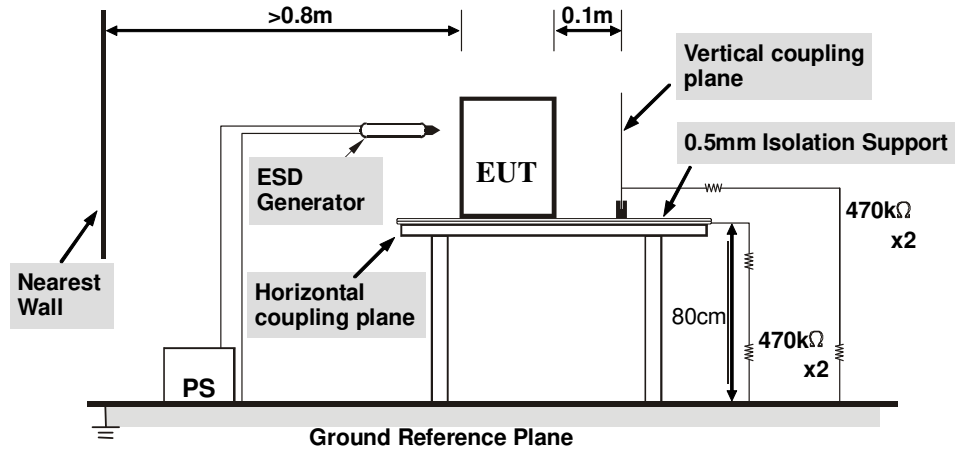

NOTE:

TABLE-TOP EQUIPMENT

The configuration consisted of a wooden table 0.8 meters high standing on the **Ground Reference Plane**. The **GRP** consisted of a sheet of aluminum at least 0.25mm thick, and 2.5 meters square connected to the protective grounding system. A **Horizontal Coupling Plane** (1.6m x 0.8m) was placed on the table and attached to the **GRP** by means of a cable with 940kΩ total impedance. The equipment under test, was installed in a representative system as described in section 7 of IEC 61000-4-2, and its cables were placed on the **HCP** and isolated by an insulating support of 0.5mm thickness. A distance of 0.8-meter minimum was provided between the EUT and the walls of the laboratory and any other metallic structure.

FLOOR-STANDING EQUIPMENT

The equipment under test was installed in a representative system as described in section 7 of IEC 61000-4-2, and its cables were isolated from the Ground Reference Plane by an insulating support of 0.1-meter thickness. The GRP consisted of a sheet of aluminum that is at least 0.25mm thick, and 2.5 meters square connected to the protective grounding system and extended at least 0.5 meters from the EUT on all sides.



4.2.6 TEST RESULTS

SUN2000-100KTL-M1 & SUN2000-115KTL-M2

TEST MODE	Mode A & Mode C	TEST VOLTAGE	DC 600V AC 400V & DC 600V AC 480V
ENVIRONMENTAL CONDITIONS	21deg. C, 50% RH 101.00kPa	TESTED BY: Wang Jia; Xuhaifeng	

Direct Discharge Application				
Test Level (kV)	Polarity	Test Point	Test Result of Contact Discharge	Test Result of Air Discharge
4, 6	+/-	All Metal Part	A	N/A
4, 8	+/-	All Non-metal Part	N/A	A

Indirect Discharge Application				
Discharge Level (kV)	Polarity	Test Point	Test Result of HCP	Test Result of VCP
4, 6	+/-	VCP	A	A

TEST MODE	Mode B & Mode D	TEST VOLTAGE	DC 0V AC 400V & DC 0V AC 480V
ENVIRONMENTAL CONDITIONS	21deg. C, 50% RH 101.00kPa	TESTED BY: Wang Jia, Xuhaifeng	

Direct Discharge Application				
Test Level (kV)	Polarity	Test Point	Test Result of Contact Discharge	Test Result of Air Discharge
4, 6	+/-	All Metal Part	A	N/A
4, 8	+/-	All Non-metal Part	N/A	A

Indirect Discharge Application				
Discharge Level (kV)	Polarity	Test Point	Test Result of HCP	Test Result of VCP
4, 6	+/-	VCP	A	A

NOTE: A: There was no change compared with initial operation during the test.



BUREAU VERITAS

Test Report No.: CE2312WDG0186

ESD TEST POINT

○ - Direct Contact Discharge; ✦ - Air Discharge)

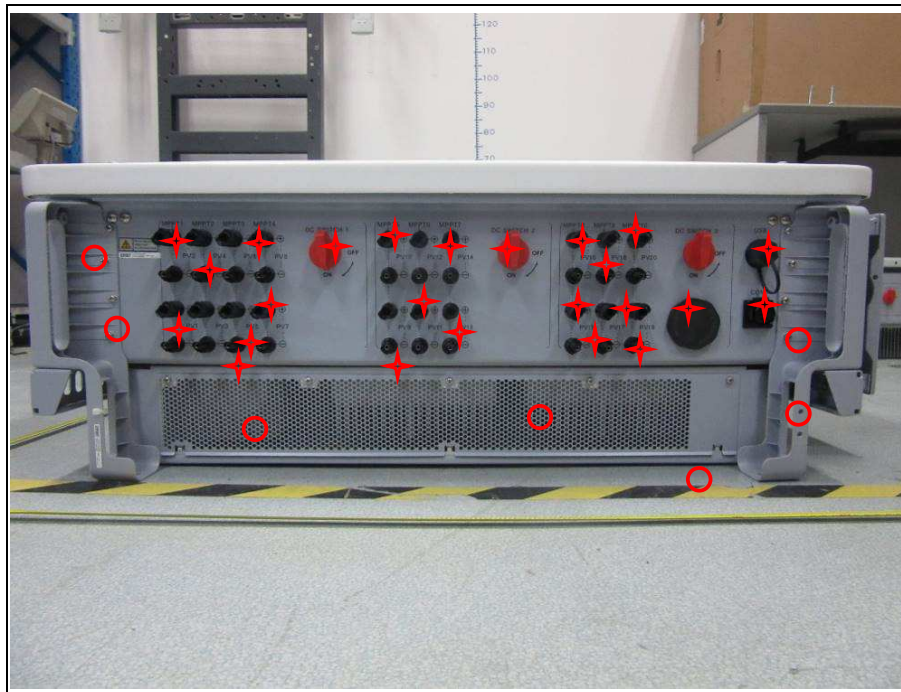
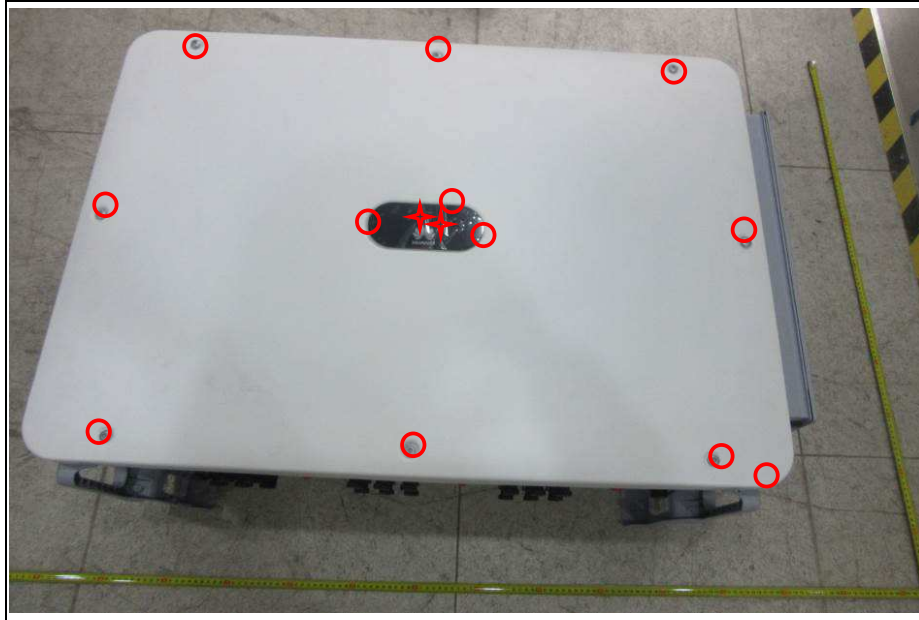

Bureau Veritas Shenzhen Co., Ltd.
Dongguan Branch

No. 96, Guantai Road (Houjie Section), Houjie
Town, Dongguan City, Guangdong Province.
523942. People's Republic of China

Tel: +86 769 8998 2098
Fax: +86 769 8593 1080
Email: customerservice.dg@bureauveritas.com



**BUREAU
VERITAS**

Test Report No.: CE2312WDG0186



**Bureau Veritas Shenzhen Co., Ltd.
Dongguan Branch**

No. 96, Guantai Road (Houjie Section), Houjie
Town, Dongguan City, Guangdong Province.
523942. People's Republic of China

Tel: +86 769 8998 2098
Fax: +86 769 8593 1080
Email: customerservice.dg@bureauveritas.com



4.3 RADIATED, RADIO-FREQUENCY, ELECTROMAGNETIC FIELD IMMUNITY TEST (RS) (EN IEC 61000-6-2 & EN 62920)

4.3.1 TEST SPECIFICATION

Basic Standard:	IEC 61000-4-3
Frequency Range:	80-1000MHz, 1400-6000MHz
Field Strength:	10V/m
Modulation:	1kHz Sine Wave, 80%, AM Modulation
Frequency Step:	1 % of fundamental
Polarity of Antenna:	Horizontal and Vertical
Antenna Height:	1.5m
Dwell Time:	at least 3 seconds

4.3.2 TEST INSTRUMENTS

Equipment	Manufacturer	Model No.	Serial No.	Last Cal.	Next Cal.
Signal generator	AR	SG6000	327339	2019/1/21	2020/1/20
Amplifier	AR	500W1000A	337312	2019/4/23	2020/4/22
Amplifier	AR	175S1G4M3	340318	2019/4/23	2020/4/22
Amplifier	rflight	NTWPAS-40 60100	16089043	2019/1/8	2020/1/7
Log-periodic antenna	SCHWARZBECK	STLP 9128D	9128D036	N/A	N/A
Log-periodic antenna	SCHWARZBECK	STLP 9149	9149-121	N/A	N/A
RF TEST SYS CTRLR	AR	SC1000	337402	N/A	N/A

Equipment	Manufacturer	Model No.	Serial No.	Last Cal.	Next Cal.
Signal generator	AR	SG6000	327339	2020/08/28	2021/08/27
Power Meter	AR	PM2003	339736	2020/04/26	2021/04/25
Amplifier	AR	500W1000A	337312	2020/04/26	2021/04/25
Amplifier	AR	175S1G4M3	340318	2020/04/26	2021/04/25
Amplifier	rflight	NTWPAS-40 60100	16089043	2020/08/28	2021/08/27
Directional Coupler	AR	DC6180A	0339521	2020/04/26	2021/04/25
Directional Coupler	AR	DC7144A	336840	2020/08/28	2021/08/27
Log-periodic antenna	AR	STLP 9128D	9128D036	N/A	N/A
Log-periodic antenna	AR	STLP 9149	9149-121	N/A	N/A

NOTE: 1.The test was performed by witness in 3m Chamber of ShangHai Huawei Technology Co., Ltd.
2.The test was performed in 3m Chamber.



4.3.3 TEST PROCEDURE

The test procedure was in accordance with IEC 61000-4-3

- a. The testing was performed in a fully-anechoic chamber.
- b. The frequency range is swept from 80 MHz to 1000 MHz, 1400MHz to 6000MHz, with the signal 80% amplitude modulated with a 1kHz sine wave.
- c. The dwell time at each frequency shall not be less than the time necessary for the EUT to be exercised and to respond, but shall in no case be less than 0,5s.
- d. The field strength levels were 10V/m.
- e. The test was performed with the EUT exposed to both vertically and horizontally polarized fields on each of the four sides.

4.3.4 DEVIATION FROM TEST STANDARD

No Deviation

4.3.5 TEST SETUP

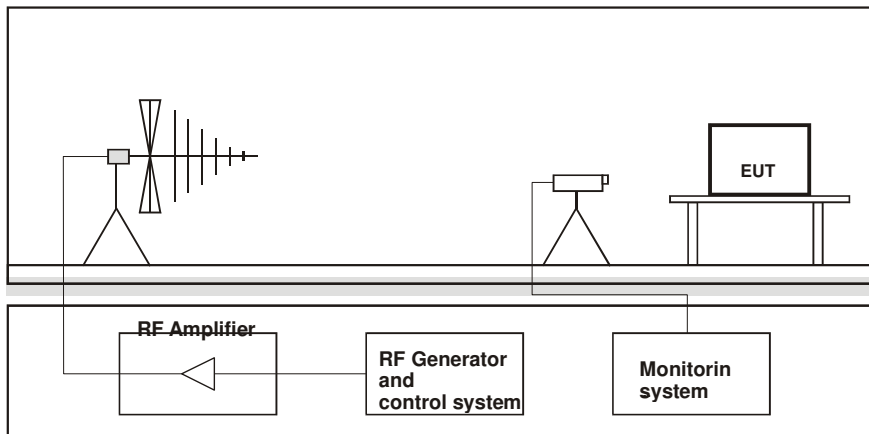

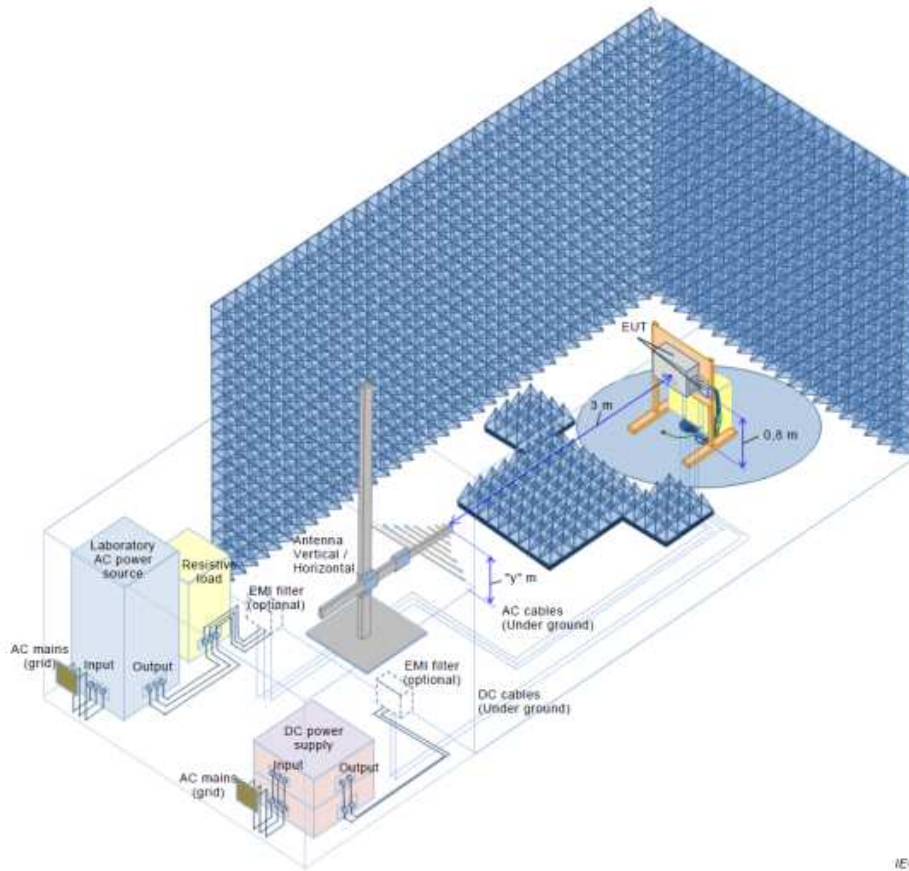

Figure A.3 – Example of a test setup for wall-mounted PCE

IEC

NOTE:

TABLETOP EQUIPMENT

The EUT installed in a representative system as described in section 7 of IEC 61000-4-3 was placed on a non-conductive table 0.8 meters in height. The system under test was connected to the power and signal wire according to relevant installation instructions.

FLOOR STANDING EQUIPMENT

The EUT installed in a representative system as described in section 7 of IEC 61000-4-3 was placed on a non-conductive wood support 0.1 meters in height. The system under test was connected to the power and signal wire according to relevant installation instructions.



4.3.6 TEST RESULTS

SUN2000-100KTL-M1

TEST MODE	Mode A & Mode C	TEST VOLTAGE	DC 600V AC 400V & DC 600V AC 480V
ENVIRONMENTAL CONDITIONS	21deg. C, 50% RH 101.00kPa	TESTED BY: Wang Jia	

Field Strength (V/m)	Test Frequency Note#1 (MHz)	Polarization of antenna (Horizontal / Vertical)	Test Distance (m)	Test Result	Remark
10	80 - 1000	H&V	3	A	N/A
10	1400 - 6000	H&V	3	A	N/A

TEST MODE	Mode B & Mode D	TEST VOLTAGE	DC 0V AC 400V & DC 0V AC 480V
ENVIRONMENTAL CONDITIONS	21deg. C, 50% RH 101.00kPa	TESTED BY: Wang Jia	

Field Strength (V/m)	Test Frequency Note#1 (MHz)	Polarization of antenna (Horizontal / Vertical)	Test Distance (m)	Test Result	Remark
10	80 - 1000	H&V	3	A	N/A
10	1400 - 6000	H&V	3	A	N/A

Note#1: Tested Israel SII Frequencies 89,100,107,144,163,196,244,315,434,460,600,825,845, 880 MHz

NOTE: A: There was no change compared with initial operation during the test.



4.4 ELECTRICAL FAST TRANSIENT/BURST IMMUNITY TEST (EFT) (EN IEC 61000-6-2 & EN 62920)

4.4.1 TEST SPECIFICATION

Basic Standard:	IEC 61000-4-4
Test Voltage:	Power Line: 2kV Signal Line: 1kV
Polarity:	Positive & Negative
Impulse Frequency:	5 kHz & 100 kHz
Impulse Waveshape :	5/50 ns
Burst Duration:	15 ms & 0.75 ms
Burst Period:	300 ms
Test Duration:	1 min.

4.4.2 TEST INSTRUMENTS

Equipment	Manufacturer	Model No.	Serial No.	Last Cal.	Next Cal.
Fast Transient Burt Simulator	SANKI	SKS-0404GB	0382-0150	2019/7/15	2020/7/14
Coupling Decoupling Network	Teseq	CDN163	0445-0848	2019/7/15	2020/7/14
Coupling clamp	Teseq	CDN8014	0382-0151	2019/7/1	2020/6/30

Equipment	Manufacturer	Model No.	Serial No.	Last Cal.	Next Cal.
Fast Transient Burt Simulator	3CTEST	EFT 500G	ES0241904	2020/08/27	2021/08/26
Coupling Decoupling Network	3CTEST	EFTN 1550T	ES4061901	2020/08/27	2021/08/26
Coupling Decoupling Network	Teseq	CDN163	160	2020/08/27	2021/08/26
Coupling clamp	Teseq	CDN8014	31839	2020/08/27	2021/08/26

NOTE: 1. The test was performed by witness in Shanghai Testing & Inspection Institute for Electrical Equipment.
2. The test was performed in Immunity Room.

Equipment	Manufacturer	Model No.	Serial No.	Last Cal.	Next Cal.
Fast Transient Burt Simulator	3CTEST	EFT 500G	ES0241904	2022/08/05	2023/08/04
Coupling Decoupling Network	3CTEST	EFTN 1550T	ES4061901	2022/08/05	2023/08/04
Coupling Decoupling Network	Teseq	CDN163	160	2022/08/05	2023/08/04

NOTE: 1. The test was performed by witness in Reliability Laboratory of Huawei Technologies Co., Ltd.
2. The test was performed in Immunity Room.



4.4.3 TEST PROCEDURE

- a. Both positive and negative polarity discharges were applied.
- b. The distance between any coupling devices and the EUT should be $(0.5 - 0/+0.1)$ m for table-top equipment testing, and (1.0 ± 0.1) m for floor standing equipment.
- c. The duration time of each test sequential was 1 minute.
- d. The transient/burst waveform was in accordance with IEC 61000-4-4, 5/50ns.

4.4.4 DEVIATION FROM TEST STANDARD

No deviation.

4.4.5 TEST SETUP

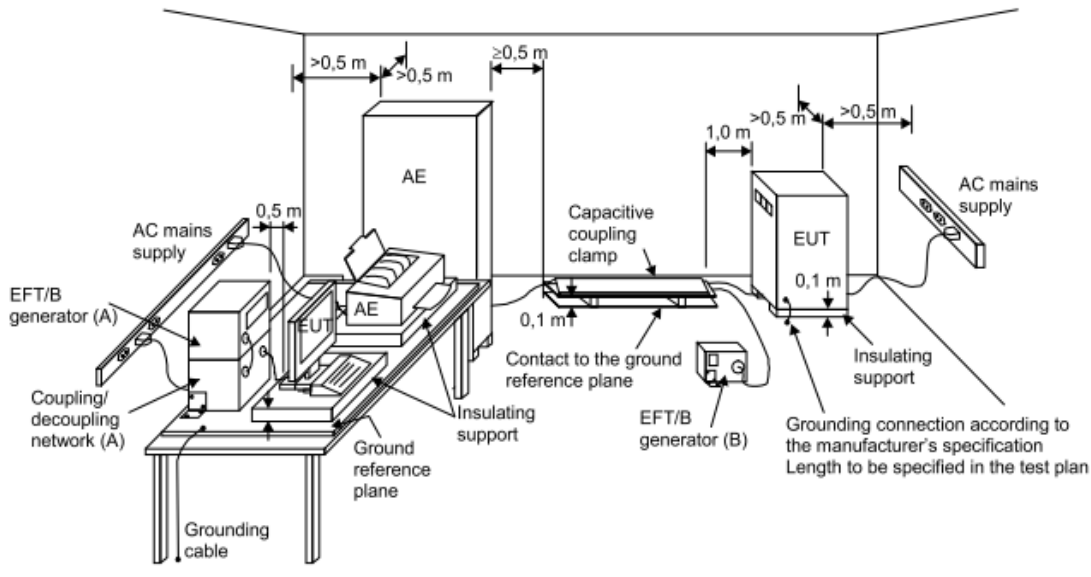

IEC 645/12

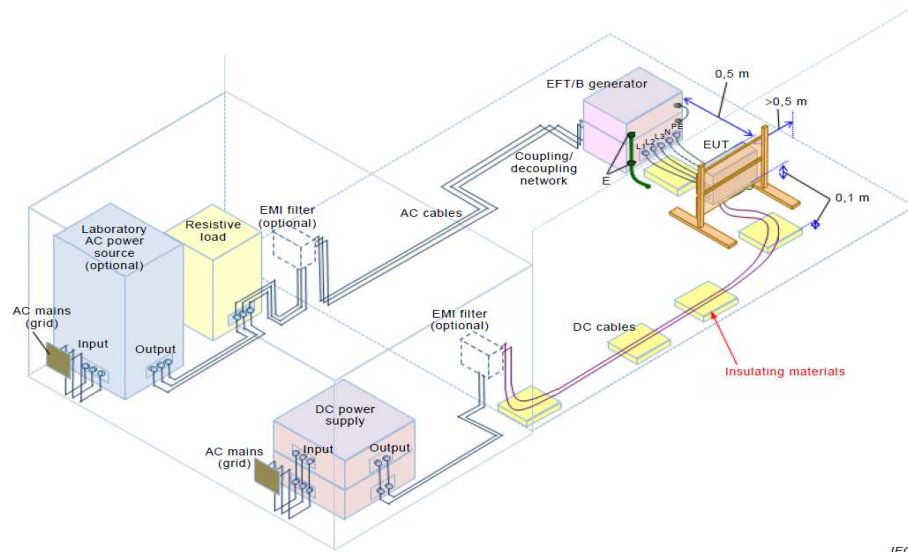

IEC

Figure A.4 – Example of a test setup for direct coupling of the test voltage to AC mains power ports

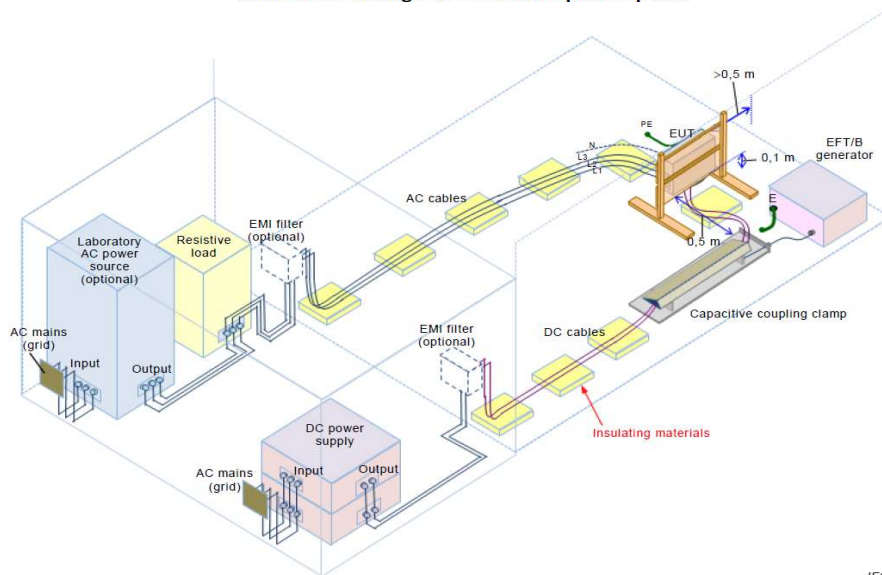

IEC

Figure A.5 – Example of a test setup for application of the test voltage with a capacitive coupling clamp

NOTE:

- (A) location for supply line coupling
- (B) location for signal lines coupling

For the actual test configuration, please refer to the related item – Photographs of the Test Configuration.



4.4.6 TEST RESULTS

SUN2000-100KTL-M1

TEST MODE	Mode A & Mode C	TEST VOLTAGE	DC 600V AC 400V & DC 600V AC 480V
ENVIRONMENTAL CONDITIONS	21 deg. C, 55% RH	TESTED BY: Wang Jia	

Pulse Voltage	1 kV		2 kV		kV		kV	
	+	-	+	-	+	-	+	-
L1+L2+L3 + PE	/	/	A	A	/	/	/	/
L1+L2+L3	/	/	A	A	/	/	/	/
N								
PE	/	/	A	A	/	/	/	/
L1+L2+L3 + N + PE	/	/	A	A	/	/	/	/
PV+&PV-, PE	/	/	A	A	/	/	/	/
RS 485 Port	A	A	/	/	/	/	/	/
MBUS Port (L1+L2+L3 + N +PE)	/	/	A	A	/	/	/	/
MBUS Port N	/	/	A	A	/	/	/	/
MBUS Port L1+L2+L3	/	/	A	A	/	/	/	/
MBUS Port PE	/	/	A	A	/	/	/	/



TEST MODE	Mode B & Mode D	TEST VOLTAGE	DC 0V AC 400V & DC 0V AC 480V
ENVIRONMENTAL CONDITIONS	21 deg. C, 55% RH	TESTED BY: Wang Jia	

Pulse Voltage	1 kV		2 kV		kV		kV	
	+	-	+	-	+	-	+	-
Pulse Polarity								
L1+L2+L3 + PE	/	/	A	A	/	/	/	/
L1+L2+L3	/	/	A	A	/	/	/	/
N								
PE	/	/	A	A	/	/	/	/
L1+L2+L3 + N + PE	/	/	A	A	/	/	/	/
PV+&PV-, PE	/	/	A	A	/	/	/	/
RS 485 Port	A	A	/	/	/	/	/	/
MBUS Port (L1+L2+L3 + N +PE)	/	/	A	A	/	/	/	/
MBUS Port N	/	/	A	A	/	/	/	/
MBUS Port L1+L2+L3	/	/	A	A	/	/	/	/
MBUS Port PE	/	/	A	A	/	/	/	/

NOTE: A: There was no change compared with initial operation during the test.



**BUREAU
VERITAS**

Test Report No.: CE2312WDG0186

SUN2000-115KTL-M2:

TEST MODE	Mode A & Mode C	TEST VOLTAGE	DC 600V AC 400V & DC 600V AC 480V
ENVIRONMENTAL CONDITIONS	21 deg. C, 55% RH	TESTED BY: Xuhaifeng	

Pulse Voltage	1 kV		2 kV		kV		kV	
	+	-	+	-	+	-	+	-
Pulse Polarity	+	-	+	-	+	-	+	-
L1+L2+L3 + PE	/	/	A	A	/	/	/	/
L1+L2+L3	/	/	A	A	/	/	/	/
N								
PE	/	/	A	A	/	/	/	/
L1+L2+L3 + N + PE	/	/	A	A	/	/	/	/
PV+&PV-, PE	/	/	A	A	/	/	/	/
MBUS Port (L1+L2+L3 + N +PE)	/	/	A	A	/	/	/	/
MBUS Port N	/	/	A	A	/	/	/	/
MBUS Port L1+L2+L3	/	/	A	A	/	/	/	/
MBUS Port PE	/	/	A	A	/	/	/	/

**Bureau Veritas Shenzhen Co., Ltd.
Dongguan Branch**

No. 96, Guantai Road (Houjie Section), Houjie
Town, Dongguan City, Guangdong Province.
523942. People's Republic of China

Tel: +86 769 8998 2098
Fax: +86 769 8593 1080
Email: customerservice.dg@bureauveritas.com



TEST MODE	Mode B & Mode D	TEST VOLTAGE	DC 0V AC 400V & DC 0V AC 480V
ENVIRONMENTAL CONDITIONS	21 deg. C, 55% RH	TESTED BY: Xuhaifeng	

Pulse Voltage	1 kV		2 kV		kV		kV	
	+	-	+	-	+	-	+	-
Pulse Polarity								
L1+L2+L3 + PE	/	/	A	A	/	/	/	/
L1+L2+L3	/	/	A	A	/	/	/	/
N								
PE	/	/	A	A	/	/	/	/
L1+L2+L3 + N + PE	/	/	A	A	/	/	/	/
PV+&PV-, PE	/	/	A	A	/	/	/	/
MBUS Port (L1+L2+L3 + N +PE)	/	/	A	A	/	/	/	/
MBUS Port N	/	/	A	A	/	/	/	/
MBUS Port L1+L2+L3	/	/	A	A	/	/	/	/
MBUS Port PE	/	/	A	A	/	/	/	/

NOTE: A: There was no change compared with initial operation during the test.



4.5 SURGE IMMUNITY TEST (EN IEC 61000-6-2 & EN 62920)

4.5.1 TEST SPECIFICATION

Basic Standard:	IEC 61000-4-5
Wave-Shape:	Combination Wave 1.2/50 us Open Circuit Voltage 8 /20 us Short Circuit Current
Test Voltage:	AC Power Line: Line to Line:1kV Line to PE:2kV DC Power Line: Line to Line:1kV (Client requirement) Line to PE:2kV (Client requirement) Signal Line:1kV, 2kV (Client requirement)
Surge Input/Output:	L1-L2-L3&L-PE,N-PE, L1-L2-L3-N, RS 485, DC Port
Polarity:	Positive/Negative
Phase Angle:	0° /90°/180°/270°
Pulse Repetition Rate:	1 time / 60 sec.
Number of Tests:	5 positive and 5 negative at selected points

4.5.2 TEST INSTRUMENTS

Equipment	Manufacturer	Model No.	Serial No.	Last Cal.	Next Cal.
High Energy Pulse Generator	3cTEST	CWS 1000G	ES3521701	2019/1/21	2020/1/20
Coupling Decoupling Network	3cTEST	SPN1550T	ES4221701	2019/1/24	2020/1/23
Coupling Decoupling Network	3cTEST	SPN1550T	ES4221702	2019/1/24	2020/1/23

Equipment	Manufacturer	Model No.	Serial No.	Last Cal.	Next Cal.
High Energy Pulse Generator	3cTEST	CWS 1000G	ES3521701	2020/08/27	2021/08/26
Coupling Decoupling Network	3cTEST	SPN1550T	ES4221701	2020/08/27	2021/08/26
Coupling Decoupling Network	3cTEST	SPN1550T	ES4221702	2020/08/27	2021/08/26

NOTE: 1. The test was performed by witness in BF-65 room of ShangHai Huawei Technology Co., Ltd.
2. The test was performed in BF-65 Room.



Equipment	Manufacturer	Model No.	Serial No.	Last Cal.	Next Cal.
High Energy Pulse Generator	3cTEST	CWS 1000G	ES3521701	2022/08/05	2023/08/04
Coupling Decoupling Network	3cTEST	SPN1550T	ES4221701	2022/08/06	2023/08/05
Coupling Decoupling Network	3cTEST	SPN1550T	ES4221702	2022/08/06	2023/08/05

Equipment	Manufacturer	Model No.	Serial No.	Last Cal.	Next Cal.
High Energy Pulse Generator	3cTEST	CWS 1000G	ES3521701	2022/08/07	2023/08/06
Coupling Decoupling Network	3cTEST	SPN1550T	ES4221701	2023/06/27	2024/06/26
Coupling Decoupling Network	3cTEST	SPN1550T	ES4221702	2023/06/27	2024/06/26

NOTE: 1. The test was performed by witness in BF-65 room of Reliability Laboratory of Huawei Technologies Co., Ltd.
 2. The test was performed in BF-65 Room.

4.5.3 TEST PROCEDURE

a. For EUT power supply:

The surge is to be applied to the EUT power supply terminals via the capacitive coupling network. Decoupling networks are required in order to avoid possible adverse effects on equipment not under test that may be powered by the same lines, and to provide sufficient decoupling impedance to the surge wave. The power cord between the EUT and the coupling/decoupling networks shall be 2 meters in length (or shorter).

b. For test applied to unshielded unsymmetrically operated interconnection lines of EUT:

The surge is applied to the lines via the capacitive coupling. The coupling / decoupling networks shall not influence the specified functional conditions of the EUT. The interconnection line between the EUT and the coupling/decoupling networks shall be 2 meters in length (or shorter).

c. For test applied to unshielded symmetrically operated interconnection / telecommunication lines of EUT:

The surge is applied to the lines via gas arrestors coupling. Test levels below the ignition point of the coupling arrestor cannot be specified. The interconnection line between the EUT and the coupling/decoupling networks shall be 2 meters in length (or shorter).

4.5.4 DEVIATION FROM TEST STANDARD

No deviation.



4.5.5 TEST SETUP

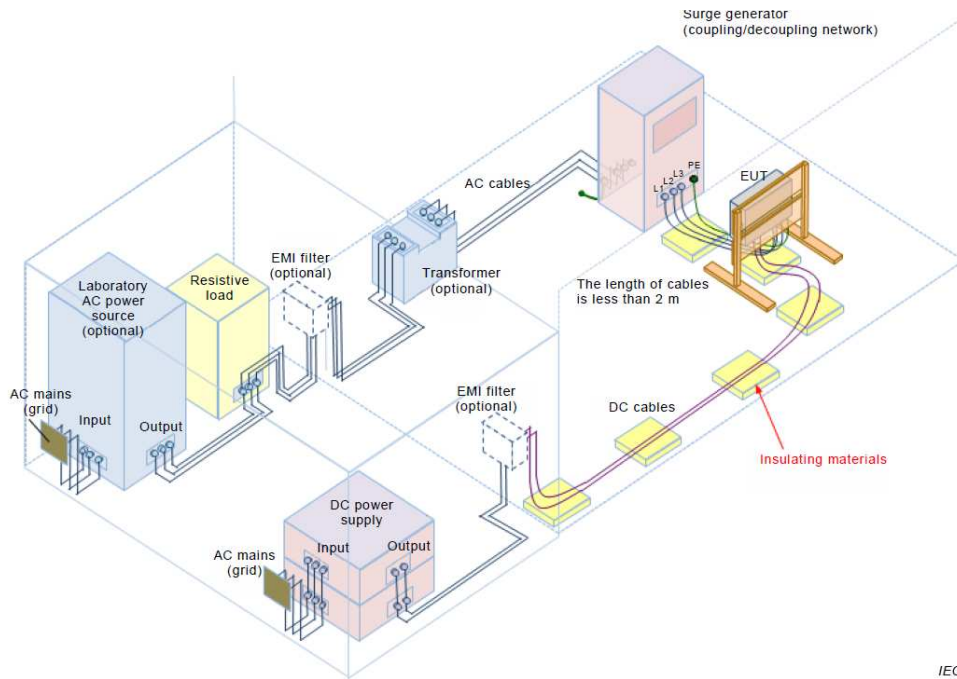
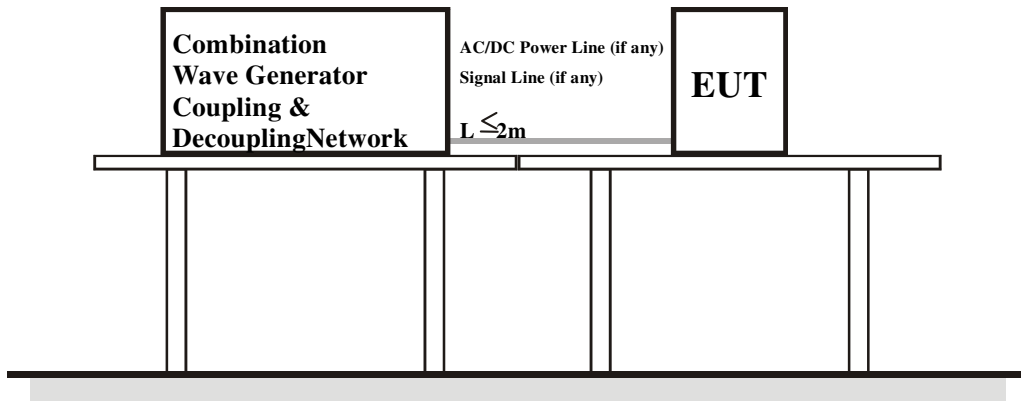
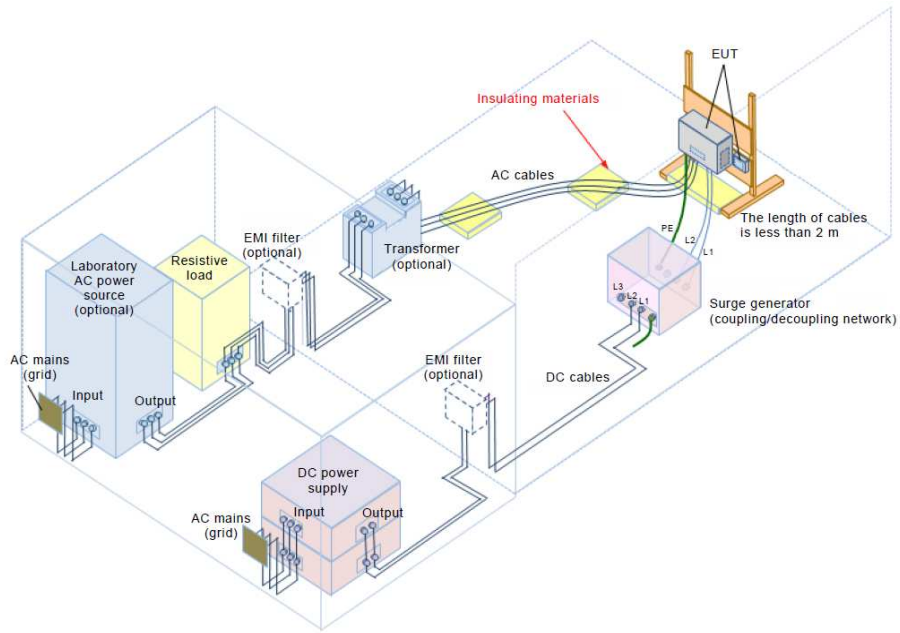

Figure A.6 – Example of a test setup for AC mains power ports

IEC



IEC

Figure A.7 – Example of a test setup for DC power ports



4.5.6 TEST RESULTS

SUN2000-100KTL-M1

TEST MODE	Mode A & Mode C	TEST VOLTAGE	DC 600V AC 400V & DC 600V AC 480V
ENVIRONMENTAL CONDITIONS	21deg. C, 55% RH	TESTED BY: Wang Jia	

AC/DC Power port:

Voltage (kV)	\Phase angle \ Test point	\ Test result \ Polarity	0°	90°	180°	270°	Test point	DC Power Port
1	L1-L2	+	A	A	A	A	PV+ - PV-	A
		-	A	A	A	A		A
1	L1-L3	+	A	A	A	A	/	/
		-	A	A	A	A	/	/
1	L2-L3	+	A	A	A	A	/	/
		-	A	A	A	A	/	/
1	L1-L2-L3-N	+	A	A	A	A	/	/
		-	A	A	A	A	/	/
2	N-PE	+	A	A	A	A	PV+ - PE	A
		-	A	A	A	A		A
2	L1-PE	+	A	A	A	A	PV- - PE	A
		-	A	A	A	A		A
2	L2-PE	+	A	A	A	A	/	/
		-	A	A	A	A	/	/
2	L3-PE	+	A	A	A	A	/	/
		-	A	A	A	A	/	/

Signal ports and telecommunication ports:

Voltage (kV)	Test Point	Polarity	Test result	Voltage (kV)	Test Point	Polarity	Test result
2	RS 485 Port	+/-	A	/	/	+/-	/

NOTE: A: There was no change compared with initial operation during the test.



TEST MODE	Mode B & Mode D	TEST VOLTAGE	DC 0V AC 400V & DC 0V AC 480V
ENVIRONMENTAL CONDITIONS	21deg. C, 55% RH	TESTED BY: Wang Jia	

AC/DC Power port:

Voltage (kV)	\Phase angle \ Test point\ Test point\ Polarity	Polarity	0°	90°	180°	270°	Test point	DC Power Port
1	L1-L2	+	A	A	A	A	PV+ - PV-	A
		-	A	A	A	A		A
1	L1-L3	+	A	A	A	A	/	/
		-	A	A	A	A	/	/
1	L2-L3	+	A	A	A	A	/	/
		-	A	A	A	A	/	/
1	L1-L2-L3-N	+	A	A	A	A	/	/
		-	A	A	A	A	/	/
2	N-PE	+	A	A	A	A	PV+ - PE	A
		-	A	A	A	A		A
2	L1-PE	+	A	A	A	A	PV- - PE	A
		-	A	A	A	A		A
2	L2-PE	+	A	A	A	A	/	/
		-	A	A	A	A	/	/
2	L3-PE	+	A	A	A	A	/	/
		-	A	A	A	A	/	/

Signal ports and telecommunication ports:

Voltage (kV)	Test Point	Polarity	Test result	Voltage (kV)	Test Point	Polarity	Test result
2	RS 485 Port	+/-	A	/	/	+/-	/

NOTE: A: There was no change compared with initial operation during the test.



**BUREAU
VERITAS**

Test Report No.: CE2312WDG0186

SUN2000-115KTL-M2

TEST MODE	Mode A & Mode C	TEST VOLTAGE	DC 600V AC 400V & DC 600V AC 480V
ENVIRONMENTAL CONDITIONS	21deg. C, 55% RH	TESTED BY: Wang Jia	

AC/DC Power port:

Phase angle \ Test result Voltage (kV) \ Test point \ Polarity	0°	90°	180°	270°	Test point	DC Power Port
1 L1-L2	+	A	A	A	PV+ - PV-	A
	-	A	A	A		A
1 L1-L3	+	A	A	A	/	/
	-	A	A	A	/	/
1 L2-L3	+	A	A	A	/	/
	-	A	A	A	/	/
1 L1-L2-L3-N	+	A	A	A	/	/
	-	A	A	A	/	/
2 N-PE	+	A	A	A	PV+ - PE	A
	-	A	A	A		A
2 L1-PE	+	A	A	A	PV- - PE	A
	-	A	A	A		A
2 L2-PE	+	A	A	A	/	/
	-	A	A	A	/	/
2 L3-PE	+	A	A	A	/	/
	-	A	A	A	/	/
6 L1-L2	+	B	B	B	/	/
	-	B	B	B	/	/
6 L1-L3	+	B	B	B	/	/
	-	B	B	B	/	/
6 L2-L3	+	B	B	B	/	/
	-	B	B	B	/	/
6 L1-L2-L3-N	+	B	B	B	/	/
	-	B	B	B	/	/
6 N-PE	+	B	B	B	/	/
	-	B	B	B	/	/
6 L1-PE	+	B	B	B	/	/
	-	B	B	B	/	/
6 L2-PE	+	B	B	B	/	/
	-	B	B	B	/	/
6 L3-PE	+	B	B	B	/	/
	-	B	B	B	/	/
4 N/A	+	/	/	/	PV+ - PE	B
	-	/	/	/		B

**Bureau Veritas Shenzhen Co., Ltd.
Dongguan Branch**

No. 96, Guantai Road (Houjie Section), Houjie
Town, Dongguan City, Guangdong Province.
523942. People's Republic of China

Tel: +86 769 8998 2098
Fax: +86 769 8593 1080
Email: customerservice.dg@bureauveritas.com



4	N/A	+	/	/	/	/	PV- - PE	B
		-	/	/	/	/		B
4	N/A	+	/	/	/	/	PV+ - PV-	B
		-	/	/	/	/		B

NOTE: A: There was no change compared with initial operation during the test.

B: Occasionally reset during the test, and the normal grid connection can be restored automatically after the test.



**BUREAU
VERITAS**

Test Report No.: CE2312WDG0186

TEST MODE	Mode A & Mode C	TEST VOLTAGE	DC 600V AC 400V & DC 600V AC 480V
ENVIRONMENTAL CONDITIONS	21deg. C, 55% RH	TESTED BY: Wang Jia	

AC/DC Power port:

Voltage (kV)	\Phase angle \ Test result \ Test point\ Polarity	0°	90°	180°	270°	Test point	DC Power Port
1	L1-L2	+	A	A	A	PV+ - PV-	A
		-	A	A	A		A
1	L1-L3	+	A	A	A	/	/
		-	A	A	A	/	/
1	L2-L3	+	A	A	A	/	/
		-	A	A	A	/	/
1	L1-L2-L3-N	+	A	A	A	/	/
		-	A	A	A	/	/
2	N-PE	+	A	A	A	PV+ - PE	A
		-	A	A	A		A
2	L1-PE	+	A	A	A	PV- - PE	A
		-	A	A	A		A
2	L2-PE	+	A	A	A	/	/
		-	A	A	A	/	/
2	L3-PE	+	A	A	A	/	/
		-	A	A	A	/	/
6	L1-L2	+	B	B	B	/	/
		-	B	B	B	/	/
6	L1-L3	+	B	B	B	/	/
		-	B	B	B	/	/
6	L2-L3	+	B	B	B	/	/
		-	B	B	B	/	/
6	L1-L2-L3-N	+	B	B	B	/	/
		-	B	B	B	/	/
6	N-PE	+	B	B	B	/	/
		-	B	B	B	/	/
6	L1-PE	+	B	B	B	/	/
		-	B	B	B	/	/
6	L2-PE	+	B	B	B	/	/
		-	B	B	B	/	/
6	L3-PE	+	B	B	B	/	/
		-	B	B	B	/	/
4	N/A	+	/	/	/	PV+ - PE	B
		-	/	/	/		B

**Bureau Veritas Shenzhen Co., Ltd.
Dongguan Branch**

No. 96, Guantai Road (Houjie Section), Houjie
Town, Dongguan City, Guangdong Province.
523942. People's Republic of China

Tel: +86 769 8998 2098
Fax: +86 769 8593 1080
Email: customerservice.dg@bureauveritas.com



4	N/A	+	/	/	/	/	PV- - PE	B
		-	/	/	/	/		B
4	N/A	+	/	/	/	/	PV+ - PV-	B
		-	/	/	/	/		B

NOTE: A: There was no change compared with initial operation during the test.

B: Occasionally reset during the test, and the normal grid connection can be restored automatically after the test.



4.6 IMMUNITY TO CONDUCTED DISTURBANCES INDUCED BY RF FIELDS (CS) (EN IEC 61000-6-2 & EN 62920)

4.6.1 TEST SPECIFICATION

Basic Standard:	IEC 61000-4-6
Frequency Range:	0.15 MHz - 80 MHz
Field Strength:	10V _{r.m.s}
Modulation:	1kHz Sine Wave, 80%, AM Modulation
Frequency Step:	1 % of fundamental
Coupled Cable:	Power Mains & DC Power Line & Signal Line
Coupling Device:	Current Probe & Direct injection & Clamp injection & CDN-M1

4.6.2 TEST INSTRUMENTS

Equipment	Manufacturer	Model No.	Serial No.	Last Cal.	Next Cal.
Signal generator	R&S	SMC100A	1411.4002k02-102618-Yb	2019/1/21	2020/1/20
Amplifier	R&S	BBA100	5354.9000k50-100984-Ut	2019/1/18	2020/1/17
6dB Attenuator	Bird	75-A-FFN-06	1180092	2019/1/18	2020/1/17
Coupling Decoupling Network	Teseq	CDNST08A	51382	2019/1/22	2020/1/21
Coupling Decoupling Network	FCC	FCC-801-M1-50A	111651	2019/4/25	2020/4/24
RF Inject Clamp	FCC	F-120-9A	111657	2019/1/17	2020/1/16

Equipment	Manufacturer	Model No.	Serial No.	Last Cal.	Next Cal.
Signal generator	R&S	SMC100A	1411.4002k02-102618-Yb	2020/08/29	2021/08/28
Amplifier	R&S	BBA100	5354.9000k50-100984-Ut	2020/03/22	2021/03/21
6dB Attenuator	Bird	75-A-FFN-06	1180092	2020/08/29	2021/08/28
Power Meter	R&S	NRVD	102154	2020/04/28	2021/04/27
Coupling Decoupling Network	FCC	FCC-801-M1-50A	111651	2020/08/28	2021/08/27
RF Inject Clamp	FCC	F-120-9A	111657	2020/08/28	2021/08/27
100Ω Resistance	Luthi	CR100A	369	2020/04/28	2021/04/27

- NOTE:** 1. The test was performed by witness in CS Shielding room of ShangHai Huawei Technology Co., Ltd.
 2. The test was performed in CS Shielding Room.



Equipment	Manufacturer	Model No.	Serial No.	Last Cal.	Next Cal.
Signal generator	R&S	SMC100A	1411.4002k02-102618-Yb	2022/08/11	2023/08/10
Amplifier	R&S	BBA100	5354.9000k50-100984-Ut	2021/12/03	2022/12/02
6dB Attenuator	Bird	75-A-FFN-06	1180092	2022/08/04	2023/08/03
Power Meter	R&S	NRVD	102154	2021/12/03	2022/12/02
Coupling Decoupling Network	FCC	FCC-801-M1-50A	111651	2022/08/04	2023/08/03
RF Inject Clamp	FCC	F-120-9A	111657	2021/12/9	2022/12/08

NOTE: 1. The test was performed by witness in CS Shielding room of ShangHai Huawei Technology Co., Ltd.
2. The test was performed in CS Shielding Room

4.6.3 TEST PROCEDURE

- a. The EUT shall be tested within its intended operating and climatic conditions.
- b. An artificial hand was placed on the hand-held accessory and connected to the ground reference plane.
- c. The test shall be performed with the test generator connected to each of the coupling and decoupling devices in turn, while the other non-excited RF input ports of the coupling devices are terminated by a 50-ohm load resistor.
- d. The frequency range is swept from 150 kHz to 80 MHz, using the signal level established during the setting process and with a disturbance signal of 80 % amplitude. The signal is modulated with a 1 kHz sine wave, pausing to adjust the RF signal level or the switch coupling devices as necessary. Where the frequency is swept incrementally, the step size shall not exceed 1 % of the preceding frequency value.
- e. The dwell time of the amplitude modulated carrier at each frequency shall not be less than the time necessary for the EUT to be exercised and to respond, but shall in no case be less than 0,5 s. The sensitive frequencies (e.g. clock frequencies) shall be analyzed separately.
- f. Attempts should be made to fully exercise the EUT during testing, and to fully interrogate all exercise modes selected for susceptibility.
- g. It is recommended that all ports are connected to coupling/decoupling devices. Where the PCE has two or more DC power ports, all DC power ports are recommended to be connected to the coupling/decoupling devices.
- h. Wall-mounted PCE should be tested with an insulating support of (0.1±0.05)m in height above the ground reference plane. A wooden rack can be used to mount the PCE. All cables connected to the PCE should be isolated from the ground reference plane by wooden materials or insulating materials with a thickness of at least 30mm. The minimum distance between the PCE and any metallic objects, except the test equipment, should be 0.5m.



4.6.4 DEVIATION FROM TEST STANDARD

No deviation.

4.6.5 TEST SETUP

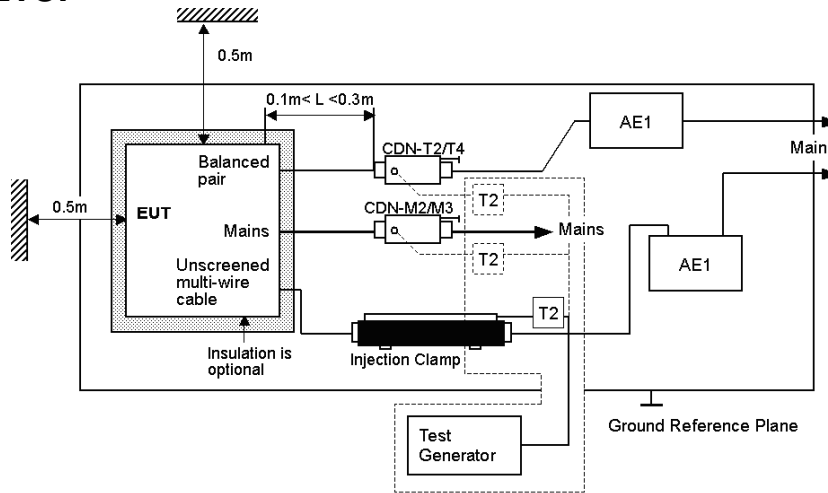

NOTE: The EUT clearance from any metallic obstacles shall be at least 0.5m.
 All non-excited input ports of the CDNs shall be terminated by 50Ω loads.

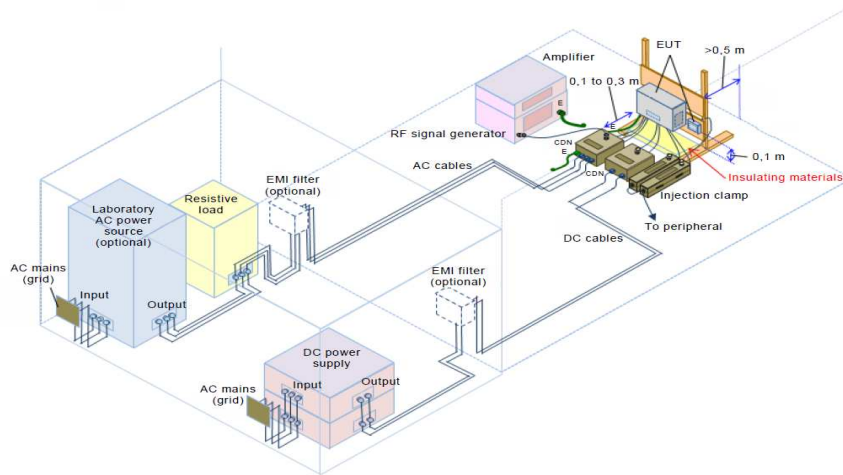

Figure A.8 – Example of a setup of conducted disturbances immunity test applied for wall-mounted PCE

NOTE:

FLOOR-STANDING EQUIPMENT

The equipment to be tested is placed on an insulating support of 0.1 meters height above a ground reference plane. All relevant cables shall be provided with the appropriate coupling and decoupling devices at a distance between 0.1 meters and 0.3 meters from the projected geometry of the EUT on the ground reference plane.



4.6.6 TEST RESULTS

SUN2000-100KTL-M1

TEST MODE	Mode A & Mode C	TEST VOLTAGE	DC 600V AC 400V & DC 600V AC 480V
ENVIRONMENTAL CONDITIONS	21deg. C, 54% RH	TESTED BY: Wang Jia	

Voltage (V)	Test Frequency Note#1 (MHz)	Tested Line	Injection Method.	Test Result	Remark
10	0.15 – 80	AC line	Current Probe	A	RS485
10	0.15 – 80	DC line	Current Probe	A	RS485
10	0.15 – 80	RS485 Cable	Direct injection	A	RS485
10	0.15 – 80	PE line	CDN-M1	A	RS485
10	0.15 – 80	AC	Current Probe	A	MBUS
10	0.15 – 80	DC line	Current Probe	A	MBUS
10	0.15 – 80	PE line	CDN-M1	A	MBUS

TEST MODE	Mode B & Mode D	TEST VOLTAGE	DC 0V AC 400V & DC 0V AC 480V
ENVIRONMENTAL CONDITIONS	21deg. C, 54% RH	TESTED BY: Wang Jia	

Voltage (V)	Test Frequency Note#1 (MHz)	Tested Line	Injection Method.	Test Result	Remark
10	0.15 – 80	AC line	Current Probe	A	RS485
10	0.15 – 80	DC line	Current Probe	A	RS485
10	0.15 – 80	RS485 Cable	Direct injection	A	RS485
10	0.15 – 80	PE line	CDN-M1	A	RS485
10	0.15 – 80	AC	Current Probe	A	MBUS
10	0.15 – 80	DC line	Current Probe	A	MBUS
10	0.15 – 80	PE line	CDN-M1	A	MBUS

Note#1: Tested Israel SII Frequencies 0.2,0.53,1,1.5,7.1,13.56,21,27.12,40.68,65,68 MHz

NOTE: A: There was no change compared with initial operation during the test.



SUN2000-115KTL-M2

TEST MODE	Mode A & Mode C	TEST VOLTAGE	DC 600V AC 400V & DC 600V AC 480V
ENVIRONMENTAL CONDITIONS	21deg. C, 54% RH	TESTED BY: Wang Jia	

Voltage (V)	Test Frequency Note#1 (MHz)	Tested Line	Injection Method.	Test Result	Remark
10	0.15 – 80	AC line	Current Probe	A	RS485
10	0.15 – 80	DC line	Current Probe	A	RS485
10	0.15 – 80	PE line	CDN-M1	A	RS485
10	0.15 – 80	AC	Current Probe	A	MBUS
10	0.15 – 80	DC line	Current Probe	A	MBUS
10	0.15 – 80	PE line	CDN-M1	A	MBUS

TEST MODE	Mode B & Mode D	TEST VOLTAGE	DC 0V AC 400V & DC 0V AC 480V
ENVIRONMENTAL CONDITIONS	21deg. C, 54% RH	TESTED BY: Wang Jia	

Voltage (V)	Test Frequency Note#1 (MHz)	Tested Line	Injection Method.	Test Result	Remark
10	0.15 – 80	AC line	Current Probe	A	RS485
10	0.15 – 80	DC line	Current Probe	A	RS485
10	0.15 – 80	PE line	CDN-M1	A	RS485
10	0.15 – 80	AC	Current Probe	A	MBUS
10	0.15 – 80	DC line	Current Probe	A	MBUS
10	0.15 – 80	PE line	CDN-M1	A	MBUS

Note#1: Tested Israel SII Frequencies 0.2,0.53,1,1.5,7.1,13.56,21,27.12,40.68,65,68 MHz

NOTE: A: There was no change compared with initial operation during the test.



4.7 POWER FREQUENCY MAGNETIC FIELD IMMUNITY TEST (EN IEC 61000-6-2)

4.7.1 TEST SPECIFICATION

Basic Standard:	IEC 61000-4-8
Frequency Range:	50Hz
Field Strength:	30A/m
Observation Time:	2 minute
Inductance Coil:	Rectangular type, 1.5mx1.5m

4.7.2 TEST INSTRUMENTS

Equipment	Manufacturer	Model No.	Serial No.	Last Cal.	Next Cal.
Power source	EMTEST	NET Wave 7	V1129110285	2019/01/23	2020/01/22
Helmholtz coil	EMTEST	HHS 5215-100	5215-100 102	2019/01/23	2020/01/22
Power source	EMTEST	NET Wave 7	V1129110285	2020/08/29	2021/08/28
Helmholtz coil	EMTEST	HHS 5215-100	5215-100 102	2020/08/29	2021/08/28

NOTE: 1. The test was performed by witness in BF-59 room of ShangHai Huawei Technology Co., Ltd.
2. The test was performed in BF-59 Room.

4.7.3 TEST PROCEDURE

- The equipment is configured and connected to satisfy its functional requirements.
- The power supply, input and output circuits shall be connected to the sources of power supply, control and signal.
- The cables supplied or recommended by the equipment manufacturer shall be used. 1 meter of all cables used shall be exposed to the magnetic field.

4.7.4 DEVIATION FROM TEST STANDARD

No Deviation



4.7.5 TEST SETUP

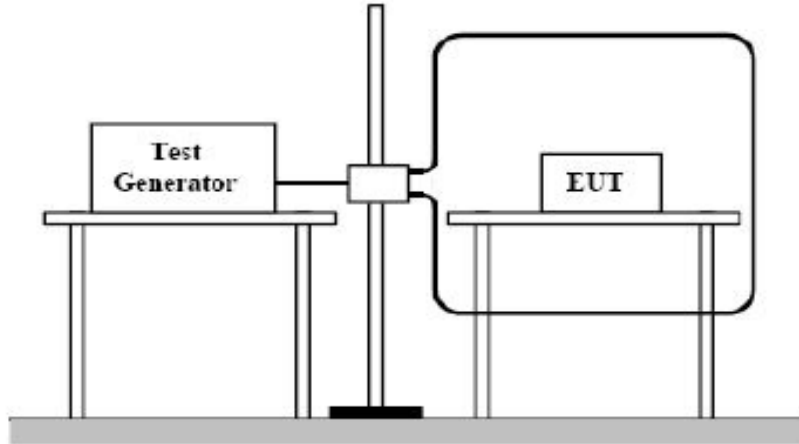

NOTE:

TABLETOP EQUIPMENT

The equipment shall be subjected to the test magnetic field by using the induction coil of standard dimension (1 m x 1 m). The induction coil shall then be rotated by 90 degrees in order to expose the EUT to the test field with different orientations.

FLOOR-STANDING EQUIPMENT

The equipment shall be subjected to the test magnetic field by using induction coils of suitable dimensions. The test shall be repeated by moving and shifting the induction coils, in order to test the whole volume of the EUT for each orthogonal direction. The test shall be repeated with the coil shifted to different positions along the side of the EUT, in steps corresponding to 50 % of the shortest side of the coil. The induction coil shall then be rotated by 90 degrees in order to expose the EUT to the test field with different orientations.



4.7.6 TEST RESULTS

TEST MODE	Mode A & Mode C	TEST VOLTAGE	DC 600V AC 400V & DC 600V AC 480V
ENVIRONMENTAL CONDITIONS	21deg. C, 55% RH	TESTED BY: Wang Jia	

MAGNETIC FIELD DIRECTION	TESTING RESULT	REMARK
X - Axis	A	30A/ m
Y - Axis	A	30A/ m
Z - Axis	A	30A/ m

TEST MODE	Mode B & Mode D	TEST VOLTAGE	DC 0V AC 400V & DC 0V AC 480V
ENVIRONMENTAL CONDITIONS	21deg. C, 55% RH	TESTED BY: Wang Jia	

MAGNETIC FIELD DIRECTION	TESTING RESULT	REMARK
X - Axis	A	30A/ m
Y - Axis	A	30A/ m
Z - Axis	A	30A/ m

NOTE: A: There is no change compared with the initial operation during the test.



4.8 VOLTAGE DIP/SHORT INTERRUPTIONS/VOLTAGE VARIATIONS (DIP) IMMUNITY TEST (EN62920)

4.8.1 TEST SPECIFICATION

Basic Standard:	IEC 61000-4-34
Test Duration Time:	Minimum three test events in sequence
Interval between Event:	Minimum ten seconds
Phase Angle:	0° / 180°
Test Cycle:	3 times

4.8.2 TEST INSTRUMENTS

Equipment	Manufacturer	Model No.	Serial No.	Last Cal.	Next Cal.
AC DIP simulator	EMTEST	PFS 503N32	0382-0371	2019/07/05	2020/07/04
Power Source	EMTEST	NET Wave 30	0352-0049	2019/07/05	2020/07/04
AC DIP simulator	Teseq	NSG1007-30	1128A03397	2020/08/28	2021/08/27
Power Source	Teseq	NSG 2200-3	EK A19422	2020/04/27	2021/04/26

- NOTE:** 1. The test was performed by witness in Shanghai Testing & Inspection Institute for Electrical Equipment.
 2. The calibration interval of the above test instruments is 12 months and the calibrations are traceable to CEPREI/CHINA, GRGT/CHINA and NIM/CHINA.

4.8.3 TEST PROCEDURE

The EUT shall be tested for each selected combination of test levels and duration with a sequence of three dips/interruptions with intervals of 10 s minimum (between each test event). Each representative mode of operation shall be tested. Abrupt changes in supply voltage shall occur at zero crossings of the voltage waveform.

4.8.4 DEVIATION FROM TEST STANDARD

No deviation.



4.8.5 TEST SETUP

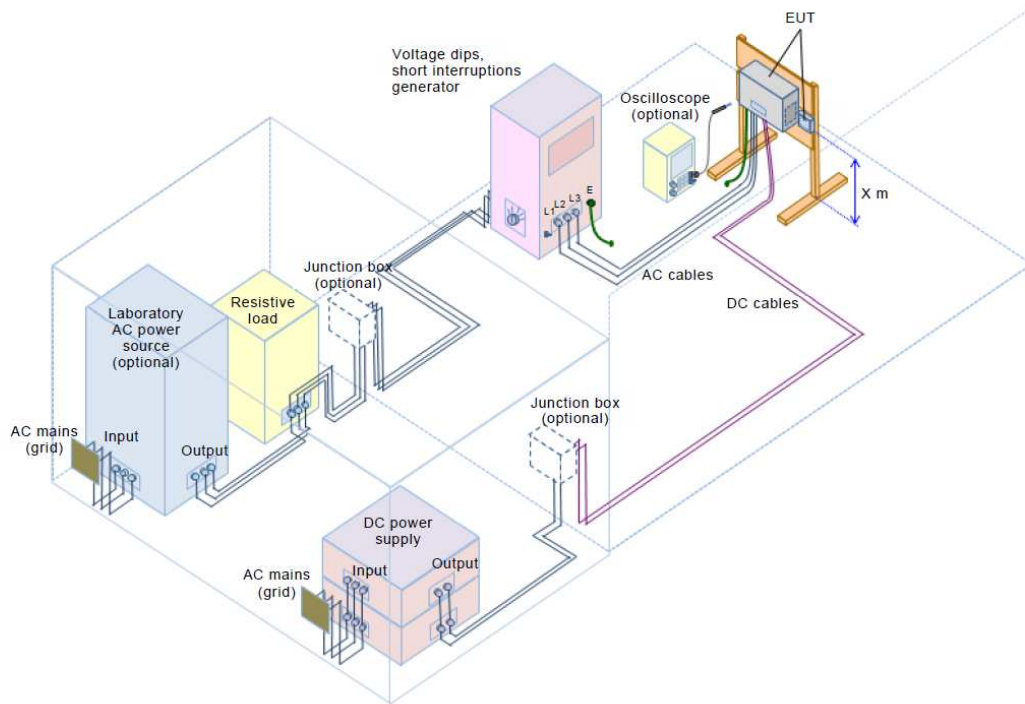

IEC

Figure A.9 – Example of a test setup using a generator for voltage dips and short interruptions



4.8.6 TEST RESULTS

TEST MODE	Mode A & Mode C	TEST VOLTAGE	DC 600V AC 400V
ENVIRONMENTAL CONDITIONS	21deg. C, 55% RH	TESTED BY: Wang Jia	

Ut : 400 Vac 50 Hz Voltage dips (%)	Durations		Event interval (sec)	Total events (time)	Test result
	(period)	(ms)			
0	1	20	10	3	A
40	10	200	10	3	A
70	25	500	10	3	A
0	250	5000	10	3	B

TEST MODE	Mode B & Mode D	TEST VOLTAGE	DC 0V AC 400V
ENVIRONMENTAL CONDITIONS	21deg. C, 55% RH	TESTED BY: Wang Jia	

Ut : 400 Vac 50 Hz Voltage dips (%)	Durations		Event interval (sec)	Total events (time)	Test result
	(period)	(ms)			
0	1	20	10	3	A
40	10	200	10	3	A
70	25	500	10	3	A
0	250	5000	10	3	B

NOTE: A: There was no change compared with initial operation during the test.
 B: The EUT stopped operation when at the 100% voltage interruption, but it can recover by itself.



5 PHOTOGRAPHS OF THE TEST CONFIGURATION

CONDUCTED EMISSION TEST (AC Power Port)

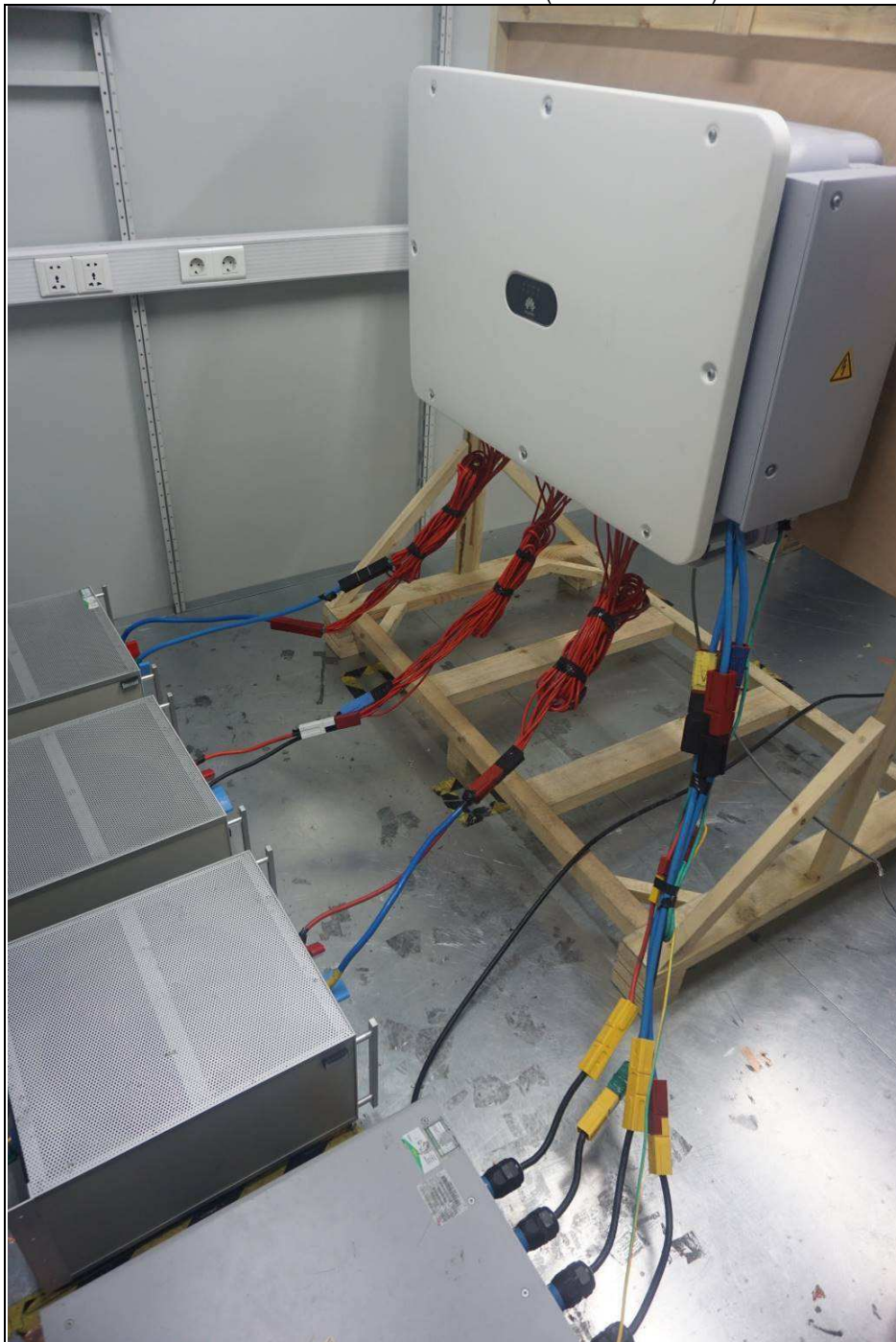



**BUREAU
VERITAS**

Test Report No.: CE2312WDG0186

CONDUCTED EMISSION TEST (DC Power Port)



**Bureau Veritas Shenzhen Co., Ltd.
Dongguan Branch**

No. 96, Guantai Road (Houjie Section), Houjie
Town, Dongguan City, Guangdong Province.
523942. People's Republic of China

Tel: +86 769 8998 2098
Fax: +86 769 8593 1080
Email: customerservice.dg@bureauveritas.com



CONDUCTED EMISSION TEST (Telecom port-RS485)

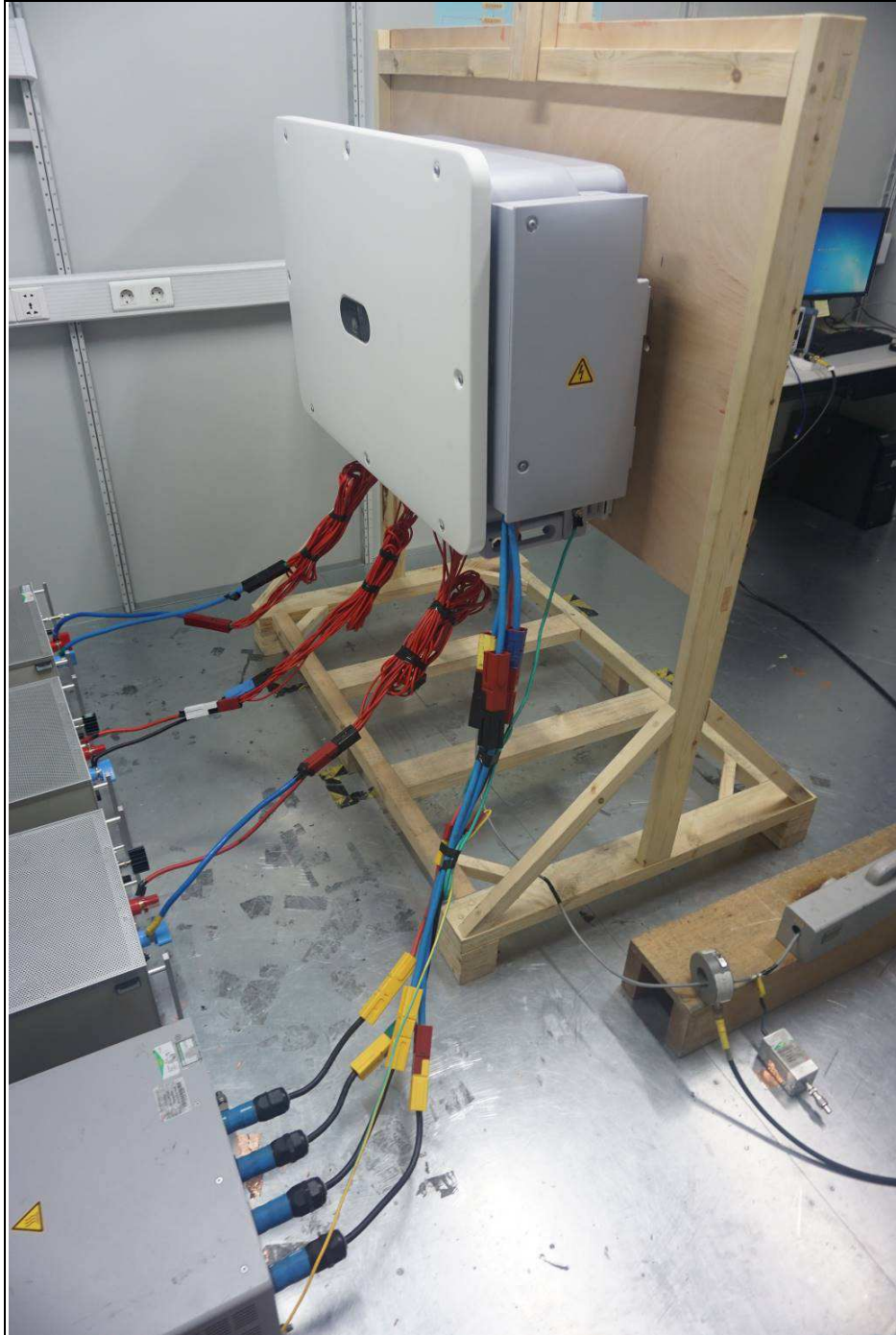



**BUREAU
VERITAS**

Test Report No.: CE2312WDG0186

RADIATED EMISSION TEST



HARMONICS EMISSION TEST & VOLTAGE FLUCTUATIONS AND FLICKER TEST

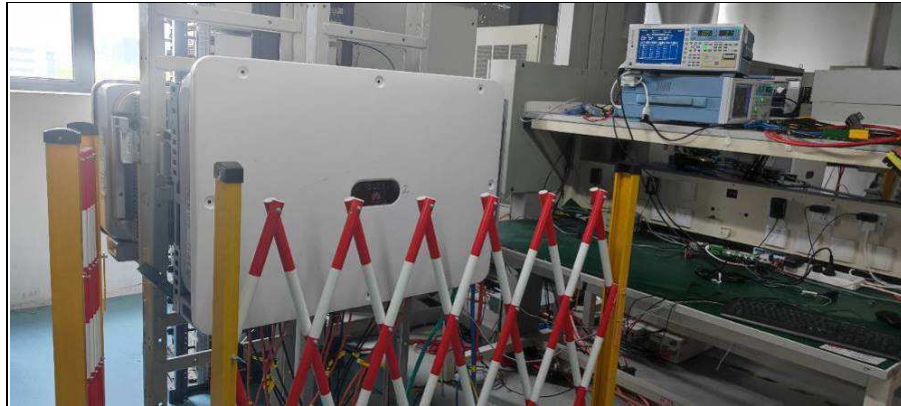

**Bureau Veritas Shenzhen Co., Ltd.
Dongguan Branch**

No. 96, Guantai Road (Houjie Section), Houjie
Town, Dongguan City, Guangdong Province.
523942. People's Republic of China

Tel: +86 769 8998 2098
Fax: +86 769 8593 1080
Email: customerservice.dg@bureauveritas.com



**BUREAU
VERITAS**

Test Report No.: CE2312WDG0186

ESD TEST

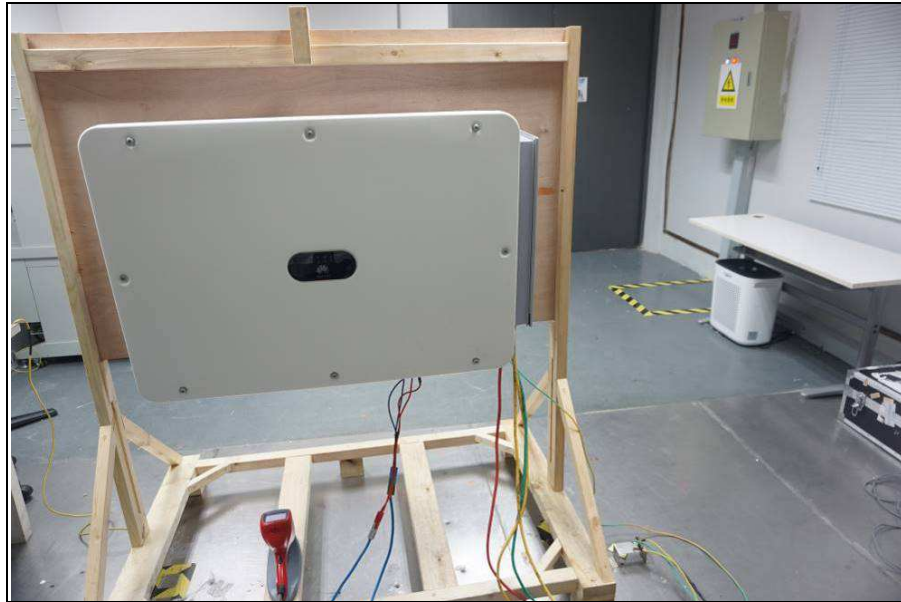

RS TEST



**Bureau Veritas Shenzhen Co., Ltd.
Dongguan Branch**

No. 96, Guantai Road (Houjie Section), Houjie
Town, Dongguan City, Guangdong Province.
523942. People's Republic of China

Tel: +86 769 8998 2098
Fax: +86 769 8593 1080
Email: customerservice.dg@bureauveritas.com



EFT TEST (AC Power Port)

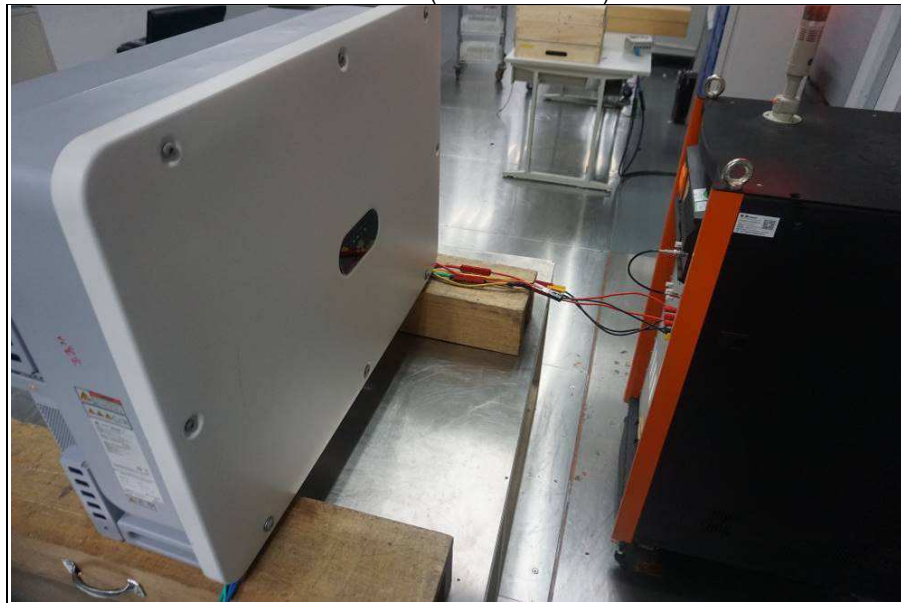



**BUREAU
VERITAS**

Test Report No.: CE2312WDG0186

EFT TEST (DC Power Port)



**Bureau Veritas Shenzhen Co., Ltd.
Dongguan Branch**

No. 96, Guantai Road (Houjie Section), Houjie
Town, Dongguan City, Guangdong Province.
523942. People's Republic of China

Tel: +86 769 8998 2098
Fax: +86 769 8593 1080
Email: customerservice.dg@bureauveritas.com



EFT TEST (RS485 Cable)



SURGE TEST (AC Power Port)





**BUREAU
VERITAS**

Test Report No.: CE2312WDG0186

SURGE TEST (DC Power Port)



**Bureau Veritas Shenzhen Co., Ltd.
Dongguan Branch**

No. 96, Guantai Road (Houjie Section), Houjie
Town, Dongguan City, Guangdong Province.
523942. People's Republic of China

Tel: +86 769 8998 2098
Fax: +86 769 8593 1080
Email: customerservice.dg@bureauveritas.com



SURGE TEST (RS485 Cable)



CONDUCTED SUSCEPTIBILITY TEST (DC Power Port)





CONDUCTED SUSCEPTIBILITY TEST (AC Power Port)

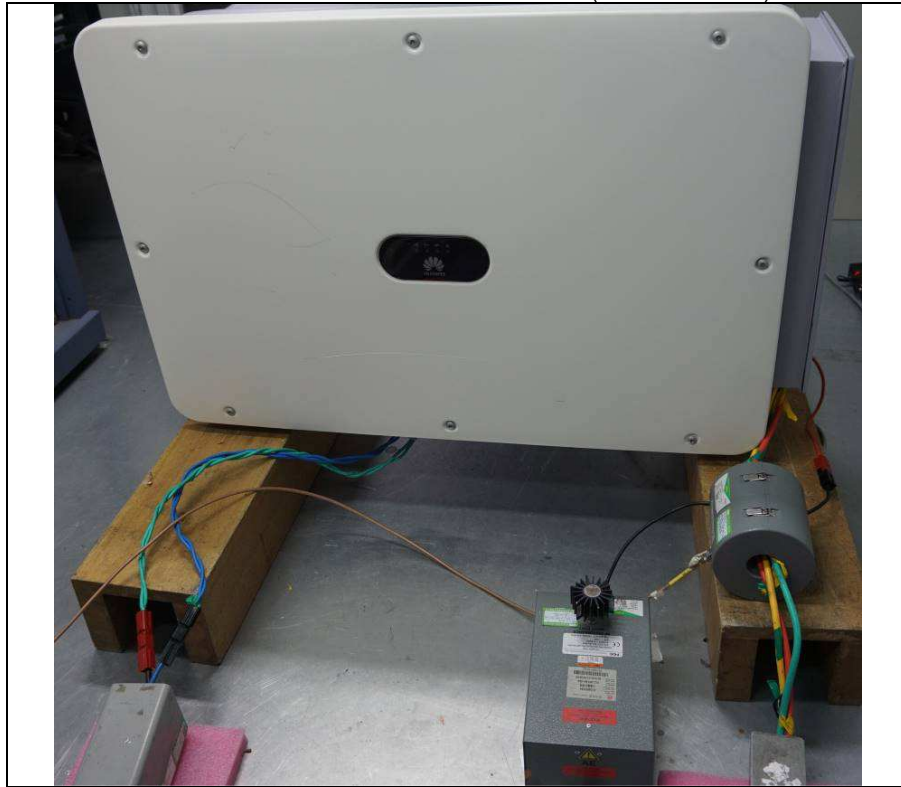

CONDUCTED SUSCEPTIBILITY TEST (RS485 Cable)





**BUREAU
VERITAS**

Test Report No.: CE2312WDG0186

CONDUCTED SUSCEPTIBILITY TEST (PE)

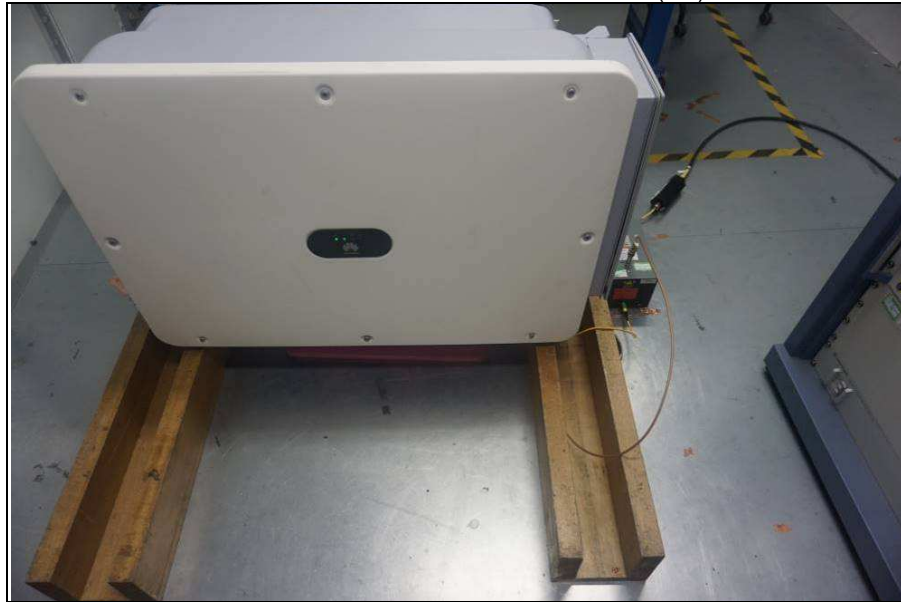

DIPS TEST



**Bureau Veritas Shenzhen Co., Ltd.
Dongguan Branch**

No. 96, Guantai Road (Houjie Section), Houjie
Town, Dongguan City, Guangdong Province.
523942. People's Republic of China

Tel: +86 769 8998 2098
Fax: +86 769 8593 1080
Email: customerservice.dg@bureauveritas.com



**BUREAU
VERITAS**

Test Report No.: CE2312WDG0186

POWER-FREQUENCY MAGNETIC FIELDS TEST



**Bureau Veritas Shenzhen Co., Ltd.
Dongguan Branch**

No. 96, Guantai Road (Houjie Section), Houjie
Town, Dongguan City, Guangdong Province.
523942. People's Republic of China

Tel: +86 769 8998 2098
Fax: +86 769 8593 1080
Email: customerservice.dg@bureauveritas.com



Test Report No.: CE2312WDG0186

6 APPENDIX A – MODIFICATIONS RECORDERS FOR ENGINEERING CHANGES TO THE EUT BY THE LAB

No any modifications were made to the EUT by the lab during the test.

---END---