

Battery-Box Combiner Box Plus CBH-70A

Installation Manual

Contents

1 Information on this Document	2
1.1 Validity	2
1.2 Target Group	2
1.3 Content and Structure of this Document	2
1.4 Declaration of Conformity	2
1.5 Levels of Warning Messages	2
2 Safety	3
2.1 Position and Securing	3
2.2 Safety Precautions	3
3 Scope of Delivery	4
4 Product Description	4
4.1 Circuit Diagram	4
4.2 Product Appearance	4
4.3 Type Label	5
4.4 Symbols on the Type Label	5
5 Installation	6
5.1 Tools & Additional Accessories (not included in the scope of delivery)	6
5.2 Installation Environment	6
5.3 Combiner Box Installation	7
5.3.1 Wall Mounting	7
5.3.2 Electrical Connection	7
5.3.2.1 PE Connection	7
5.3.2.2 Battery Connection	8
5.3.2.3 Inverter Connection	8
5.3.2.4 Systems Connection	9
6 Storage	10
7 Maintenance	10
8 Decommissioning	10
8.1 Disassembling the Combiner Box	10
8.2 Disposing of the Combiner Box	11
9 Technical Data	11
10 Contact Information	12

Legal Provisions

All information in this document is the property of BYD Company Limited and no part of this document may be reproduced in any manner for commercial use.

BYD makes no representations or warranties, express or implied, with respect to this document or any equipment and / or software that may be described in it, including (without limitation) any implied warranties of utility, merchantability or fitness for any particular purpose, and all such representations or warranties are expressly disclaimed. In no event shall BYD or its distributors or dealers be liable for any indirect, incidental or consequential damages.

Under some statutes, the exclusion of implied warranties may not apply in all cases, so the above exclusion may not apply.

Before transporting, storing, installing, operating, using, deactivating, or / and maintaining the equipment, please read this installation manual, strictly follow the contents of the installation manual, and follow all safety precautions indicated on the equipment and in the installation manual. In this installation manual, "equipment" refers to the products, software, components, spare parts, and/or services related to this installation manual.

The "Danger", "Warning", "Caution", and "Notice" items in the installation manual do not represent all the safety precautions that should be followed. You also need to comply with relevant international, national, or regional standards, as well as industry practices.

This equipment should be used in an environment that meets the design specifications. Otherwise, equipment failures, abnormal equipment functions, or component damage that may occur are not within the scope of equipment quality assurance; Otherwise, Shenzhen BYD Electronics Co., Ltd. shall not be liable for compensation for potential personal injury, property damage, etc.

All operations such as transportation, storage, installation, operation, use, shutdown, and maintenance should comply with applicable laws, regulations, standards, and specifications.

Reverse engineering, decompilation, disassembly, adaptation, implantation, or other derivative operations of device software are prohibited. It is not allowed to study the internal implementation logic of the device, obtain the source code of the device software, or infringe intellectual property rights in any way. It is also not allowed to disclose the results of any device software performance testing.

This document does not supersede and is not intended to supersede any local, state, provincial, federal, or national laws, regulations, or codes applicable to the installation, electrical safety, and use of the battery module. BYD is not responsible for compliance or non-compliance with such laws or regulations when installing the battery module.

Specifications are subject to change without notice. Every effort has been made to keep this document complete, accurate and current.

However, without advance notice, BYD may need to make some improvements in specific situations. BYD shall not be liable for any damage caused by this document, including but not limited to omissions, errors, typographical errors, miscalculations, or tabulation errors in this document.

All trademarks are recognized.

Limited Warranty Letter

You can download the latest warranty documents from the www.bydenergy.com on the Internet.

Product Datasheet

You can download the latest product datasheet from the www.bydenergy.com on the Internet.

Service Guide

You can download the latest Service Guide from a www.bydenergy.com on the Internet.

BYD Company Limited

3009, BYD Road, Pingshan, Shenzhen, P.R.China.

Manufacturer

Shanwei BYD Auto Co., Ltd.

1 Information on this Document

DISCLAIMER

When installing, operating, and maintaining the equipment, read this manual first and adhere to all safety precautions on the equipment and in the manual. BYD shall not be liable if any of the following situations occur.

- Operation outside the conditions specified in this manual.
- Installation or operating environments that do not comply with relevant international, national, or regional standards.
- Unauthorized disassembly, product modification.
- Failure to operate according to the safety instructions and precautions on the product and in the manual.
- Damages caused by abnormal natural environments (force majeure, such as earthquakes, fires, windstorms, floods, mudslides, etc.).
- Damages caused during customer transport.
- Damages caused by storage conditions that do not meet the requirements specified in the manual.
- Damages to hardware or data due to customer negligence, improper operation, or intentional damage.
- Damages to the system caused by a third party or the customer, including damages from improper transport or installation not complying with this manual, as well as unauthorized adjustment, alteration, or removal of identification signs.

Reverse engineering, decompiling, disassembling, adapting, implanting, or performing other derivative operations on the equipment's software is prohibited.

1.1 Validity

This document is valid for the Battery-Box Combiner Box Plus CBH-70A.

1.2 Target Group

The instructions in this document may only be performed by qualified persons who must have the following skills:

- Knowledge of how batteries work and are operated.
- Knowledge of how an inverter works and is operated.
- Knowledge of, and adherence to the locally applicable connection requirements, standards, and directives.
- Knowledge of, and adherence to this document and the associated system documentation, including all safety instructions.
- Training in dealing with the hazards associated with the installation and operation of electrical equipment and batteries.
- Training in the installation and commissioning of electrical equipment.

Failure to do so will make any manufacturer's warranty, guarantee or liability null, and void unless you can prove that the damage was not due to non-compliance.

1.3 Content and Structure of this Document

This document contains safety information and instructions, scope of delivery, Combiner Box overview, installation, electrical connection, commissioning, operation, decommissioning, maintenance and storage, technical parameters. Please finish reading this document before taking any actions on the Combiner Box.

1.4 Declaration of Conformity

The certificate of Battery-Box Combiner Box Plus is available in the download area at www.bydenenergy.com.

1.5 Levels of Warning Messages

⚠ DANGER
Indicates a high-level hazard that, if not avoided, will result in death or serious injury.
⚠ WARNING
Indicates a medium-level hazard that, if not avoided, could result in death or serious injury.
⚠ CAUTION
Indicates a low-level hazard that, if not avoided, could result in minor or moderate injury.
NOTICE
Highlight and supplement the texts. Or some skills and methods to solve product-related problems to save time.

2 Safety

Failure to follow these instructions may have serious consequences, such as the destruction of the device, personal injury or death due to electric shock. Therefore, the following safety instructions must be read and understood prior to installation and use of the Combiner Box. For any clarifications or additional information, contact the BYD local service.

2.1 Position and Securing

NOTICE

- If positioning in a closed environment, make sure the area is ventilated and allows regular recirculation of air. If installing in an open environment, position the enclosure in an area that is constantly shaded and protected from exposure to direct sunlight. These measures are important for preventing unnecessary and excessive overheating, which prolonged in time impairs the duration and operation of parts inserted inside.
- Make sure the wall where the enclosure is to be mounted is suitable to support the weight. The weight is around 8 kg.
- Verify the Combiner Box's IP65 rating meets environmental requirements.

2.2 Safety Precautions

This section contains safety precautions that must be observed at all times when working on or with the product. To prevent personal injury and property damage and to ensure long-term operation of the product, read this section carefully and follow all safety precautions at all times.

DANGER

- Disconnect power before any maintenance or inspection. Always verify the equipment is in a safe condition (de-energized) before proceeding.
- Use insulated tools and professional instruments. Employ insulated tools to prevent electric shock. Utilize professional-grade measurement instruments to accurately test current and voltage.
- Qualified personnel only. Operators must possess relevant qualifications, have a thorough understanding of the Combiner Box's operating principles and safety procedures to prevent operational errors.

Danger to life from electric shock due to live voltage

High voltages are present in the live components of the Combiner Box. Touching live components results in death or serious injury due to electric shock.

- Wear personal protective equipment when working on the Combiner Box.
- Do not touch live components.
- Before performing any work, always disconnect the Combiner Box from voltage sources unless supply voltage is absolutely necessary.
- Ensure that the device cannot be reconnected.
- Ensure that no voltage is present.
- Ground and short-circuit.
- Cover or isolate any adjacent live components. Protective covers must always be mounted.

Danger to life from electric shock due to live DC cables

Touching live DC cables from batteries or an inverter results in death or serious injury.

- Prior to connecting the DC cables, ensure that the DC cables are voltage-free.
- Wear suitable personal protective equipment when working on the Combiner Box.

Danger to life from electric shock if the Combiner Box is damaged

If the Combiner Box is damaged, dangerous situations may arise during operation that results in death or serious injury from electric shock.

- Only use the Combiner Box when it is in a technically faultless condition and safe to operate.
- Regularly check the Combiner Box for visual damage.
- Make sure that all external safety equipment is freely accessible at all times.
- Make sure that all safety equipment is in good working order.

3 Scope of Delivery

Check the scope of delivery for completeness and any externally visible damage. Contact your distributor if the scope of delivery is incomplete or damaged.

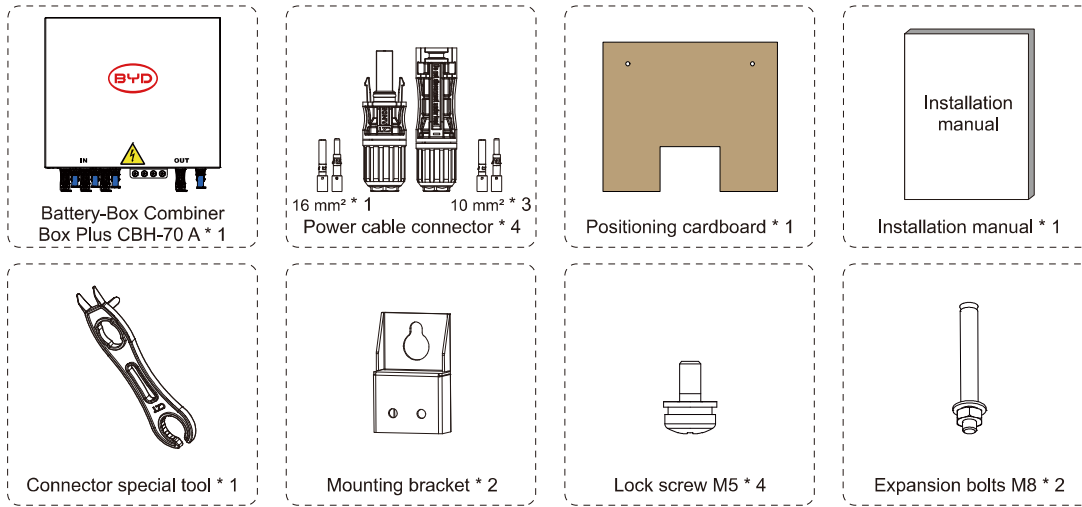

4 Product Description

4.1 Circuit Diagram

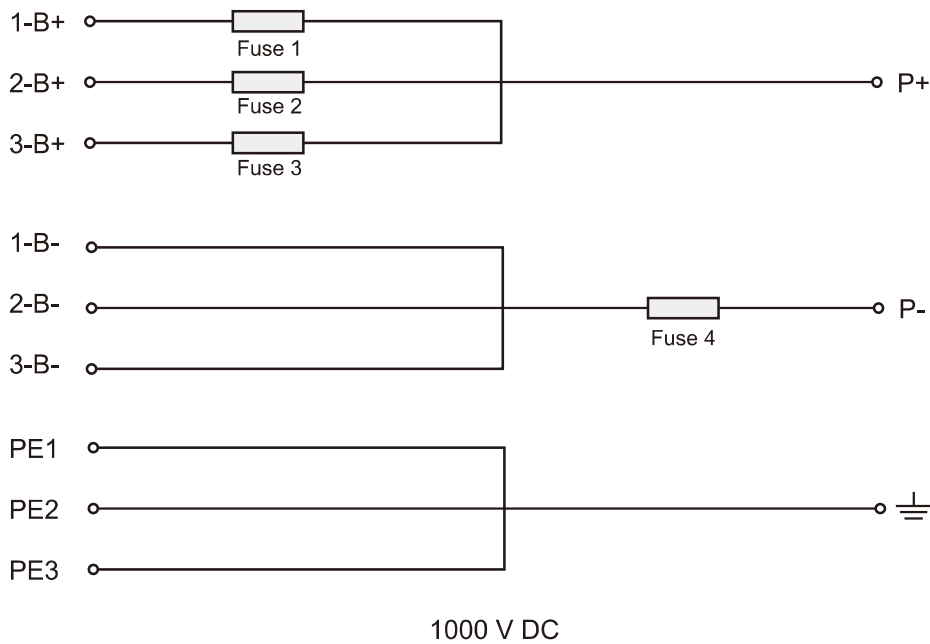

4.2 Product Appearance

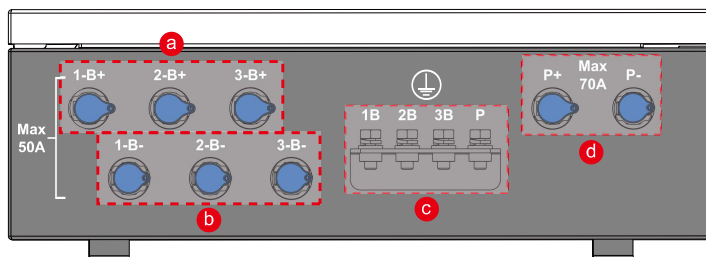



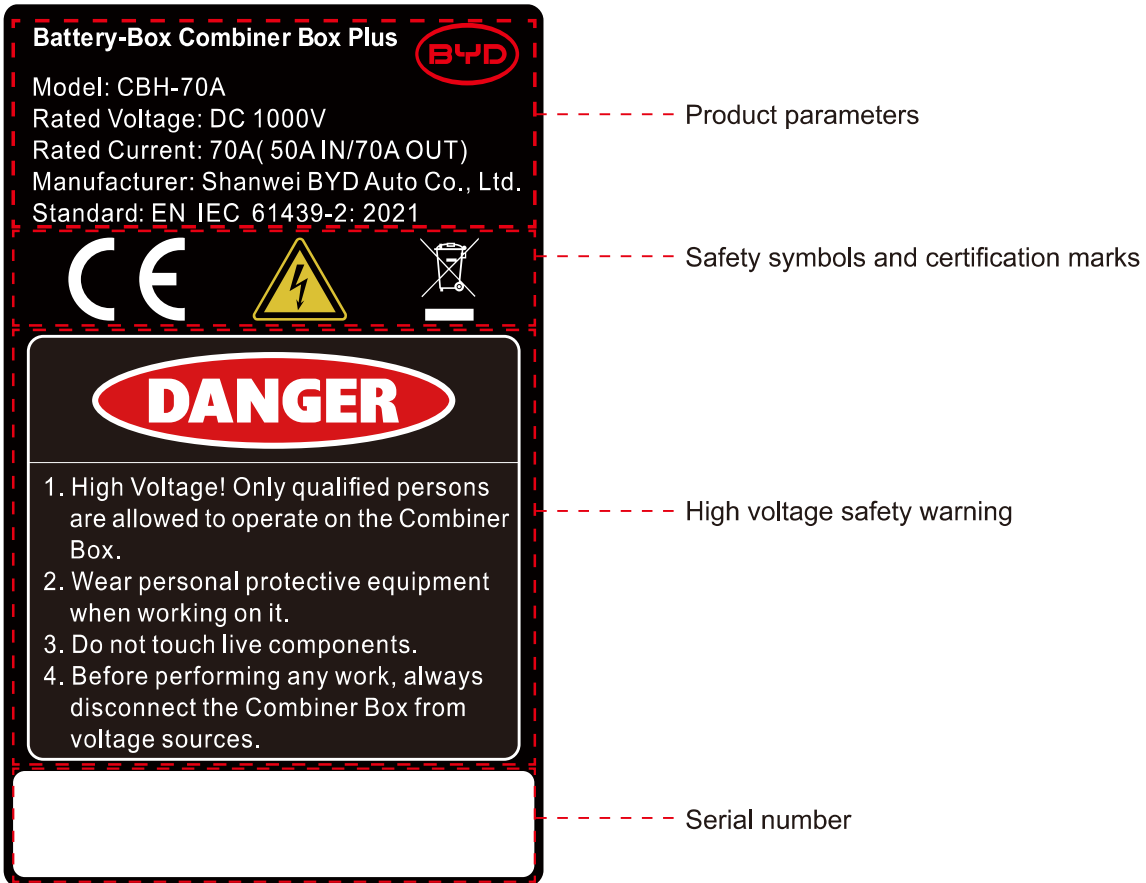

- a** Bat+ terminals for connecting positive power cables from battery towers
- b** Bat- terminals for connecting positive power cables from battery towers
- c** Grounding cables
- d** Output DC cable glands to an inverter

4.3 Type Label



4.4 Symbols on the Type Label

Icon	Item	Description
	CE mark	This product complies with CE certification.
	Warning mark	Combiner Box operates at high voltage. All operations must be performed by well-trained professional electrical technicians.
	EU WEEE mark	If the user intends to discard this product, it must be sent to an appropriate place for recovery and recycling, which cannot be disposed of as domestic waste.
	Danger mark	Indicates a hazardous situation which, if not avoided, will result in death or serious injury.

5 Installation

5.1 Tools & Additional Accessories (not included in the scope of delivery)

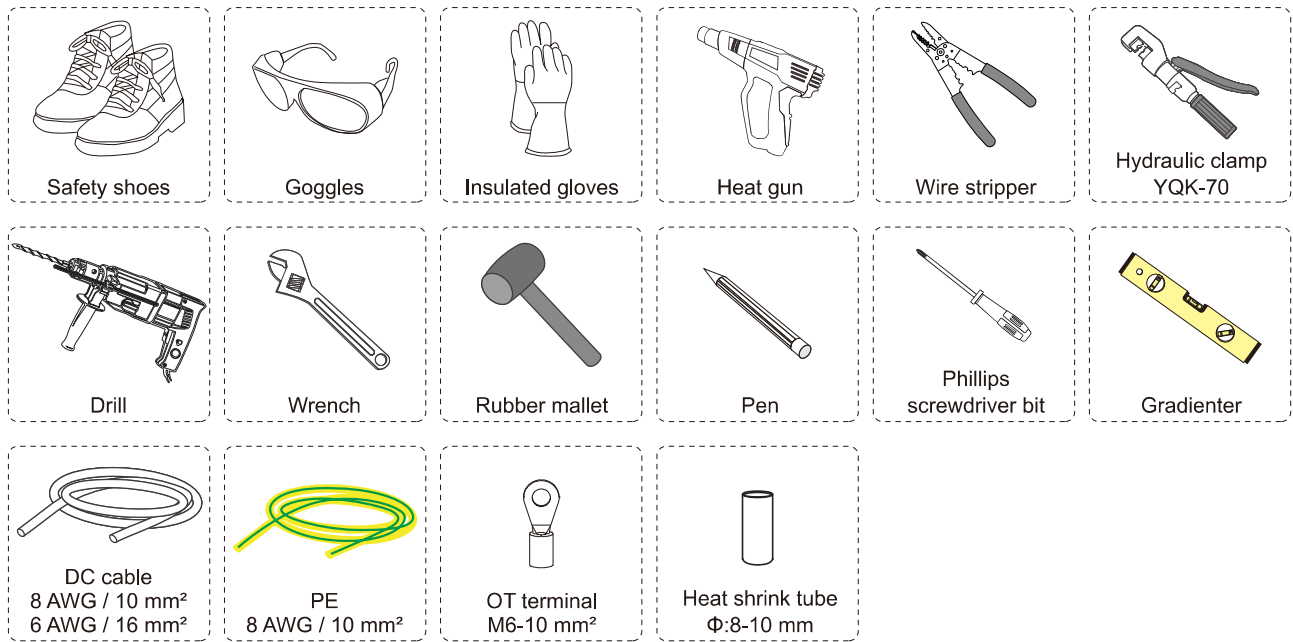

5.2 Installation Environment

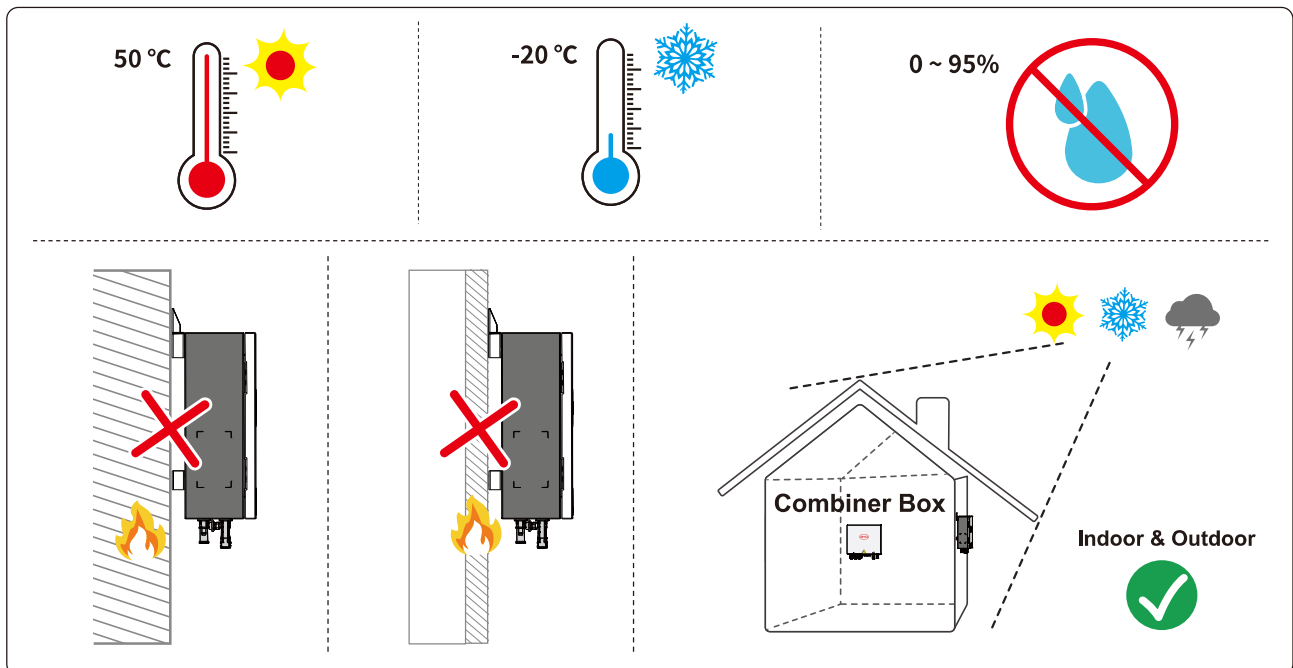

5.3 Combiner Box Installation

5.3.1 Wall Mounting

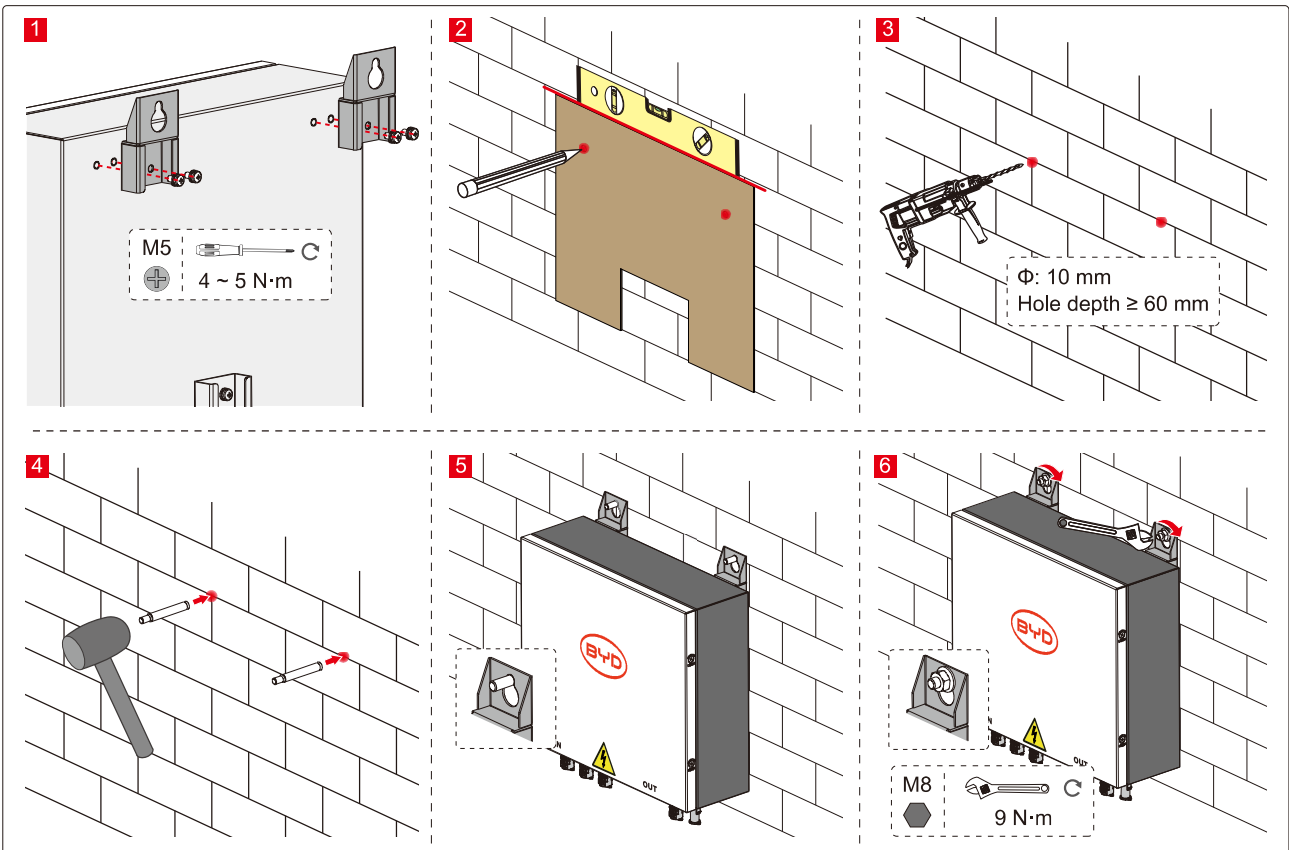

5.3.2 Electrical Connection

5.3.2.1 PE Connection

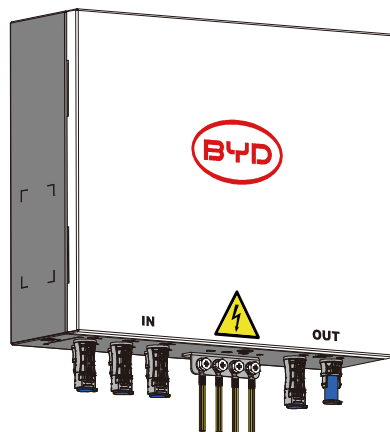

Cable Requirement
8 AWG / 10 mm²

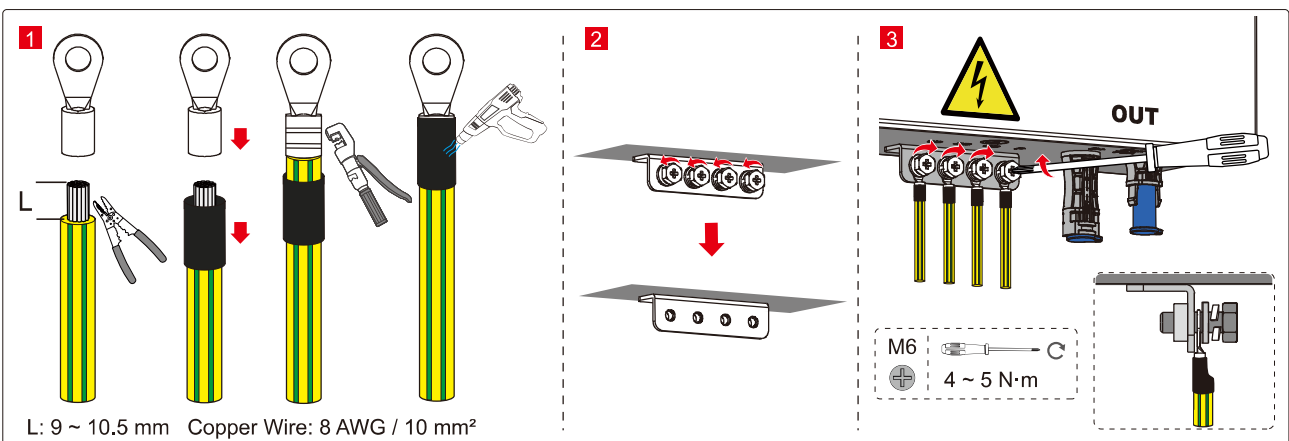

5.3.2.2 Battery Connection

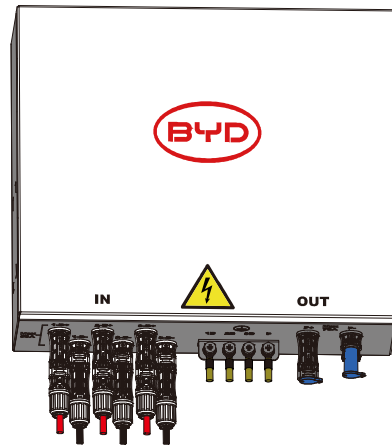

Cable Requirement
8 AWG / 10 mm²

1

L: 10 mm
Copper Wire: 10 mm² (B+ / B-)

2

Viewing Hole

YQK-70

3

Thin-walled side

Elastic piece

4

5

"Click"

6

⚠ When crimping terminals, the crimping pliers die must not completely cover the viewing hole.

⚠ The burrs need to be trimmed. After trimming, they should not be higher than the right flange, and there should be no broken edges or wire core leakage.

⚠ 1. Any elastic piece of the terminal must be aligned with the thin-walled side of the plastic case opening before insertion.
2. After inserting, please try pulling it out to check if the terminal and the plastic case are securely connected.

5.3.2.3 Inverter Connection

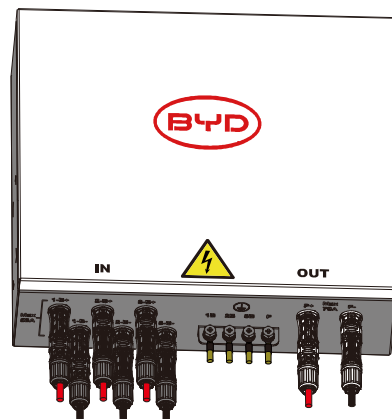

Cable Requirement
6 AWG / 16 mm²

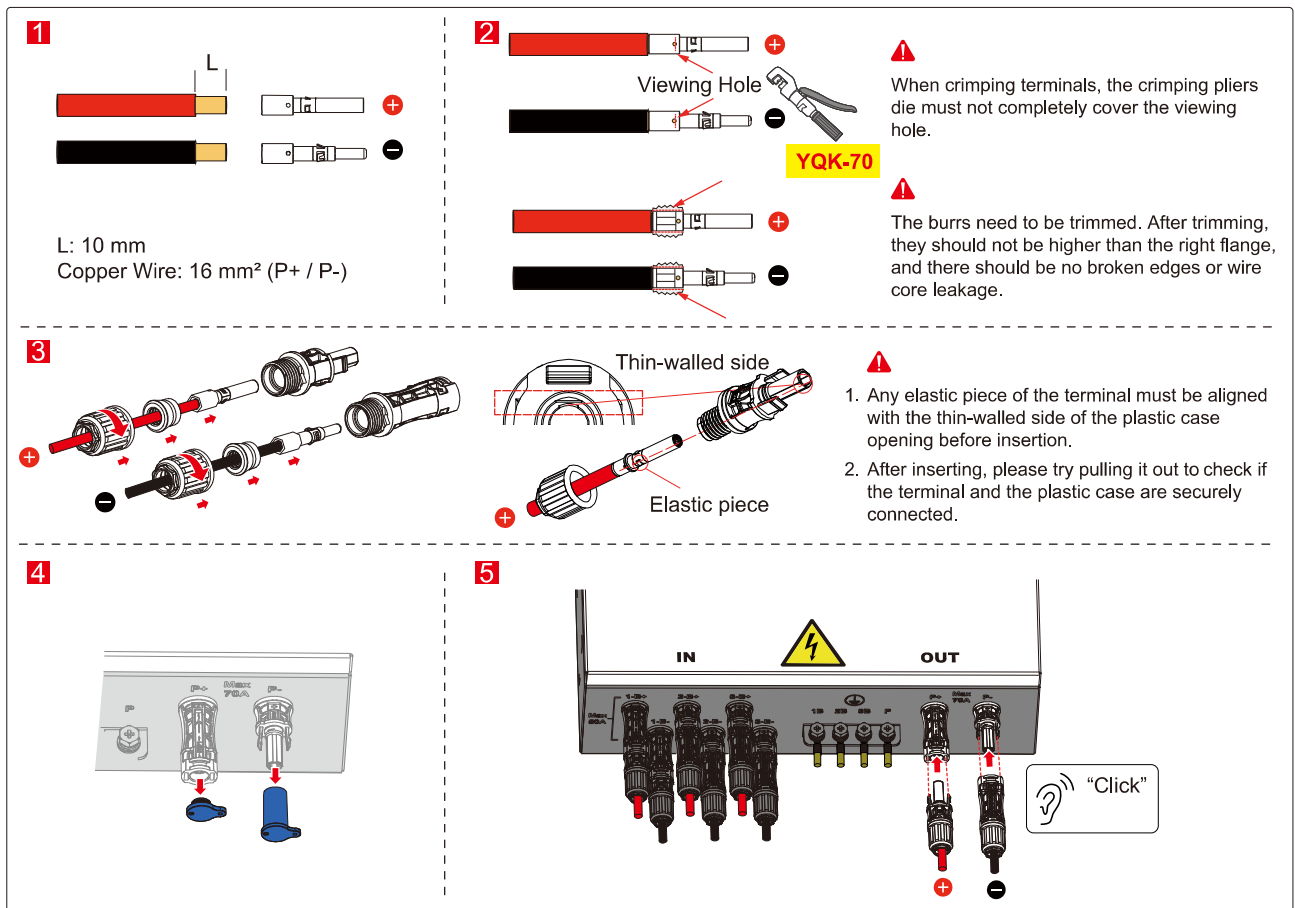

5.3.2.4 Systems Connection

⚠ CAUTION

- The Battery-Box Combiner Box Plus can be used with the BYD Battery-Box HVS / HVM / HVB / HVM+ / HVS+ / HVE.
- Make sure the planned configuration meets the Premium HV Compatible Inverter list by BYD.
- The Towers have the same module quantity. Battery Towers of different models cannot be mixed.
- The SOC should be the same among all towers upon installation.

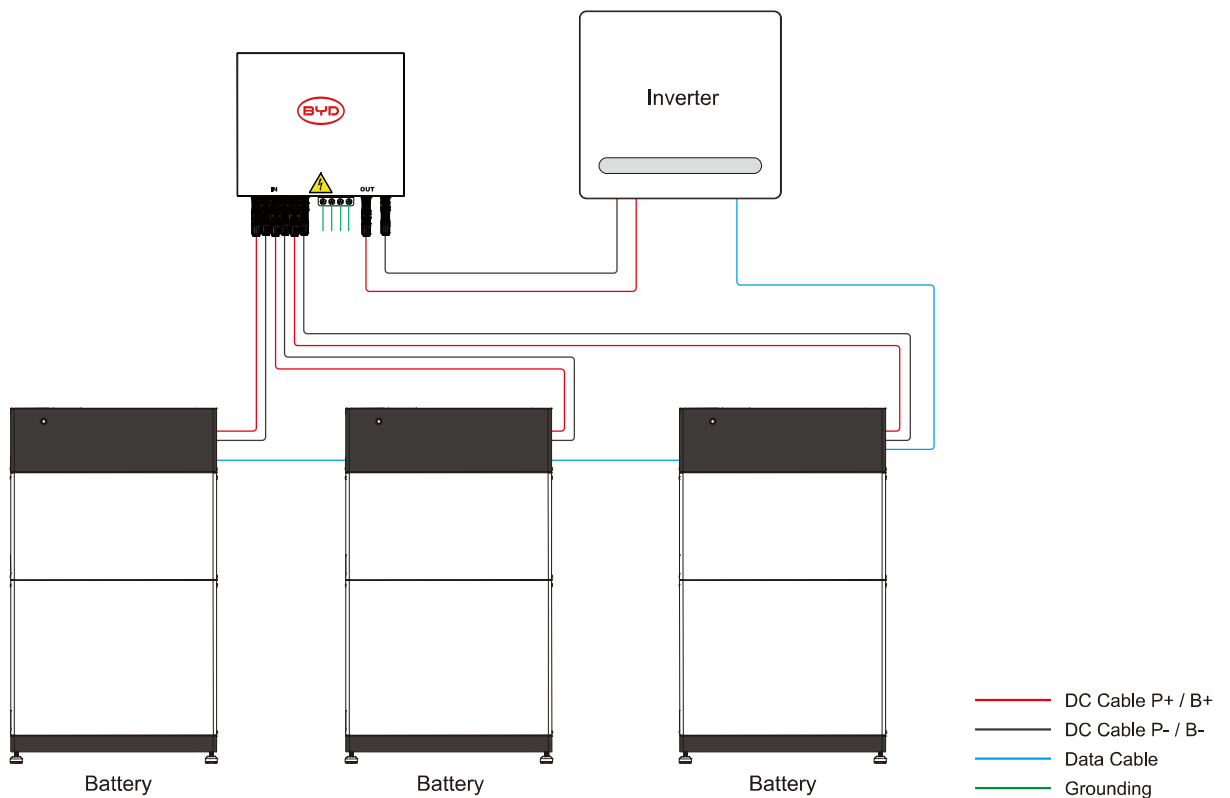

6 Storage

⚠ WARNING

- The Combiner Box must be stored indoors, and the package of the Combiner Box must be intact. It is strictly prohibited to store the products without packaging. Otherwise, BYD shall not assume any liability for the damage to the Combiner Box, the shortening in service life or other losses caused by such storage condition.

The product must be stored in a clean, dry, well-ventilated warehouse where the ambient temperature is maintained between -5°C and 35°C, relative humidity does not exceed 75%, and exposure to direct sunlight or corrosive gases is strictly avoided. Always store the product upright; never invert or lay it flat. Protect it from mechanical impacts, heavy pressure, and contact with corrosive substances.

7 Maintenance

⚠ CAUTION

- Do not perform maintenance on the equipment unless you are familiar with the contents of this manual and have the proper tools and test equipment.
- Professional technicians and operators shall be fully trained and have knowledge of safe operation and maintenance of the equipment. They should take adequate precautions and personal protective equipment while operating.
- The unit cannot be powered up again until all faults have been resolved. Failure to do so may result in more problems or damage to the device.
- Do not open the cover without authorization, otherwise there is a risk of electric shock.

It is recommended to periodically inspect the panel and check the following points:

Maintenance Item	Interval	Process
Monitor Operating Status	yearly	Check the Combiner Box for signs of abnormal heating, unusual odors, or physical damage. Promptly identify and address potential issues.
Temperature Monitoring	yearly	Check the Combiner Box temperature to prevent overheating. Inspect for loose connections or potential overload conditions
Regular Cleaning	yearly	Remove dust and debris from the Combiner Box exterior. Maintain good ventilation to prevent overheating caused by accumulated dirt.
Terminal Inspection	yearly	Check all wiring terminals for oxidation, corrosion, or looseness. Clean, tighten, or replace terminals as necessary to ensure optimal electrical conductivity.
Seal Inspection	yearly	Check the condition of the Combiner Box sealing gasket. Replace it promptly if aged or damaged to prevent moisture ingress.

8 Decommissioning

8.1 Disassembling the Combiner Box

⚠ DANGER

Danger to life due to electric shock when touching live components of the Combiner Box .

Observe the following safety rules when disconnecting:

- Turn off the inverter and battery switch in sequence to ensure that the system enters the shutdown state.
- The DC cables connected to the battery and inverter may be live. Do not touch non-insulated cable ends.
- Check if there is still voltage or current on the Combiner Box.
- Cover or isolate any adjacent live components.

⚠ CAUTION

- Risk of burns from touching hot components.

Steps:

1. Turn off the battery system.
2. Disconnect the input cables
3. Disconnect the output cables.
4. Disconnect the grounding cables.
5. Disassemble the Combiner Box.

8.2 Disposing of the Combiner Box

Dispose of the Combiner Box in accordance with the applicable disposal regulations for electronic waste.

9 Technical Data

Battery-Box Combiner Box Plus	
Model	CBH-70A
Supported Battery-Box Model	HVS / HVM / HVB / HVM+ / HVS+ / HVE
Max Connection of Towers	3
Max Input Current per Battery Tower	50 A
Max Output Current	70 A
Dimensions (W/D/H)	350 * 300 * 114.2 mm
Weight	8 kg
Installation Mode	Wall Mount
Max Operating Voltage	1000 V
Enclosure Protection Rating	IP65
Operating Temperature	-20 °C to +50 °C
Operating Humidity	0% ~ 95%RH, Non-Condensing
Cooling	Natural Convection
Altitude	< 4000 m
Warranty	10 Years
Certification	EN IEC 61439-1/2 IEC 61439-1/2 AS/NZS 61439-1/2 ROHS REACH POPS

10 Contact Information

Australia

Alps Power Pty Ltd service @ alpspower.com.au

☎ +61 2 8005 6688

📍 14/47-51 Lorraine St Peakhurst NSW 221 www.alpspower.com.au

Europe

EFT-Systems GmbH service @ eft-systems.de

☎ +49 9352 8523999 +44 (0) 2037695998(UK) +34 91 060 22 67(ES) +39 02 873683(IT)

📍 Bruchtannenstraße 28, 63801 Kleinostheim, Germany www.eft-systems.de



Shanwei BYD Auto Co., Ltd.